

AQUATIC RESOURCE DELINEATION REPORT

LAKEVIEW ESTATES (APN 051-411-20)
WATSONVILLE, SANTA CRUZ COUNTY, CALIFORNIA

MAY 2018

Prepared for:

Bryan Mori Biological Consulting Services
1016 Brewington Avenue
Watsonville, CA 95076
(831) 728-1043
moris4wildlife@earthlink.net

Prepared by:

Tom Mahony, MS, PWS
Certified Professional Wetland Scientist #2567
Coast Range Biological LLC
PO Box 1238
Santa Cruz, CA 95061
(831) 426-6226
coastrange@sbcglobal.net



TABLE OF CONTENTS

1.0 INTRODUCTION	1
2.0 METHODS	1
2.1 Hydrophytic Vegetation	1
2.2 Wetland Hydrology	3
2.3 Hydric Soils	3
2.4 Other Waters of the U.S.	4
2.5 Limitations.....	4
3.0 STUDY AREA DESCRIPTION	4
3.1 Vegetation.....	4
3.2 Geology, Climate, and Soils	5
3.3 Hydrology.....	7
4.0 RESULTS	7
4.1 Aquatic Resources	7
4.1.1 Potential Jurisdictional Wetlands	10
5.0 POTENTIAL CORPS JURISDICTION.....	11
6.0 REFERENCES	11

LIST OF FIGURES

Figure 1. Study Area Locality Map.	2
Figure 2. Topographic Map of the Study Area.	6
Figure 3. National Wetlands Inventory Map of the Study Area.	8
Figure 4. Delineation Map of the Lakeview Estates Study Area.....	9

LIST OF TABLES

Table 1. Wetland Plant Indicator Status.	3
Table 2. Aquatic Resources Delineated on the Study Area.	7

APPENDICES

Appendix A. Corps Delineation Data Forms	
Appendix B. Soil Map of the Study Area	
Appendix C. Photographs of the Study Area	
Appendix D. Plant Species Observed on the Study Area and their Wetland Indicator Status	

1.0 INTRODUCTION

Coast Range Biological LLC conducted an aquatic resource delineation to identify the location and extent of waters, including wetlands, potentially subject to jurisdiction by the U.S. Army Corps of Engineers (Corps) under Section 404 of the federal Clean Water Act (CWA) on the ~2.3-acre Lakeview Estates property (APN 051-411-20) located southeast of the intersection of Trembley Lane and Cunningham Way in unincorporated Watsonville, Santa Cruz County, California (“study area”) (Figure 1). The proposed project on the study area consists of construction of a nine-lot residential subdivision as shown on site plans, dated December 30, 2014, prepared by Roper Engineering.

The CWA gives the Corps and Environmental Protection Agency (EPA) jurisdiction over “waters of the United States” which include lakes, rivers, streams (including intermittent or ephemeral streams) and wetlands. “Wetlands” are jointly defined by the Corps and EPA as:

“Those areas that are inundated or saturated by surface or ground water at a frequency and duration sufficient to support, and that under normal circumstances do support, a prevalence of vegetation typically adapted for life in saturated soil conditions. Wetlands generally include swamps, marshes, bogs, and similar areas” (Federal Register 1980; Federal Register 1982).

2.0 METHODS

Prior to the field delineation, available reference materials were reviewed, including the Web Soil Survey (NRCS 2018a), the National Wetlands Inventory (USFWS 2018), the National Hydrography Dataset (USGS 2018), topographic maps (USGS 1954), geologic data (California Geological Survey 2010), aerial imagery, and project site plans. A routine-level jurisdictional delineation was conducted on the study area on May 22, 2018. The study area was field-checked for indicators of hydrophytic vegetation, wetland hydrology, and hydric soils. Thirteen sample points were taken on the study area and recorded on Corps data forms provided in the *Regional Supplement to the Corps of Engineers Wetland Delineation Manual: Arid West Region (Version 2.0)* (“Arid West Manual”) (USACE 2008a)¹. Corps data forms are presented in Appendix A.

This aquatic resource delineation was conducted in accordance with the Arid West Manual and the *Corps of Engineers Wetlands Delineation Manual* (Corps Manual) (Environmental Laboratory 1987). Based on the presence or absence of field indicators—including vegetation, hydrology and soils—the limits of potential jurisdictional wetlands and other waters of the U.S. were determined. Potential jurisdictional wetlands were mapped in the field with a Trimble GPS unit (sub-meter accuracy), differentially corrected, and overlain on a digital orthophoto (dated July 23, 2016, obtained from Santa Cruz County, data in UTM Zone 10, NAD 83 format) using ArcGIS mapping software.

2.1 Hydrophytic Vegetation

Hydrophytic vegetation is defined as “the sum total of macrophytic plant life that occurs in areas where the frequency and duration of inundation or soil saturation produce permanently or periodically

¹ The study area is located in close proximity to the boundary between the Arid West Supplement and the Western Mountains, Valleys, and Coast Region Supplement (slightly inside the Arid West Boundary). The Arid West Supplement was chosen for the delineation rather than the Western Mountains, Valleys, and Coast Region Supplement because the study area’s habitat and climatic conditions are more typical of San Francisco Bay Area conditions where the Arid West Supplement is used. As stated in the Arid West Supplement: “The decision to use the Western Mountains, Valleys, and Coast Regional Supplement or the Arid West Regional Supplement on a particular field site should be based on landscape and site conditions, and not solely on map location.”

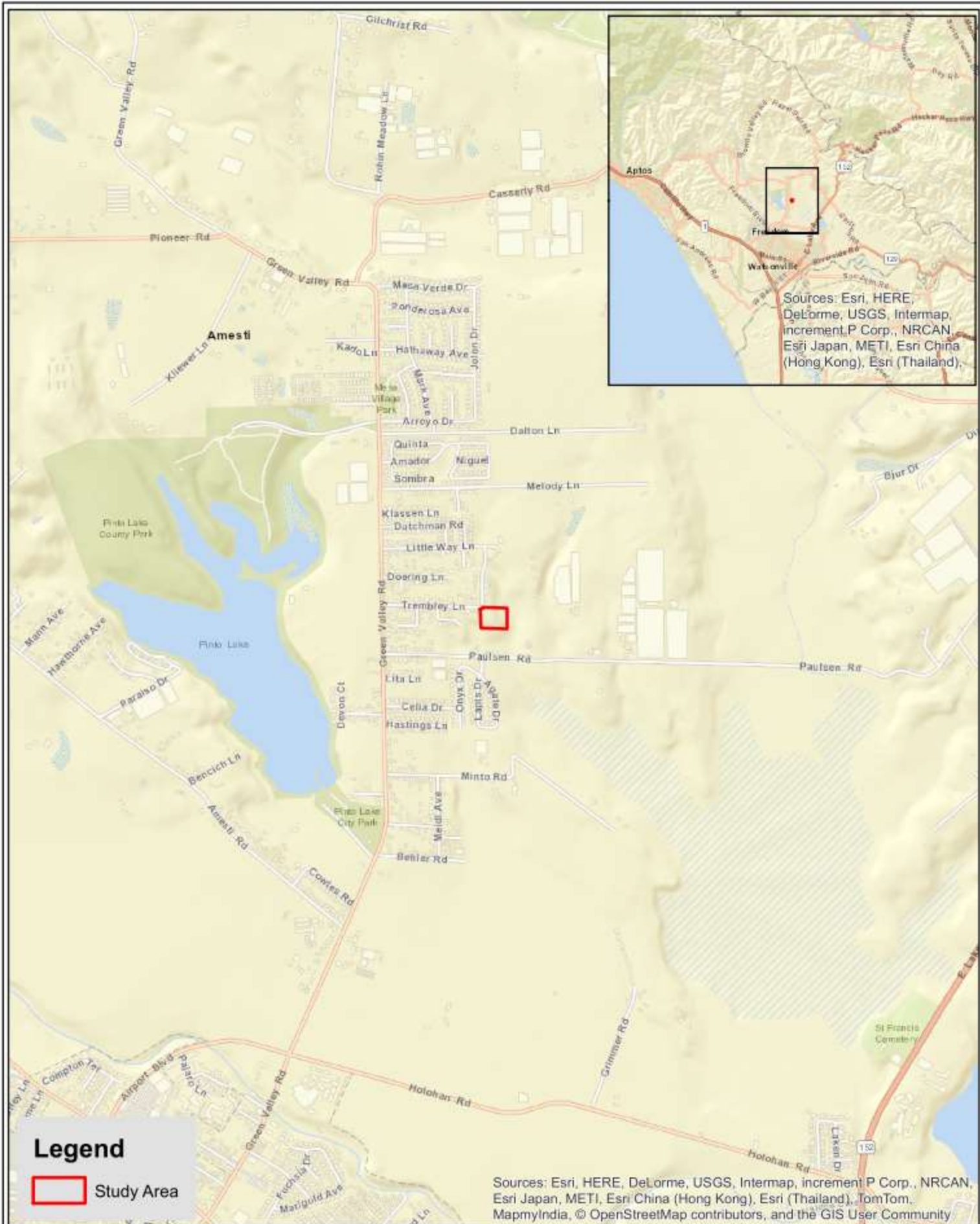

Figure 1. Study area locality map.

saturated soils of sufficient duration to exert a controlling influence on the plant species present” (Environmental Laboratory 1987). In order to determine if hydrophytic vegetation is present, each plant species occurring in a sample plot is identified and assigned a wetland indicator status (Table 1) based on the *National Wetland Plant List* (Lichvar et al. 2016).

Table 1. Wetland Plant Indicator Status.

Indicator Status Rating	Designation	Qualitative Description (Lichvar et al. 2016)
Obligate (OBL)	Hydrophyte	Almost always occur in wetlands
Facultative Wetland (FACW)	Hydrophyte	Usually occur in wetlands, but may occur in non-wetlands
Facultative (FAC)	Hydrophyte	Occur in wetlands and non-wetlands
Facultative Upland (FACU)	Nonhydrophyte	Usually occur in non-wetlands, but may occur in wetlands
Upland (UPL)	Nonhydrophyte	Almost never occur in wetlands

Plants that have an indicator status of OBL, FACW, and FAC are considered to be typically adapted for life in anaerobic soils conditions, and qualify as hydrophytic species for Section 404 delineations. If more than 50 percent of the dominant plant species present in a sample plot are classified as hydrophytic species (e.g., FAC or wetter), the area has met the hydrophytic vegetation criterion. Dominant species are selected using the “50/20 rule” (USACE 2008a).

2.2 Wetland Hydrology

Wetland hydrology “encompasses all hydrologic characteristics of areas that are periodically inundated or have soils saturated to the surface at some time during the growing season sufficient to create anaerobic and reducing conditions” (Environmental Laboratory 1987). The jurisdictional wetland hydrology criterion is satisfied if the area supports “14 or more consecutive days of flooding or ponding, or a water table 12 in. (30 cm) or less below the soil surface, during the growing season at a minimum frequency of 5 years in 10 (50 percent or higher probability)” (USACE 2008a). If recorded data—such as stream, tidal gauge, or hydrologic monitoring—are lacking, field indicators are used to determine the presence of wetland hydrology. Field indicators include primary indicators, such as observed inundation or saturation, biotic crust, and oxidized rhizospheres on living roots; or secondary indicators, such as drainage patterns and FAC-neutral test. The presence of one primary indicator, or two secondary indicators, is sufficient to conclude that an area has wetland hydrology (USACE 2008a).

2.3 Hydric Soils

Hydric soils are defined by the Natural Resources Conservation Service as “soils that formed under conditions of saturation, flooding, or ponding long enough during the growing season to develop anaerobic conditions in the upper part of the soil” (Federal Register 1994). Nearly all hydric soils exhibit characteristic morphologies that result from repeated periods of saturation or inundation, or both, for more than a few days. Characteristic hydric soil indicators observable in the field include: histic epipedons; sulfidic material; aquic or preaquic moisture regime; reducing conditions; iron and manganese concretions; and soil colors (gleyed soils, soils with mottles and/or low chroma matrix). Color designations are determined by comparing a soil sample with a standard Munsell soil color chart (Gretag Macbeth 2000). The presence of any one of the above listed field indicators is considered sufficient to meet the hydric soil criterion.

2.4 Other Waters of the U.S.

In addition to potential jurisdictional wetlands, this study evaluated the presence of any “waters of the U.S.” other than wetlands potentially subject to jurisdiction under Section 404 of the CWA. “Other waters” are seasonal or perennial water bodies, such as lakes, stream channels (including intermittent or ephemeral streams), drainages, ponds, and other surface water features that exhibit an Ordinary High Water Mark (OHWM) but lack positive indicators of one or more of the three wetland parameters (hydrophytic vegetation, wetland hydrology, hydric soils) (Federal Register 1986). In non-tidal “other waters,” Corps jurisdiction extends to the OHWM, defined as “that line on the shore established by the fluctuations of water and indicated by physical characteristics such as clear, natural line impressions on the bank, shelving, changes in the characteristics of the soil, destruction of terrestrial vegetation, the presence of litter and debris” (Federal Register 1986; USACE 2005; 2008b).

2.5 Limitations

The results of this delineation are preliminary and based on conditions observed during the field visit, and the wetland scientist’s interpretation of those conditions and Corps guidelines. All wetlands delineated on the study area in this report are “potential jurisdictional wetlands” until verified by applicable regulatory agencies. Plants that are dominant at the time of this delineation may shift in importance depending on rainfall conditions and season, or population shifts over time. Recent court decisions have added uncertainty to the jurisdictional determination process. The Corps makes the final determination (subject to administrative appeal and judicial review) about the location and extent of wetlands and other waters of the U.S. on the study area. This delineation report should be sent to the Corps for verification, and any required permits obtained, prior to any work conducted in jurisdictional waters. In addition, California state agencies such as the Regional Water Quality Control Board and California Department of Fish and Wildlife, as well as local agencies such as the County of Santa Cruz, may also have jurisdiction over wetlands and other waters on the study area, and permits and/or other approvals should be obtained from these agencies as needed.

3.0 STUDY AREA DESCRIPTION

The study area covers ~2.3-acres and includes the entire parcel located southeast of the intersection of Trembley Lane and Cunningham Way (APN 051-411-20) in unincorporated Watsonville, Santa Cruz County (Figure 1). The study area is currently undeveloped but impacted by human activity, including vehicle activity and minor grading, as well as a storage container and soil stockpiles in the central portion of the study area. Most of the study area is proposed for development, as shown on site plans, dated December 30, 2014, prepared by Roper Engineering. Surrounding land uses consist of agricultural land to the east, dense residential development to the west, and undeveloped or low-density residential land to the north and south.

3.1 Vegetation

Four habitats are present on the study area: Non-Native Grassland, Coast Live Oak Woodland, Willow Scrub, and Rush-Blackberry. A ruderal phase of Non-Native Grassland², composed of the *Avena* and other non-native herbaceous Alliances³, covers most of the study area and is dominated by non-native grasses and forbs adapted to disturbance, including slender wild oat (*Avena barbata*⁴), rigput brome

² Vegetation nomenclature follows Holland (1986).

³ Alliance nomenclature follows Sawyer et al. (2009).

⁴ Botanical nomenclature follows Baldwin et al. (2012) and The Jepson Flora Project (2018).

(*Bromus diandrus*), barley (*Hordeum murinum* subsp. *leporinum*), black mustard (*Brassica nigra*), vetch (*Vicia sativa*), hairy vetch (*Vicia villosa*), Italian thistle (*Carduus pycnocephalus*), bur clover (*Medicago polymorpha*), rescue grass (*Bromus catharticus*), rattail fescue (*Festuca myuros*), Italian ryegrass (*Festuca perennis*), sheep sorrel (*Rumex acetosella*), soft chess (*Bromus hordeaceus*), wild radish (*Raphanus sativus*), English plantain (*Plantago lanceolata*), and rough cat's-ear (*Hypochaeris radicata*), with occasional native species present including coyote brush (*Baccharis pilularis*) and California poppy (*Eschscholzia californica*). Coast Live Oak Woodland, composed of the *Quercus agrifolia* Woodland Alliance, occurs along the northern study area boundary and as small stands or isolated trees in the eastern portion of the study area. This habitat is dominated by a canopy of coast live oak (*Quercus agrifolia*), with an understory of poison oak (*Toxicodendron diversilobum*), California blackberry (*Rubus ursinus*), Bermuda buttercup (*Oxalis pes-caprae*), and herbaceous species characteristic of Non-Native Grassland described above.

Willow Scrub occurs in the northeastern corner of the study area in low-lying, generally concave topography that appears to collect surface and/or shallow subsurface water draining from upslope areas to the west. This habitat is dominated by willow (*Salix* sp.), with other hydrophytic (Lichvar et al. 2016) plant species present, including tall flatsedge (*Cyperus eragrostis*), spreading rush (*Juncus patens*), pennyroyal (*Mentha pulegium*), birds-foot trefoil (*Lotus corniculatus*), and rabbitsfoot grass (*Polygomon monspeliensis*). Rush-Blackberry consists of a potential seep area and adjacent man-made ditch dominated by spreading rush and Himalayan blackberry (*Rubus armeniacus*) in the southwestern portion of the study area. In addition, planted trees are present along the study area boundary, including several pine (*Pinus* sp.) trees along the southwestern study area boundary.

3.2 Geology, Climate, and Soils

The study area occurs between ~95 and 130-foot elevation (USGS 1954) (Figure 2) and is underlain by marine and continental sedimentary rocks (older alluvium, lake, playa, and terrace deposits) of Pleistocene age (California Geological Survey 2010). Average annual precipitation in the region is 21.52 inches, occurring primarily between October and May (Western Regional Climate Center 2018).

Two soil types have been mapped on the study area in the Web Soil Survey (NRCS 2018a):

- 163—Pinto loam, 9 to 15 percent slopes
- 177—Watsonville loam, 2 to 15 percent slopes

Pinto Series soils are classified as Fine-loamy, mixed, superactive, thermic Typic Argixerolls. Pinto loam, 9 to 15 percent slopes, is a moderately well-drained soil derived from alluvium and/or marine deposits and is typically found on alluvial fans and terraces. A typical profile consists of loam from 0 to 21 inches and sandy clay loam, clay loam, and/or loam from 21 to 51 inches. The depth to water table and a restrictive feature is >80 inches beneath the surface.

Watsonville Series soils are classified as Fine, smectitic, thermic Xeric Argialbolls. Watsonville loam, 2 to 15 percent slopes, is a somewhat poorly drained soil derived from alluvium and is typically found on marine terraces. A typical profile consists of loam from 0 to 18 inches and clay, clay loam, and/or sandy clay loam from 18 to 39 inches of soil profile. The depth to water table is >80 inches and the depth to a restrictive feature (abrupt textural change) is ~18 inches beneath the surface.

Both of these soils can be considered hydric soils for Santa Cruz County when found on marine terraces (NRCS 2018b). A soil map of the study area is included in Appendix B.

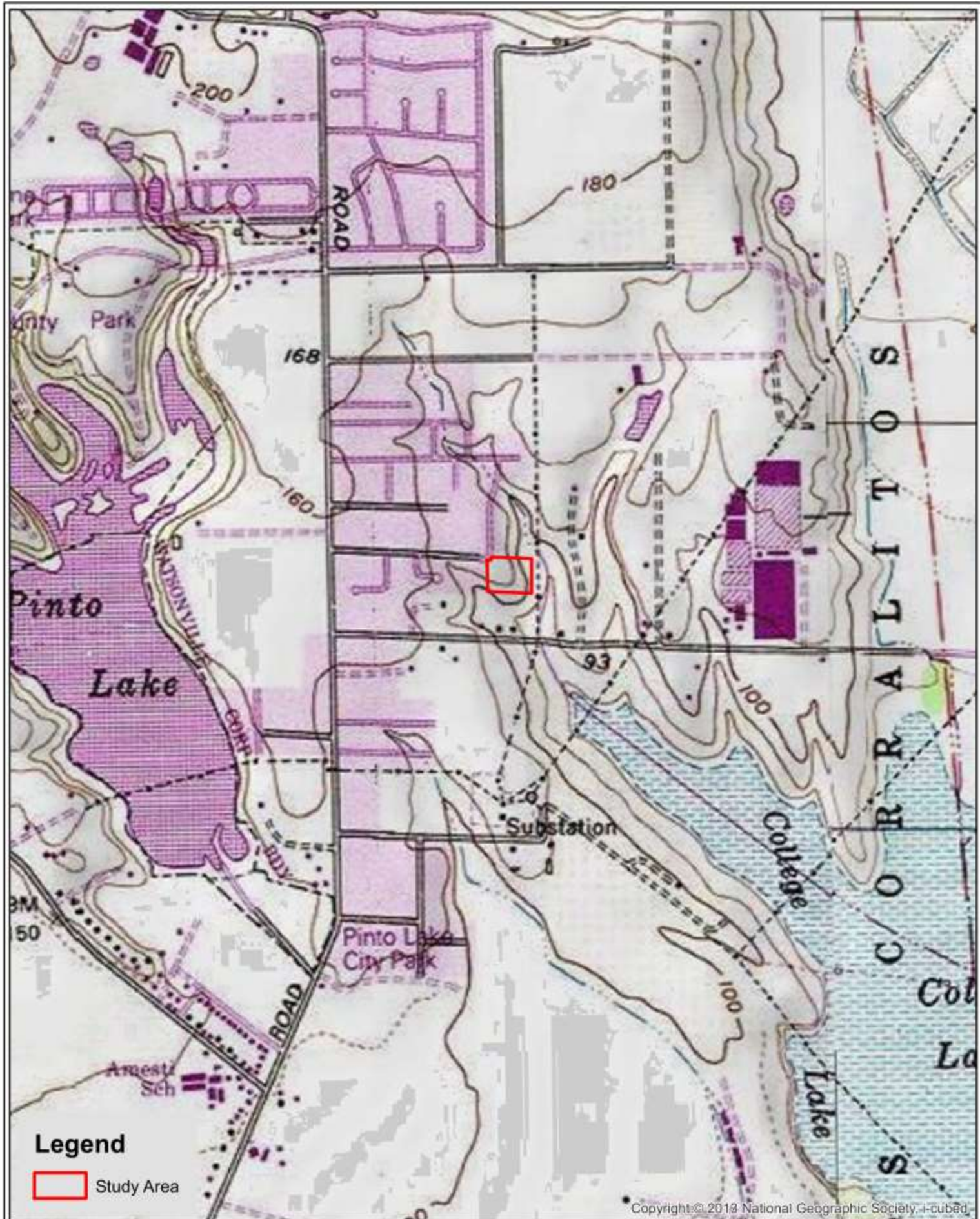

Copyright © 2013 National Geographic Society, i-cubed

Figure 2. Topographic map of the study area.

Basemap: USGS 7.5' Watsonville West, CA Quad
 Study Area: Mt. Diablo Meridian, T11S, R2E, sec21
 Lat/Lon: 36.956884°N, 121.759665°W

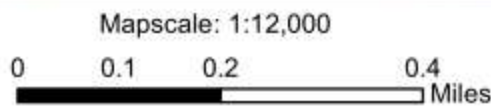

3.3 Hydrology

No streams or ponds have been mapped on the study area in the USGS Watsonville West 7.5' quad (USGS 1954) or in the National Hydrography Dataset (NHD) (USGS 2018), but an unnamed intermittent drainage channel (hereafter referred to as "creek") is located ~50 to 100-feet north and east of the study area. The creek flows southbound, east of the study area, and eventually to College Lake, Corralitos Creek, Salsipuedes Creek, and the Pajaro River, which discharges into the Monterey Bay, a Traditional Navigable Water (TNW). No wetlands have been mapped for the study area in the National Wetlands Inventory (NWI) (USFWS 2018), but the offsite creek was mapped as Riverine Wetland in the NWI (Figure 3).

The principal hydrologic sources for the study area are direct precipitation and surface sheet flow and shallow subsurface flow from surrounding uplands. The study area slopes toward the southeast and the offsite creek. Several narrow man-made ditches were observed on the study area which appear designed to facilitate drainage from the central portion of the study area toward the south and east. Water appears to drain off the study area toward the southeast via surface sheet flow, shallow subsurface flow, and the man-made ditches. A shallow aquitard (heavy clay layer) was observed 6 to 12 inches beneath the surface in several portions of the study area, which may perch water and contribute to surface and near-surface saturation. No concentrated hydrologic outlets from the study area were observed (such as a culvert inlet or channel connection to the offsite creek), but water likely collects in low areas along the eastern and southeastern study area boundary before discharging via sheet flow/near-surface flow into the creek and/or dissipating via infiltration and evapotranspiration.

4.0 RESULTS

4.1 Aquatic Resources

Two potential jurisdictional wetlands were delineated on the study area during the May 22, 2018 delineation. These features are discussed below, summarized in Table 2, and are shown on the map in Figure 4. Delineation datasheets are included in Appendix A, study area photographs are included in Appendix C, and a list of all plant species observed on the study area, and their wetland indicator status, is included in Appendix D.

Table 2. Aquatic Resources Delineated on the Study Area.

Feature Name	Area (ft ²)	Sample Point	Hydric Soils	Wetland Hydro	Hydrophytic Vegetation	Significant Nexus to TNW	Cowardin Class	Lat/Lon
Wetland 1	2,774	1a, 2a	X	X	X	Probable (drains off the study area potentially via sheet flow and/or near surface flow to offsite creek, which drains to the Monterey Bay, a TNW).	PEM1 ⁵	36.956754, -121.760015
Wetland 2	3,975	5a, 6a	X	X	X	Probable (drains off the study area potentially via sheet flow and/or near surface flow to offsite creek, which drains to the Monterey Bay, a TNW).	PEM1	36.957119, -121.759269

⁵ Palustrine Emergent, Persistent





Figure 3. National Wetlands Inventory map of the study area.

Data Source: NWI (USFWS 2018)
 Orthophoto Date: (7/23/16); Map Date: 5/23/18



Legend

-  Study Area
-  Potential Jurisdictional Wetlands
-  Sample Points

Source: Esri, DigitalGlobe, GeoEye, Earthstar Geographics, CNES/Airbus DS, USDA, USGS, AeroGRID, IGN, and the GIS User Community

Figure 4. Delineation map of the Lakeview Estates study area.

Study Area Lat/Lon: 36.956884°N, 121.759665°W
 Orthophoto Date: (7/23/16); Map Date: 5/23/18

Mapscale: 1:700

0 25 50 100 Feet



4.1.1 Potential Jurisdictional Wetlands

Wetland 1

Wetland 1 covers 2,774 ft² (0.06-acre) and occurs in the southwestern portion of the study area on sloped terrain that appears to receive surface and near-surface runoff from upslope (Table 2; Figure 4; Appendix C-1, C-3). Wetland 1 is dominated by hydrophytic vegetation, including spreading rush and Himalayan blackberry (Sample Points 1a, 2a). Hydric soil indicators are present throughout Wetland 1, such as Redox Dark Surface (F6), as well as wetland hydrology indicators, including Sediment Deposits (B2), Surface Soil Cracks (B6), Drainage Patterns (B10), and Shallow Aquitard (D5). The shallow aquitard (heavy clay layer) observed in this area may be perching water and contributing to wetland hydrology. Adjacent uplands occur on slopes above the wetland, and are dominated by upland species such as wild oats, riggut brome, and hairy vetch (Appendix C-2). These uplands lack wetland hydrology and hydric soil indicators (Sample Point 2b), or contain some hydric soil indicators, presumably due to the aforementioned shallow aquitard that perches water near the surface, but of insufficient duration to produce wetland hydrology (Sample Point 1b).

Wetland 1 was delineated to include both a seep area and a man-made drainage ditch that drains toward the southeast. Though containing positive indicators of the three wetland parameters, the ditch portion of Wetland 1 could potentially be excluded from Corps jurisdiction because it is a man-made ditch dug in uplands, though the Corps would need to make this determination. Other man-made ditches were observed on the study area, presumably dug to drain the central portion of the study area, but these ditches lacked an OHWM and did not support positive indicators from all three wetland parameters (Sample Points 3, 4; Appendix C-4), and therefore these ditches were not delineated as potential jurisdictional wetlands or other waters.

The ditch in Wetland 1 ends abruptly with no culvert or other obvious hydrologic outlet, but evidence of scour was observed below the ditch, so it potentially overtops the bank and drains toward the southeast (and potentially the offsite creek, which was not investigated because it is located on private property) during wet periods. The creek flows southbound, east of the study area, and eventually to College Lake, Corralitos Creek, Salsipuedes Creek, and the Pajaro River, which discharges into the Monterey Bay, a TNW.

Wetland 2

Wetland 2 covers 3,975 ft² (0.09-acre) and occurs in the eastern portion of the study area in a shallow swale at the toe of a slope (Table 2; Figure 4; Appendix C-5, C6). Wetland 2 is dominated by hydrophytic vegetation, including tall flatsedge, Italian ryegrass, pennyroyal, birds-foot trefoil, and rabbitsfoot grass (Sample Points 5a, 6a). In addition, though not included in the sample point data, much of the wetland is dominated by revegetating areas of willow, which were impacted by past ground disturbance. Based on a review of historic aerial photographs, much of this wetland was likely previously dominated by a dense willow canopy, and this may have been part of a broader historic Riparian Corridor along the offsite creek prior to development of the area (particularly agricultural development east of the study). Hydric soil indicators are present throughout Wetland 2, such as Redox Dark Surface (F6), as well as wetland hydrology indicators, including Sediment Deposits (B2), Drainage Patterns (B10), and Oxidized Rhizospheres along Living Roots (C3). Adjacent uplands occur on slopes above the swale, and are dominated by upland species such as Italian thistle, wild oats, and riggut brome, and lack wetland hydrology and hydric soil indicators (Sample Point 5b), or appear to be transitional areas lacking wetland hydrology and hydric soils, but likely receiving elevated soil moisture sufficient to support dense areas of California blackberry (Sample Point 6b).

Wetland 2 drains southbound along the eastern study area boundary. Though wetland indicators cease at the southern delineated wetland boundary (Figure 4), drainage likely continues as sheet flow through concave topography toward the southeastern study area boundary. No culverts, channels, or other obvious concentrated discharge areas were observed, but drainage likely continues off the study area toward the south and east as surface sheet flow and/or near-surface flow toward the offsite creek. The creek flows southbound, east of the study area, and eventually to Corralitos Creek, Salsipuedes Creek, and the Pajaro River, which discharges into the Monterey Bay, a TNW.

5.0 POTENTIAL CORPS JURISDICTION

Two potential jurisdictional wetlands were delineated on the study area during the May 22, 2018 delineation (Table 2; Figure 4). Though no direct, concentrated hydrologic connection (such as a culvert or channel) between the wetlands and the offsite creek was observed, they could be hydrologically connected via surface sheet flow and/or near-surface or subsurface flow. However, the creek is located on private property east of the study area, and therefore a more detailed investigation of hydrologic connections was not conducted. The Corps would need to make a determination on the jurisdictional status of both potential jurisdictional wetlands.

The proposed project on the study area consists of development of a nine-lot residential subdivision as shown on site plans, dated December 30, 2014, prepared by Roper Engineering. Discharge of dredged or fill material within Corps jurisdiction normally requires a permit under Section 404 of the federal CWA. In addition, the Corps, under Section 401 of the federal CWA, is required to meet state water quality regulations prior to granting a Section 404 permit. This is accomplished by application to the local Regional Water Quality Control Board (RWQCB) for Section 401 certification (or waiver) that requirements have been met. In addition, the RWQCB could have jurisdiction over “isolated” or other wetlands exempt from Corps jurisdiction under the Porter-Cologne Water Quality Control Act. Streams, rivers, and lakes up to the top of bank or dripline of riparian vegetation (whichever is greater) also fall within the jurisdiction of the California Department of Fish and Wildlife (CDFW). If work is proposed within Willow Scrub habitat in Wetland 2, the CDFW should be contacted to determine if this is considered remnant riparian vegetation for the offsite creek, and if a Streambed Alteration Agreement is required. In addition, the Santa Cruz County Code contains setbacks and other requirements related to wetlands.

6.0 REFERENCES

- Baldwin, B.G., D.H. Goldman, D.J. Keil, R. Patterson, T.J. Rosatti, and D.H. Wilken, editors. 2012. *The Jepson manual: vascular plants of California*, second edition. University of California Press, Berkeley.
- California Geological Survey. 2010. Geologic map of California. Accessed at http://www.conservation.ca.gov/cgs/cgs_history/Pages/2010_geologicmap.aspx.
- Environmental Laboratory. 1987. Corps of Engineers wetlands delineation manual. Technical report Y-87-1, U.S. Army Corps of Engineers Waterways Experiment Station, Vicksburg, Mississippi.
- Federal Register. 1980. Environmental Protection Agency, 40 CFR Part 230: Section 404(b)(1) guidelines for specification of disposal sites for dredged or fill material.

- Federal Register. 1982. Department of the Army, Corps of Engineers, Title 33: Navigation and navigable waters; Chapter 2. Regulatory program, Corps of Engineers.
- Federal Register. 1986. Department of the Army, Corps of Engineers, 33 CFR Parts 320 through 330, Regulatory Programs of the Corps of Engineers; Final Rule. Vol. 51, No. 219; page 41217, November 13.
- Federal Register. 1994. Changes in hydric soils of the United States. Washington, DC, July 13.
- Gretag Macbeth. 2000. Munsell soil color charts. New Windsor, New York.
- Holland, R.F. 1986. Preliminary descriptions of the terrestrial natural communities of California. California Department of Fish and Game, Sacramento, CA.
- Jepson Flora Project (eds.) 2018. Jepson eFlora, <http://ucjeps.berkeley.edu/eflora/>.
- Lichvar, R.W., D.L. Banks, W.N. Kirchner, and N.C. Melvin. 2016. *The National Wetland Plant List: 2016 wetland ratings*. Phytoneuron 2016-30: 1-17. Published 28 April 2016.
- Natural Resource Conservation Service. 2018a. Web Soil Survey. Accessed at: <http://websoilsurvey.nrcs.usda.gov/app/WebSoilSurvey.aspx>.
- _____. 2018b. Lists of hydric soils. Accessed at: <https://www.nrcs.usda.gov/wps/portal/nrcs/main/soils/use/hydric/>
- Sawyer, J.O., T. Keeler-Wolf, and J.M. Evans. 2009. A manual of California vegetation, second edition. California Native Plant Society. Sacramento, CA.
- U.S. Army Corps of Engineers. 2005. Regulatory guidance letter 05-05: Ordinary high water mark identification. Dated December 7.
- _____. 2008a. Regional Supplement to the Corps of Engineers Wetland Delineation Manual: Arid West Region (Version 2.0), ed. J. S. Wakeley, R. W. Lichvar, and C. V. Noble. ERDC/EL TR-08-28. Vicksburg, MS: U.S. Army Engineer Research and Development Center.
- _____. 2008b. A field guide to the identification of the ordinary high water mark (OHWM) in the Arid West Region of the Western United States. Dated August.
- U.S. Fish and Wildlife Service. 2018. National Wetlands Inventory. Accessed at <http://www.fws.gov/wetlands>.
- U. S. Geological Survey. 1954. Watsonville West, Calif. 7.5 minute topographic quadrangle. Photorevised 1980.
- _____. 2018. National hydrography dataset. Accessed at <https://nhd.usgs.gov/>.
- Western Regional Climate Center. 2018. 1908-2016 monthly climate summary for Watsonville Water Works, California (049473). Accessed at <http://www.wrcc.dri.edu>.

CORPS DELINEATION DATA FORMS

WETLAND DETERMINATION DATA FORM – Arid West Region

Project/Site: Lakeview Estates (APN 051-411-20) City/County: Watsonville, Santa Cruz Co. Sampling Date: 5/22/18
 Applicant/Owner: Raeid Farhat State: CA Sampling Point: 1a
 Investigator(s): T. Mahony, Coast Range Biological LLC Section, Township, Range: Mt. Diablo Meridian, T11S,R2E,sec21
 Landform (hillslope, terrace, etc.): slope Local relief (concave, convex, none): concave Slope (%): 10
 Subregion (LRR): Mediterranean CA (LRR C) Lat: 36.956802 Long: -121.759925 Datum: NAD 83
 Soil Map Unit Name: Pinto loam, 9 to 15 percent slopes NWI classification: None

Are climatic / hydrologic conditions on the site typical for this time of year? Yes No (If no, explain in Remarks.)
 Are Vegetation , Soil , or Hydrology significantly disturbed? Are "Normal Circumstances" present? Yes No
 Are Vegetation , Soil , or Hydrology naturally problematic? (If needed, explain any answers in Remarks.)

SUMMARY OF FINDINGS – Attach site map showing sampling point locations, transects, important features, etc.

Hydrophytic Vegetation Present? Yes <input checked="" type="checkbox"/> No <input type="checkbox"/> Hydric Soil Present? Yes <input checked="" type="checkbox"/> No <input type="checkbox"/> Wetland Hydrology Present? Yes <input checked="" type="checkbox"/> No <input type="checkbox"/>	Is the Sampled Area within a Wetland? Yes <input checked="" type="checkbox"/> No <input type="checkbox"/>
Remarks: Seasonal hydrology naturally problematic. Located in sloped area that likely receives surface and near-surface water from upslope. Drains into man-made ditch. All three wetland parameters met. Potential jurisdictional wetland.	

VEGETATION – Use scientific names of plants.

Tree Stratum (Plot size: <u>10'</u>)	Absolute % Cover	Dominant Species?	Indicator Status	
1. _____				Dominance Test worksheet: Number of Dominant Species That Are OBL, FACW, or FAC: <u>1</u> (A) Total Number of Dominant Species Across All Strata: <u>1</u> (B) Percent of Dominant Species That Are OBL, FACW, or FAC: <u>100</u> (A/B)
2. _____				
3. _____				
4. _____				
_____ = Total Cover				Prevalence Index worksheet: Total % Cover of: _____ Multiply by: _____ OBL species _____ x 1 = _____ FACW species _____ x 2 = _____ FAC species _____ x 3 = _____ FACU species _____ x 4 = _____ UPL species _____ x 5 = _____ Column Totals: _____ (A) _____ (B) Prevalence Index = B/A = _____
Sapling/Shrub Stratum (Plot size: <u>5'</u>) 1. _____ 2. _____ 3. _____ 4. _____ 5. _____ _____ = Total Cover				
Herb Stratum (Plot size: <u>5'</u>) 1. <u>Juncus patens</u> 70 Y FACW 2. <u>Phalaris aquatica</u> 10 N FACU 3. <u>Vicia villosa</u> 5 N UPL 4. <u>Festuca perennis</u> 5 N FAC 5. <u>Avena barbata</u> 5 N UPL 6. <u>Lysimachia arvensis</u> 2 N FAC 7. <u>Bromus diandrus</u> 1 N UPL 8. _____ _____ = Total Cover				
Woody Vine Stratum (Plot size: <u>5'</u>) 1. _____ 2. _____ _____ = Total Cover				
% Bare Ground in Herb Stratum <u>5</u> % Cover of Biotic Crust _____				
Remarks: Sample point dominated by hydrophytic vegetation.				

SOIL

Sampling Point: 1a

Profile Description: (Describe to the depth needed to document the indicator or confirm the absence of indicators.)

Depth (inches)	Matrix		Redox Features				Texture	Remarks
	Color (moist)	%	Color (moist)	%	Type ¹	Loc ²		
0-6	10YR 3/2	95	10YR 4/6	5	C	M/PL	clay	
6-20	10YR 3/1	80	10YR 5/6	20	C	M/PL	clay	heavy clay

¹Type: C=Concentration, D=Depletion, RM=Reduced Matrix, CS=Covered or Coated Sand Grains. ²Location: PL=Pore Lining, M=Matrix.

Hydric Soil Indicators: (Applicable to all LRRs, unless otherwise noted.)

- Histosol (A1)
- Histic Epipedon (A2)
- Black Histic (A3)
- Hydrogen Sulfide (A4)
- Stratified Layers (A5) (LRR C)
- 1 cm Muck (A9) (LRR D)
- Depleted Below Dark Surface (A11)
- Thick Dark Surface (A12)
- Sandy Mucky Mineral (S1)
- Sandy Gleyed Matrix (S4)

- Sandy Redox (S5)
- Stripped Matrix (S6)
- Loamy Mucky Mineral (F1)
- Loamy Gleyed Matrix (F2)
- Depleted Matrix (F3)
- Redox Dark Surface (F6)
- Depleted Dark Surface (F7)
- Redox Depressions (F8)
- ~~Vernal Pools (F9)~~

Indicators for Problematic Hydric Soils³:

- 1 cm Muck (A9) (LRR C)
- 2 cm Muck (A10) (LRR B)
- Reduced Vertic (F18)
- Red Parent Material (TF2)
- Other (Explain in Remarks)

³Indicators of hydrophytic vegetation and wetland hydrology must be present, unless disturbed or problematic.

Restrictive Layer (if present):

Type: heavy clay
 Depth (inches): 6"

Hydric Soil Present? Yes No

Remarks:

Hydric soil indicators observed.

HYDROLOGY

Wetland Hydrology Indicators:

Primary Indicators (minimum of one required; check all that apply)

- Surface Water (A1)
- High Water Table (A2)
- Saturation (A3)
- Water Marks (B1) (Nonriverine)
- Sediment Deposits (B2) (Nonriverine)
- Drift Deposits (B3) (Nonriverine)
- Surface Soil Cracks (B6)
- Inundation Visible on Aerial Imagery (B7)
- Water-Stained Leaves (B9)

- Salt Crust (B11)
- Biotic Crust (B12)
- Aquatic Invertebrates (B13)
- Hydrogen Sulfide Odor (C1)
- Oxidized Rhizospheres along Living Roots (C3)
- Presence of Reduced Iron (C4)
- Recent Iron Reduction in Tilled Soils (C6)
- Thin Muck Surface (C7)
- Other (Explain in Remarks)

Secondary Indicators (2 or more required)

- Water Marks (B1) (Riverine)
- Sediment Deposits (B2) (Riverine)
- Drift Deposits (B3) (Riverine)
- Drainage Patterns (B10)
- Dry-Season Water Table (C2)
- Crayfish Burrows (C8)
- Saturation Visible on Aerial Imagery (C9)
- Shallow Aquitard (D3)
- FAC-Neutral Test (D5)

Field Observations:

Surface Water Present? Yes No Depth (inches): None
 Water Table Present? Yes No Depth (inches): None
 Saturation Present? (includes capillary fringe) Yes No Depth (inches): None

Wetland Hydrology Present? Yes No

Describe Recorded Data (stream gauge, monitoring well, aerial photos, previous inspections), if available:

None

Remarks:

Located in sloping depression that appears to receive surface and near-surface runoff from upslope. Shallow layer (~6 inches depth) of heavy clay likely perches water and contributes to surface and near-surface wetland hydrology. Drains toward the southeast via sheet flow, as well as into a man-made drainage ditch. Ditch ends abruptly, with no culvert or other outlet, but likely overtops during rainy season (based on evidence of scour below ditch) and drains via sheet flow toward southeast, off study area, and potentially into offsite creek.

WETLAND DETERMINATION DATA FORM – Arid West Region

Project/Site: Lakeview Estates (APN 051-411-20) City/County: Watsonville, Santa Cruz Co. Sampling Date: 5/22/18
 Applicant/Owner: Raeid Farhat State: CA Sampling Point: 1b
 Investigator(s): T. Mahony, Coast Range Biological LLC Section, Township, Range: Mt. Diablo Meridian, T11S,R2E,sec21
 Landform (hillslope, terrace, etc.): slope Local relief (concave, convex, none): convex Slope (%): 10
 Subregion (LRR): Mediterranean CA (LRR C) Lat: 36.956833 Long: -121.759976 Datum: NAD 83
 Soil Map Unit Name: Pinto loam, 9 to 15 percent slopes NWI classification: None

Are climatic / hydrologic conditions on the site typical for this time of year? Yes No (If no, explain in Remarks.)
 Are Vegetation , Soil , or Hydrology significantly disturbed? Are "Normal Circumstances" present? Yes No
 Are Vegetation , Soil , or Hydrology naturally problematic? (If needed, explain any answers in Remarks.)

SUMMARY OF FINDINGS – Attach site map showing sampling point locations, transects, important features, etc.

Hydrophytic Vegetation Present? Yes <input type="checkbox"/> No <input checked="" type="checkbox"/> Hydric Soil Present? Yes <input checked="" type="checkbox"/> No <input type="checkbox"/> Wetland Hydrology Present? Yes <input type="checkbox"/> No <input checked="" type="checkbox"/>	Is the Sampled Area within a Wetland? Yes <input type="checkbox"/> No <input checked="" type="checkbox"/>
Remarks: Seasonal hydrology naturally problematic. Hydric soil indicators present (likely due to heavy clay) but strongly upland vegetation present and wetland hydrology absent. Sample point located in upland.	

VEGETATION – Use scientific names of plants.

Tree Stratum (Plot size: <u>10'</u>)	Absolute % Cover	Dominant Species?	Indicator Status	
1. _____	_____	_____	_____	
2. _____	_____	_____	_____	
3. _____	_____	_____	_____	
4. _____	_____	_____	_____	
_____ = Total Cover				
Sapling/Shrub Stratum (Plot size: <u>5'</u>)	Absolute % Cover	Dominant Species?	Indicator Status	
1. _____	_____	_____	_____	
2. _____	_____	_____	_____	
3. _____	_____	_____	_____	
4. _____	_____	_____	_____	
5. _____	_____	_____	_____	
_____ = Total Cover				
Herb Stratum (Plot size: <u>5'</u>)	Absolute % Cover	Dominant Species?	Indicator Status	
1. <u>Avena barbata</u>	<u>60</u>	<u>Y</u>	<u>UPL</u>	
2. <u>Bromus diandrus</u>	<u>10</u>	<u>N</u>	<u>UPL</u>	
3. <u>Vicia villosa</u>	<u>10</u>	<u>N</u>	<u>UPL</u>	
4. <u>Festuca perennis</u>	<u>10</u>	<u>N</u>	<u>FAC</u>	
5. <u>Convolvulus arvensis</u>	<u>5</u>	<u>N</u>	<u>UPL</u>	
6. _____	_____	_____	_____	
7. _____	_____	_____	_____	
8. _____	_____	_____	_____	
_____ = Total Cover				
Woody Vine Stratum (Plot size: <u>5'</u>)	Absolute % Cover	Dominant Species?	Indicator Status	
1. _____	_____	_____	_____	
2. _____	_____	_____	_____	
_____ = Total Cover				
% Bare Ground in Herb Stratum <u>5</u> % Cover of Biotic Crust _____				

Dominance Test worksheet:
 Number of Dominant Species That Are OBL, FACW, or FAC: 0 (A)
 Total Number of Dominant Species Across All Strata: 1 (B)
 Percent of Dominant Species That Are OBL, FACW, or FAC: 0 (A/B)

Prevalence Index worksheet:
 Total % Cover of: _____ Multiply by: _____
 OBL species _____ x 1 = _____
 FACW species _____ x 2 = _____
 FAC species 10 x 3 = 30
 FACU species _____ x 4 = _____
 UPL species 85 x 5 = 425
 Column Totals: 95 (A) 455 (B)
 Prevalence Index = B/A = 4.79

Hydrophytic Vegetation Indicators:
 ___ Dominance Test is >50%
 ___ Prevalence Index is ≤3.0¹
 ___ Morphological Adaptations¹ (Provide supporting data in Remarks or on a separate sheet)
 ___ Problematic Hydrophytic Vegetation¹ (Explain)

¹Indicators of hydric soil and wetland hydrology must be present, unless disturbed or problematic.

Hydrophytic Vegetation Present? Yes No

Remarks:
 Sample point dominated by upland vegetation.

SOIL

Sampling Point: 1b

Profile Description: (Describe to the depth needed to document the indicator or confirm the absence of indicators.)

Depth (inches)	Matrix		Redox Features				Texture	Remarks
	Color (moist)	%	Color (moist)	%	Type ¹	Loc ²		
0-6	10YR 3/1	100	none				clay loam	
6-20	10YR 3/2	75	10YR 5/4	25	C	M/PL	clay	heavy clay

¹Type: C=Concentration, D=Depletion, RM=Reduced Matrix, CS=Covered or Coated Sand Grains. ²Location: PL=Pore Lining, M=Matrix.

Hydric Soil Indicators: (Applicable to all LRRs, unless otherwise noted.)

- Histosol (A1)
- Histic Epipedon (A2)
- Black Histic (A3)
- Hydrogen Sulfide (A4)
- Stratified Layers (A5) (LRR C)
- 1 cm Muck (A9) (LRR D)
- Depleted Below Dark Surface (A11)
- Thick Dark Surface (A12)
- Sandy Mucky Mineral (S1)
- Sandy Gleyed Matrix (S4)

- Sandy Redox (S5)
- Stripped Matrix (S6)
- Loamy Mucky Mineral (F1)
- Loamy Gleyed Matrix (F2)
- Depleted Matrix (F3)
- Redox Dark Surface (F6)
- Depleted Dark Surface (F7)
- Redox Depressions (F8)
- ~~Vernal Pools (F9)~~

Indicators for Problematic Hydric Soils³:

- 1 cm Muck (A9) (LRR C)
- 2 cm Muck (A10) (LRR B)
- Reduced Vertic (F18)
- Red Parent Material (TF2)
- Other (Explain in Remarks)

³Indicators of hydrophytic vegetation and wetland hydrology must be present, unless disturbed or problematic.

Restrictive Layer (if present):

Type: heavy clay
 Depth (inches): 6"

Hydric Soil Present? Yes No

Remarks:

Hydric soil indicators in subsoil.

HYDROLOGY

Wetland Hydrology Indicators:

Primary Indicators (minimum of one required; check all that apply)

- Surface Water (A1)
- High Water Table (A2)
- Saturation (A3)
- Water Marks (B1) (Nonriverine)
- Sediment Deposits (B2) (Nonriverine)
- Drift Deposits (B3) (Nonriverine)
- Surface Soil Cracks (B6)
- Inundation Visible on Aerial Imagery (B7)
- Water-Stained Leaves (B9)

- Salt Crust (B11)
- Biotic Crust (B12)
- Aquatic Invertebrates (B13)
- Hydrogen Sulfide Odor (C1)
- Oxidized Rhizospheres along Living Roots (C3)
- Presence of Reduced Iron (C4)
- Recent Iron Reduction in Tilled Soils (C6)
- Thin Muck Surface (C7)
- Other (Explain in Remarks)

Secondary Indicators (2 or more required)

- Water Marks (B1) (Riverine)
- Sediment Deposits (B2) (Riverine)
- Drift Deposits (B3) (Riverine)
- Drainage Patterns (B10)
- Dry-Season Water Table (C2)
- Crayfish Burrows (C8)
- Saturation Visible on Aerial Imagery (C9)
- Shallow Aquitard (D3)
- FAC-Neutral Test (D5)

Field Observations:

Surface Water Present? Yes No Depth (inches): None
 Water Table Present? Yes No Depth (inches): None
 Saturation Present? (includes capillary fringe) Yes No Depth (inches): None

Wetland Hydrology Present? Yes No

Describe Recorded Data (stream gauge, monitoring well, aerial photos, previous inspections), if available:

None

Remarks:

One structural secondary hydrology indicator present, but no evidence of wetland hydrology at or near the surface. Appears to be upslope of area where sufficient surface and/or near-surface water perches sufficient to create wetland hydrology.

WETLAND DETERMINATION DATA FORM – Arid West Region

Project/Site: Lakeview Estates (APN 051-411-20) City/County: Watsonville, Santa Cruz Co. Sampling Date: 5/22/18
 Applicant/Owner: Raeid Farhat State: CA Sampling Point: 2a
 Investigator(s): T. Mahony, Coast Range Biological LLC Section, Township, Range: Mt. Diablo Meridian, T11S,R2E,sec21
 Landform (hillslope, terrace, etc.): gentle slope Local relief (concave, convex, none): none Slope (%): 5
 Subregion (LRR): Mediterranean CA (LRR C) Lat: 36.956799 Long: -121.760111 Datum: NAD 83
 Soil Map Unit Name: Pinto loam, 9 to 15 percent slopes NWI classification: None

Are climatic / hydrologic conditions on the site typical for this time of year? Yes No (If no, explain in Remarks.)
 Are Vegetation , Soil , or Hydrology significantly disturbed? Are "Normal Circumstances" present? Yes No
 Are Vegetation , Soil , or Hydrology naturally problematic? (If needed, explain any answers in Remarks.)

SUMMARY OF FINDINGS – Attach site map showing sampling point locations, transects, important features, etc.

Hydrophytic Vegetation Present? Yes <input checked="" type="checkbox"/> No <input type="checkbox"/> Hydric Soil Present? Yes <input checked="" type="checkbox"/> No <input type="checkbox"/> Wetland Hydrology Present? Yes <input checked="" type="checkbox"/> No <input type="checkbox"/>	Is the Sampled Area within a Wetland? Yes <input checked="" type="checkbox"/> No <input type="checkbox"/>
Remarks: Seasonal hydrology naturally problematic. Located in sloped area that likely receives surface and near-surface water from upslope. Drains into man-made ditch. All three wetland parameters met. Potential jurisdictional wetland.	

VEGETATION – Use scientific names of plants.

Tree Stratum (Plot size: <u>10'</u>)	Absolute % Cover	Dominant Species?	Indicator Status	Dominance Test worksheet:
1. _____	_____	_____	_____	Number of Dominant Species That Are OBL, FACW, or FAC: <u>1</u> (A)
2. _____	_____	_____	_____	Total Number of Dominant Species Across All Strata: <u>1</u> (B)
3. _____	_____	_____	_____	Percent of Dominant Species That Are OBL, FACW, or FAC: <u>100</u> (A/B)
4. _____	_____	_____	_____	
= Total Cover				
Sapling/Shrub Stratum (Plot size: <u>5'</u>)	Absolute % Cover	Dominant Species?	Indicator Status	Prevalence Index worksheet:
1. <u>Rubus armeniacus</u>	<u>80</u>	<u>Y</u>	<u>FAC</u>	Total % Cover of: _____ Multiply by: _____
2. _____	_____	_____	_____	OBL species _____ x 1 = _____
3. _____	_____	_____	_____	FACW species _____ x 2 = _____
4. _____	_____	_____	_____	FAC species _____ x 3 = _____
5. _____	_____	_____	_____	FACU species _____ x 4 = _____
<u>80</u> = Total Cover				UPL species _____ x 5 = _____
				Column Totals: _____ (A) _____ (B)
				Prevalence Index = B/A = _____
Herb Stratum (Plot size: <u>5'</u>)	Absolute % Cover	Dominant Species?	Indicator Status	Hydrophytic Vegetation Indicators:
1. <u>Festuca perennis</u>	<u>2</u>	<u>N</u>	<u>FAC</u>	<input checked="" type="checkbox"/> Dominance Test is >50%
2. <u>Bromus diandrus</u>	<u>2</u>	<u>N</u>	<u>UPL</u>	<input type="checkbox"/> Prevalence Index is ≤3.0 ¹
3. _____	_____	_____	_____	<input type="checkbox"/> Morphological Adaptations ¹ (Provide supporting data in Remarks or on a separate sheet)
4. _____	_____	_____	_____	<input type="checkbox"/> Problematic Hydrophytic Vegetation ¹ (Explain)
5. _____	_____	_____	_____	
6. _____	_____	_____	_____	
7. _____	_____	_____	_____	
8. _____	_____	_____	_____	
<u>4</u> = Total Cover				
Woody Vine Stratum (Plot size: <u>5'</u>)	Absolute % Cover	Dominant Species?	Indicator Status	Hydrophytic Vegetation Present?
1. _____	_____	_____	_____	Yes <input checked="" type="checkbox"/> No <input type="checkbox"/>
2. _____	_____	_____	_____	
= Total Cover				
% Bare Ground in Herb Stratum <u>20</u> % Cover of Biotic Crust _____				

Remarks:
 Sample point dominated by hydrophytic vegetation.

SOIL

Sampling Point: 2a

Profile Description: (Describe to the depth needed to document the indicator or confirm the absence of indicators.)

Depth (inches)	Matrix		Redox Features				Texture	Remarks
	Color (moist)	%	Color (moist)	%	Type ¹	Loc ²		
0-5	10YR 2/2	95	10YR 5/6	5	C	M/PL	clay loam	
5-16	10YR 2/2	95	10YR 5/4	5	C	M/PL	clay	heavy clay

¹Type: C=Concentration, D=Depletion, RM=Reduced Matrix, CS=Covered or Coated Sand Grains. ²Location: PL=Pore Lining, M=Matrix.

Hydric Soil Indicators: (Applicable to all LRRs, unless otherwise noted.)

- Histosol (A1)
- Histic Epipedon (A2)
- Black Histic (A3)
- Hydrogen Sulfide (A4)
- Stratified Layers (A5) (LRR C)
- 1 cm Muck (A9) (LRR D)
- Depleted Below Dark Surface (A11)
- Thick Dark Surface (A12)
- Sandy Mucky Mineral (S1)
- Sandy Gleyed Matrix (S4)

- Sandy Redox (S5)
- Stripped Matrix (S6)
- Loamy Mucky Mineral (F1)
- Loamy Gleyed Matrix (F2)
- Depleted Matrix (F3)
- Redox Dark Surface (F6)
- Depleted Dark Surface (F7)
- Redox Depressions (F8)
- ~~Vernal Pools (F9)~~

Indicators for Problematic Hydric Soils³:

- 1 cm Muck (A9) (LRR C)
- 2 cm Muck (A10) (LRR B)
- Reduced Vertic (F18)
- Red Parent Material (TF2)
- Other (Explain in Remarks)

³Indicators of hydrophytic vegetation and wetland hydrology must be present, unless disturbed or problematic.

Restrictive Layer (if present):

Type: heavy clay
 Depth (inches): 5"

Hydric Soil Present? Yes No

Remarks:

Hydric soil indicators observed.

HYDROLOGY

Wetland Hydrology Indicators:

Primary Indicators (minimum of one required; check all that apply)

- Surface Water (A1)
- High Water Table (A2)
- Saturation (A3)
- Water Marks (B1) (Nonriverine)
- Sediment Deposits (B2) (Nonriverine)
- Drift Deposits (B3) (Nonriverine)
- Surface Soil Cracks (B6)
- Inundation Visible on Aerial Imagery (B7)
- Water-Stained Leaves (B9)

- Salt Crust (B11)
- Biotic Crust (B12)
- Aquatic Invertebrates (B13)
- Hydrogen Sulfide Odor (C1)
- Oxidized Rhizospheres along Living Roots (C3)
- Presence of Reduced Iron (C4)
- Recent Iron Reduction in Tilled Soils (C6)
- Thin Muck Surface (C7)
- Other (Explain in Remarks)

Secondary Indicators (2 or more required)

- Water Marks (B1) (Riverine)
- Sediment Deposits (B2) (Riverine)
- Drift Deposits (B3) (Riverine)
- Drainage Patterns (B10)
- Dry-Season Water Table (C2)
- Crayfish Burrows (C8)
- Saturation Visible on Aerial Imagery (C9)
- Shallow Aquitard (D3)
- FAC-Neutral Test (D5)

Field Observations:

Surface Water Present? Yes No Depth (inches): None
 Water Table Present? Yes No Depth (inches): None
 Saturation Present? (includes capillary fringe) Yes No Depth (inches): None

Wetland Hydrology Present? Yes No

Describe Recorded Data (stream gauge, monitoring well, aerial photos, previous inspections), if available:

None

Remarks:

Located in sloping depression that appears to receive surface and near-surface runoff from upslope. Shallow layer (~6 inches depth) of heavy clay likely perches water and contributes to surface and near-surface wetland hydrology. Drains toward the southeast via sheet flow, as well as into a man-made drainage ditch. Ditch ends abruptly, with no culvert or other outlet, but likely overtops during rainy season (based on evidence of scour below ditch) and drains via sheet flow toward southeast, off study area, and potentially into offsite creek.

WETLAND DETERMINATION DATA FORM – Arid West Region

Project/Site: Lakeview Estates (APN 051-411-20) City/County: Watsonville, Santa Cruz Co. Sampling Date: 5/22/18
 Applicant/Owner: Raeid Farhat State: CA Sampling Point: 2b
 Investigator(s): T. Mahony, Coast Range Biological LLC Section, Township, Range: Mt. Diablo Meridian, T11S,R2E,sec21
 Landform (hillslope, terrace, etc.): slope Local relief (concave, convex, none): convex Slope (%): 5
 Subregion (LRR): Mediterranean CA (LRR C) Lat: 36.956817 Long: -121.760138 Datum: NAD 83
 Soil Map Unit Name: Pinto loam, 9 to 15 percent slopes NWI classification: None

Are climatic / hydrologic conditions on the site typical for this time of year? Yes No (If no, explain in Remarks.)
 Are Vegetation , Soil , or Hydrology significantly disturbed? Are "Normal Circumstances" present? Yes No
 Are Vegetation , Soil , or Hydrology naturally problematic? (If needed, explain any answers in Remarks.)

SUMMARY OF FINDINGS – Attach site map showing sampling point locations, transects, important features, etc.

Hydrophytic Vegetation Present? Yes <input type="checkbox"/> No <input checked="" type="checkbox"/> Hydric Soil Present? Yes <input type="checkbox"/> No <input checked="" type="checkbox"/> Wetland Hydrology Present? Yes <input type="checkbox"/> No <input checked="" type="checkbox"/>	Is the Sampled Area within a Wetland? Yes <input type="checkbox"/> No <input checked="" type="checkbox"/>
Remarks: Seasonal hydrology naturally problematic. No wetland indicators observed. Sample point located in upland.	

VEGETATION – Use scientific names of plants.

Tree Stratum (Plot size: <u>10'</u>)	Absolute % Cover	Dominant Species?	Indicator Status	Dominance Test worksheet:
1. _____	_____	_____	_____	Number of Dominant Species That Are OBL, FACW, or FAC: <u>0</u> (A)
2. _____	_____	_____	_____	Total Number of Dominant Species Across All Strata: <u>3</u> (B)
3. _____	_____	_____	_____	Percent of Dominant Species That Are OBL, FACW, or FAC: <u>0</u> (A/B)
4. _____	_____	_____	_____	
_____ = Total Cover				
Sapling/Shrub Stratum (Plot size: <u>5'</u>)	Absolute % Cover	Dominant Species?	Indicator Status	Prevalence Index worksheet:
1. _____	_____	_____	_____	Total % Cover of: _____ Multiply by: _____
2. _____	_____	_____	_____	OBL species _____ x 1 = _____
3. _____	_____	_____	_____	FACW species _____ x 2 = _____
4. _____	_____	_____	_____	FAC species _____ x 3 = _____
5. _____	_____	_____	_____	FACU species _____ x 4 = _____
_____ = Total Cover				UPL species _____ x 5 = _____
				Column Totals: _____ (A) _____ (B)
				Prevalence Index = B/A = _____
Herb Stratum (Plot size: <u>5'</u>)	Absolute % Cover	Dominant Species?	Indicator Status	Hydrophytic Vegetation Indicators:
1. <u>Avena barbata</u>	<u>30</u>	<u>Y</u>	<u>UPL</u>	<input type="checkbox"/> Dominance Test is >50%
2. <u>Bromus diandrus</u>	<u>30</u>	<u>Y</u>	<u>UPL</u>	<input type="checkbox"/> Prevalence Index is ≤3.0 ¹
3. <u>Vicia villosa</u>	<u>20</u>	<u>Y</u>	<u>UPL</u>	<input type="checkbox"/> Morphological Adaptations ¹ (Provide supporting data in Remarks or on a separate sheet)
4. <u>Raphanus sativus</u>	<u>10</u>	<u>N</u>	<u>UPL</u>	<input type="checkbox"/> Problematic Hydrophytic Vegetation ¹ (Explain)
5. <u>Geranium dissectum</u>	<u>5</u>	<u>N</u>	<u>UPL</u>	
6. _____	_____	_____	_____	
7. _____	_____	_____	_____	
8. _____	_____	_____	_____	
<u>95</u> = Total Cover				
Woody Vine Stratum (Plot size: <u>5'</u>)	Absolute % Cover	Dominant Species?	Indicator Status	Footnote:
1. _____	_____	_____	_____	¹ Indicators of hydric soil and wetland hydrology must be present, unless disturbed or problematic.
2. _____	_____	_____	_____	
_____ = Total Cover				
% Bare Ground in Herb Stratum <u>5</u> % Cover of Biotic Crust _____				Hydrophytic Vegetation Present? Yes <input type="checkbox"/> No <input checked="" type="checkbox"/>

Remarks:
 Sample point dominated by upland vegetation.

SOIL

Sampling Point: 2b

Profile Description: (Describe to the depth needed to document the indicator or confirm the absence of indicators.)

Depth (inches)	Matrix		Redox Features				Texture	Remarks
	Color (moist)	%	Color (moist)	%	Type ¹	Loc ²		
0-6	10YR 3/2	100	none				clay loam	
6-16	10YR 2/2	99+	10YR 5/6	<1	C	M/PL	clay loam	

¹Type: C=Concentration, D=Depletion, RM=Reduced Matrix, CS=Covered or Coated Sand Grains. ²Location: PL=Pore Lining, M=Matrix.

Hydric Soil Indicators: (Applicable to all LRRs, unless otherwise noted.)

- Histosol (A1)
- Histic Epipedon (A2)
- Black Histic (A3)
- Hydrogen Sulfide (A4)
- Stratified Layers (A5) (LRR C)
- 1 cm Muck (A9) (LRR D)
- Depleted Below Dark Surface (A11)
- Thick Dark Surface (A12)
- Sandy Mucky Mineral (S1)
- Sandy Gleyed Matrix (S4)

- Sandy Redox (S5)
- Stripped Matrix (S6)
- Loamy Mucky Mineral (F1)
- Loamy Gleyed Matrix (F2)
- Depleted Matrix (F3)
- Redox Dark Surface (F6)
- Depleted Dark Surface (F7)
- Redox Depressions (F8)
- ~~Vernal Pools (F9)~~

Indicators for Problematic Hydric Soils³:

- 1 cm Muck (A9) (LRR C)
- 2 cm Muck (A10) (LRR B)
- Reduced Vertic (F18)
- Red Parent Material (TF2)
- Other (Explain in Remarks)

³Indicators of hydrophytic vegetation and wetland hydrology must be present, unless disturbed or problematic.

Restrictive Layer (if present):

Type: none
 Depth (inches): _____

Hydric Soil Present? Yes _____ No

Remarks:

Faint redox in subsoil, but insufficient to meet hydric indicator. No hydric indicators observed.

HYDROLOGY

Wetland Hydrology Indicators:

Primary Indicators (minimum of one required; check all that apply)		Secondary Indicators (2 or more required)
<input type="checkbox"/> Surface Water (A1)	<input type="checkbox"/> Salt Crust (B11)	<input type="checkbox"/> Water Marks (B1) (Riverine)
<input type="checkbox"/> High Water Table (A2)	<input type="checkbox"/> Biotic Crust (B12)	<input type="checkbox"/> Sediment Deposits (B2) (Riverine)
<input type="checkbox"/> Saturation (A3)	<input type="checkbox"/> Aquatic Invertebrates (B13)	<input type="checkbox"/> Drift Deposits (B3) (Riverine)
<input type="checkbox"/> Water Marks (B1) (Nonriverine)	<input type="checkbox"/> Hydrogen Sulfide Odor (C1)	<input type="checkbox"/> Drainage Patterns (B10)
<input type="checkbox"/> Sediment Deposits (B2) (Nonriverine)	<input type="checkbox"/> Oxidized Rhizospheres along Living Roots (C3)	<input type="checkbox"/> Dry-Season Water Table (C2)
<input type="checkbox"/> Drift Deposits (B3) (Nonriverine)	<input type="checkbox"/> Presence of Reduced Iron (C4)	<input type="checkbox"/> Crayfish Burrows (C8)
<input type="checkbox"/> Surface Soil Cracks (B6)	<input type="checkbox"/> Recent Iron Reduction in Tilled Soils (C6)	<input type="checkbox"/> Saturation Visible on Aerial Imagery (C9)
<input type="checkbox"/> Inundation Visible on Aerial Imagery (B7)	<input type="checkbox"/> Thin Muck Surface (C7)	<input type="checkbox"/> Shallow Aquitard (D3)
<input type="checkbox"/> Water-Stained Leaves (B9)	<input type="checkbox"/> Other (Explain in Remarks)	<input type="checkbox"/> FAC-Neutral Test (D5)

Field Observations:

Surface Water Present? Yes _____ No Depth (inches): None
 Water Table Present? Yes _____ No Depth (inches): None
 Saturation Present? (includes capillary fringe) Yes _____ No Depth (inches): None

Wetland Hydrology Present? Yes _____ No

Describe Recorded Data (stream gauge, monitoring well, aerial photos, previous inspections), if available:

None

Remarks:

No wetland hydrology indicators observed.

WETLAND DETERMINATION DATA FORM – Arid West Region

Project/Site: Lakeview Estates (APN 051-411-20) City/County: Watsonville, Santa Cruz Co. Sampling Date: 5/22/18
 Applicant/Owner: Raeid Farhat State: CA Sampling Point: 3
 Investigator(s): T. Mahony, Coast Range Biological LLC Section, Township, Range: Mt. Diablo Meridian, T11S,R2E,sec21
 Landform (hillslope, terrace, etc.): ditch Local relief (concave, convex, none): concave Slope (%): 5
 Subregion (LRR): Mediterranean CA (LRR C) Lat: 36.956898 Long: -121.759641 Datum: NAD 83
 Soil Map Unit Name: Pinto loam, 9 to 15 percent slopes NWI classification: None

Are climatic / hydrologic conditions on the site typical for this time of year? Yes No (If no, explain in Remarks.)
 Are Vegetation , Soil , or Hydrology significantly disturbed? Are "Normal Circumstances" present? Yes No
 Are Vegetation , Soil , or Hydrology naturally problematic? (If needed, explain any answers in Remarks.)

SUMMARY OF FINDINGS – Attach site map showing sampling point locations, transects, important features, etc.

Hydrophytic Vegetation Present? Yes <input type="checkbox"/> No <input checked="" type="checkbox"/> Hydric Soil Present? Yes <input checked="" type="checkbox"/> No <input type="checkbox"/> Wetland Hydrology Present? Yes <input type="checkbox"/> No <input checked="" type="checkbox"/>	Is the Sampled Area within a Wetland? Yes <input type="checkbox"/> No <input checked="" type="checkbox"/>
Remarks: Seasonal hydrology naturally problematic. Located in man-made drainage ditch. Hydric soil indicators present (likely due to topographic position) but upland vegetation present and wetland hydrology absent. Sample point located in upland.	

VEGETATION – Use scientific names of plants.

Tree Stratum (Plot size: <u>10'</u>)	Absolute % Cover	Dominant Species?	Indicator Status	Dominance Test worksheet:
1. _____	_____	_____	_____	Number of Dominant Species That Are OBL, FACW, or FAC: <u>0</u> (A)
2. _____	_____	_____	_____	Total Number of Dominant Species Across All Strata: <u>1</u> (B)
3. _____	_____	_____	_____	Percent of Dominant Species That Are OBL, FACW, or FAC: <u>0</u> (A/B)
4. _____	_____	_____	_____	
_____ = Total Cover				
Sapling/Shrub Stratum (Plot size: <u>5'</u>)	Absolute % Cover	Dominant Species?	Indicator Status	Prevalence Index worksheet:
1. _____	_____	_____	_____	Total % Cover of: _____ Multiply by: _____
2. _____	_____	_____	_____	OBL species _____ x 1 = _____
3. _____	_____	_____	_____	FACW species _____ x 2 = _____
4. _____	_____	_____	_____	FAC species <u>10</u> x 3 = <u>30</u>
5. _____	_____	_____	_____	FACU species <u>17</u> x 4 = <u>68</u>
_____ = Total Cover				UPL species <u>69</u> x 5 = <u>345</u>
				Column Totals: <u>96</u> (A) <u>443</u> (B)
Prevalence Index = B/A = <u>4.6</u>				
Herb Stratum (Plot size: <u>5'</u>)	Absolute % Cover	Dominant Species?	Indicator Status	Hydrophytic Vegetation Indicators:
1. <u>Avena barbata</u>	<u>2</u>	<u>N</u>	<u>UPL</u>	<input type="checkbox"/> Dominance Test is >50%
2. <u>Bromus diandrus</u>	<u>2</u>	<u>N</u>	<u>UPL</u>	<input type="checkbox"/> Prevalence Index is ≤3.0 ¹
3. <u>Carduus pycnocephalus</u>	<u>60</u>	<u>Y</u>	<u>UPL</u>	<input type="checkbox"/> Morphological Adaptations ¹ (Provide supporting data in Remarks or on a separate sheet)
4. <u>Festuca perennis</u>	<u>10</u>	<u>N</u>	<u>FAC</u>	<input type="checkbox"/> Problematic Hydrophytic Vegetation ¹ (Explain)
5. <u>Rumex acetosella</u>	<u>10</u>	<u>N</u>	<u>FACU</u>	
6. <u>Hordeum murinum</u>	<u>5</u>	<u>N</u>	<u>FACU</u>	
7. <u>Eschscholzia californica</u>	<u>5</u>	<u>N</u>	<u>UPL</u>	
8. <u>Erodium botrys</u>	<u>2</u>	<u>N</u>	<u>FACU</u>	
_____ = Total Cover				
Woody Vine Stratum (Plot size: <u>5'</u>)	Absolute % Cover	Dominant Species?	Indicator Status	Footnote:
1. _____	_____	_____	_____	¹ Indicators of hydric soil and wetland hydrology must be present, unless disturbed or problematic.
2. _____	_____	_____	_____	
_____ = Total Cover				
% Bare Ground in Herb Stratum <u>5</u> % Cover of Biotic Crust _____				Hydrophytic Vegetation Present? Yes <input type="checkbox"/> No <input checked="" type="checkbox"/>

Remarks:
 Sample point dominated by upland vegetation.

SOIL

Sampling Point: 3

Profile Description: (Describe to the depth needed to document the indicator or confirm the absence of indicators.)

Depth (inches)	Matrix		Redox Features				Texture	Remarks
	Color (moist)	%	Color (moist)	%	Type ¹	Loc ²		
0-4	10YR 3/2	100	none				clay loam	
4-16	10YR 2/2	85	10YR 5/8	15	C	M	clay loam	

¹Type: C=Concentration, D=Depletion, RM=Reduced Matrix, CS=Covered or Coated Sand Grains. ²Location: PL=Pore Lining, M=Matrix.

Hydric Soil Indicators: (Applicable to all LRRs, unless otherwise noted.)

- Histosol (A1)
- Histic Epipedon (A2)
- Black Histic (A3)
- Hydrogen Sulfide (A4)
- Stratified Layers (A5) (LRR C)
- 1 cm Muck (A9) (LRR D)
- Depleted Below Dark Surface (A11)
- Thick Dark Surface (A12)
- Sandy Mucky Mineral (S1)
- Sandy Gleyed Matrix (S4)

- Sandy Redox (S5)
- Stripped Matrix (S6)
- Loamy Mucky Mineral (F1)
- Loamy Gleyed Matrix (F2)
- Depleted Matrix (F3)
- Redox Dark Surface (F6)
- Depleted Dark Surface (F7)
- Redox Depressions (F8)
- ~~Vernal Pools (F9)~~

Indicators for Problematic Hydric Soils³:

- 1 cm Muck (A9) (LRR C)
- 2 cm Muck (A10) (LRR B)
- Reduced Vertic (F18)
- Red Parent Material (TF2)
- Other (Explain in Remarks)

³Indicators of hydrophytic vegetation and wetland hydrology must be present, unless disturbed or problematic.

Restrictive Layer (if present):

Type: none
 Depth (inches): _____

Hydric Soil Present? Yes No

Remarks:

Hydric soil indicators observed in subsoil.

HYDROLOGY

Wetland Hydrology Indicators:

Primary Indicators (minimum of one required; check all that apply)

- Surface Water (A1)
- High Water Table (A2)
- Saturation (A3)
- Water Marks (B1) (Nonriverine)
- Sediment Deposits (B2) (Nonriverine)
- Drift Deposits (B3) (Nonriverine)
- Surface Soil Cracks (B6)
- Inundation Visible on Aerial Imagery (B7)
- Water-Stained Leaves (B9)

- Salt Crust (B11)
- Biotic Crust (B12)
- Aquatic Invertebrates (B13)
- Hydrogen Sulfide Odor (C1)
- Oxidized Rhizospheres along Living Roots (C3)
- Presence of Reduced Iron (C4)
- Recent Iron Reduction in Tilled Soils (C6)
- Thin Muck Surface (C7)
- Other (Explain in Remarks)

Secondary Indicators (2 or more required)

- Water Marks (B1) (Riverine)
- Sediment Deposits (B2) (Riverine)
- Drift Deposits (B3) (Riverine)
- Drainage Patterns (B10)
- Dry-Season Water Table (C2)
- Crayfish Burrows (C8)
- Saturation Visible on Aerial Imagery (C9)
- Shallow Aquitard (D3)
- FAC-Neutral Test (D5)

Field Observations:

Surface Water Present? Yes _____ No Depth (inches): None
 Water Table Present? Yes _____ No Depth (inches): None
 Saturation Present? (includes capillary fringe) Yes _____ No Depth (inches): None

Wetland Hydrology Present? Yes _____ No

Describe Recorded Data (stream gauge, monitoring well, aerial photos, previous inspections), if available:

None

Remarks:

Located in man-made ditch. Due to topographic position, collects water from surrounding slopes, and, based on hydric soil indicators in subsoil, likely supports some saturation in subsoil, but surface hydrology indicators generally lacking. Likely conveys surface and/or near-surface hydrology during rain events toward Wetland 2, but wetland hydrology indicators, along with an Ordinary High Water Mark, lacking.

WETLAND DETERMINATION DATA FORM – Arid West Region

Project/Site: Lakeview Estates (APN 051-411-20) City/County: Watsonville, Santa Cruz Co. Sampling Date: 5/22/18
 Applicant/Owner: Raeid Farhat State: CA Sampling Point: 4
 Investigator(s): T. Mahony, Coast Range Biological LLC Section, Township, Range: Mt. Diablo Meridian, T11S,R2E,sec21
 Landform (hillslope, terrace, etc.): ditch Local relief (concave, convex, none): concave Slope (%): 10
 Subregion (LRR): Mediterranean CA (LRR C) Lat: 36.957070 Long: -121.759526 Datum: NAD 83
 Soil Map Unit Name: Pinto loam, 9 to 15 percent slopes NWI classification: None

Are climatic / hydrologic conditions on the site typical for this time of year? Yes No (If no, explain in Remarks.)
 Are Vegetation , Soil , or Hydrology significantly disturbed? Are "Normal Circumstances" present? Yes No
 Are Vegetation , Soil , or Hydrology naturally problematic? (If needed, explain any answers in Remarks.)

SUMMARY OF FINDINGS – Attach site map showing sampling point locations, transects, important features, etc.

Hydrophytic Vegetation Present? Yes <input type="checkbox"/> No <input checked="" type="checkbox"/> Hydric Soil Present? Yes <input checked="" type="checkbox"/> No <input type="checkbox"/> Wetland Hydrology Present? Yes <input type="checkbox"/> No <input checked="" type="checkbox"/>	Is the Sampled Area within a Wetland? Yes <input type="checkbox"/> No <input checked="" type="checkbox"/>
Remarks: Seasonal hydrology naturally problematic. Located in man-made drainage ditch. Hydric soil indicators present (likely due to topographic position) but upland vegetation present and wetland hydrology absent. Sample point located in upland.	

VEGETATION – Use scientific names of plants.

Tree Stratum (Plot size: <u>10'</u>)	Absolute % Cover	Dominant Species?	Indicator Status	Dominance Test worksheet:
1. _____	_____	_____	_____	Number of Dominant Species That Are OBL, FACW, or FAC: <u>1</u> (A) Total Number of Dominant Species Across All Strata: <u>3</u> (B) Percent of Dominant Species That Are OBL, FACW, or FAC: <u>33</u> (A/B)
2. _____	_____	_____	_____	
3. _____	_____	_____	_____	
4. _____	_____	_____	_____	
= Total Cover				Prevalence Index worksheet: Total % Cover of: _____ Multiply by: _____ OBL species _____ x 1 = _____ FACW species _____ x 2 = _____ FAC species <u>25</u> x 3 = <u>75</u> FACU species <u>20</u> x 4 = <u>80</u> UPL species <u>50</u> x 5 = <u>250</u> Column Totals: <u>95</u> (A) <u>405</u> (B) Prevalence Index = B/A = <u>4.26</u>
= Total Cover				
Sapling/Shrub Stratum (Plot size: <u>5'</u>) 1. _____ 2. _____ 3. _____ 4. _____ 5. _____				
= Total Cover				
Herb Stratum (Plot size: <u>5'</u>) 1. <u>Avena barbata</u> <u>25</u> <u>Y</u> <u>UPL</u> 2. <u>Bromus diandrus</u> <u>25</u> <u>Y</u> <u>UPL</u> 3. <u>Hordeum murinum</u> <u>10</u> <u>N</u> <u>FACU</u> 4. <u>Festuca perennis</u> <u>25</u> <u>Y</u> <u>FAC</u> 5. <u>Erodium botrys</u> <u>5</u> <u>N</u> <u>FACU</u> 6. <u>Vicia sativa</u> <u>5</u> <u>N</u> <u>FACU</u> 7. _____ 8. _____				
= Total Cover				
Woody Vine Stratum (Plot size: <u>5'</u>) 1. _____ 2. _____				
= Total Cover				
% Bare Ground in Herb Stratum <u>5</u> % Cover of Biotic Crust _____				
Remarks: Sample point dominated by upland vegetation.				

Hydrophytic Vegetation Present? Yes No

¹Indicators of hydric soil and wetland hydrology must be present, unless disturbed or problematic.

SOIL

Sampling Point: 4

Profile Description: (Describe to the depth needed to document the indicator or confirm the absence of indicators.)

Depth (inches)	Matrix		Redox Features				Texture	Remarks
	Color (moist)	%	Color (moist)	%	Type ¹	Loc ²		
0-8	10YR 3/3	100	none				loam	
8-20	10YR 3/2	95	10YR 5/8	5	C	M	clay loam	

¹Type: C=Concentration, D=Depletion, RM=Reduced Matrix, CS=Covered or Coated Sand Grains. ²Location: PL=Pore Lining, M=Matrix.

Hydric Soil Indicators: (Applicable to all LRRs, unless otherwise noted.)

- Histosol (A1)
- Histic Epipedon (A2)
- Black Histic (A3)
- Hydrogen Sulfide (A4)
- Stratified Layers (A5) (LRR C)
- 1 cm Muck (A9) (LRR D)
- Depleted Below Dark Surface (A11)
- Thick Dark Surface (A12)
- Sandy Mucky Mineral (S1)
- Sandy Gleyed Matrix (S4)

- Sandy Redox (S5)
- Stripped Matrix (S6)
- Loamy Mucky Mineral (F1)
- Loamy Gleyed Matrix (F2)
- Depleted Matrix (F3)
- Redox Dark Surface (F6)
- Depleted Dark Surface (F7)
- Redox Depressions (F8)
- ~~Vernal Pools (F9)~~

Indicators for Problematic Hydric Soils³:

- 1 cm Muck (A9) (LRR C)
- 2 cm Muck (A10) (LRR B)
- Reduced Vertic (F18)
- Red Parent Material (TF2)
- Other (Explain in Remarks)

³Indicators of hydrophytic vegetation and wetland hydrology must be present, unless disturbed or problematic.

Restrictive Layer (if present):

Type: none
 Depth (inches): _____

Hydric Soil Present? Yes No

Remarks:

Hydric soil indicators observed in subsoil.

HYDROLOGY

Wetland Hydrology Indicators:

Primary Indicators (minimum of one required; check all that apply)

- Surface Water (A1)
- High Water Table (A2)
- Saturation (A3)
- Water Marks (B1) (Nonriverine)
- Sediment Deposits (B2) (Nonriverine)
- Drift Deposits (B3) (Nonriverine)
- Surface Soil Cracks (B6)
- Inundation Visible on Aerial Imagery (B7)
- Water-Stained Leaves (B9)

- Salt Crust (B11)
- Biotic Crust (B12)
- Aquatic Invertebrates (B13)
- Hydrogen Sulfide Odor (C1)
- Oxidized Rhizospheres along Living Roots (C3)
- Presence of Reduced Iron (C4)
- Recent Iron Reduction in Tilled Soils (C6)
- Thin Muck Surface (C7)
- Other (Explain in Remarks)

Secondary Indicators (2 or more required)

- Water Marks (B1) (Riverine)
- Sediment Deposits (B2) (Riverine)
- Drift Deposits (B3) (Riverine)
- Drainage Patterns (B10)
- Dry-Season Water Table (C2)
- Crayfish Burrows (C8)
- Saturation Visible on Aerial Imagery (C9)
- Shallow Aquitard (D3)
- FAC-Neutral Test (D5)

Field Observations:

Surface Water Present? Yes No Depth (inches): None
 Water Table Present? Yes No Depth (inches): None
 Saturation Present? (includes capillary fringe) Yes No Depth (inches): None

Wetland Hydrology Present? Yes No

Describe Recorded Data (stream gauge, monitoring well, aerial photos, previous inspections), if available:

None

Remarks:

Located in man-made ditch. Due topographic position, collects water from surrounding slopes, and, based on hydric soil indicators in subsoil, likely supports some saturation in subsoil, but surface indicators generally lacking. Likely conveys surface and/or near-surface hydrology during rain events toward Wetland 2, but wetland hydrology indicators, along with an Ordinary High Water Mark, lacking.

WETLAND DETERMINATION DATA FORM – Arid West Region

Project/Site: Lakeview Estates (APN 051-411-20) City/County: Watsonville, Santa Cruz Co. Sampling Date: 5/22/18
 Applicant/Owner: Raeid Farhat State: CA Sampling Point: 5a
 Investigator(s): T. Mahony, Coast Range Biological LLC Section, Township, Range: Mt. Diablo Meridian, T11S,R2E,sec21
 Landform (hillslope, terrace, etc.): swale Local relief (concave, convex, none): concave Slope (%): 1
 Subregion (LRR): Mediterranean CA (LRR C) Lat: 36.957005 Long: -121.759296 Datum: NAD 83
 Soil Map Unit Name: Pinto loam, 9 to 15 percent slopes NWI classification: None

Are climatic / hydrologic conditions on the site typical for this time of year? Yes No (If no, explain in Remarks.)
 Are Vegetation , Soil , or Hydrology significantly disturbed? Are "Normal Circumstances" present? Yes No
 Are Vegetation , Soil , or Hydrology naturally problematic? (If needed, explain any answers in Remarks.)

SUMMARY OF FINDINGS – Attach site map showing sampling point locations, transects, important features, etc.

Hydrophytic Vegetation Present? Yes <input checked="" type="checkbox"/> No <input type="checkbox"/> Hydric Soil Present? Yes <input checked="" type="checkbox"/> No <input type="checkbox"/> Wetland Hydrology Present? Yes <input checked="" type="checkbox"/> No <input type="checkbox"/>	Is the Sampled Area within a Wetland? Yes <input checked="" type="checkbox"/> No <input type="checkbox"/>
Remarks: Seasonal hydrology naturally problematic. Located in swale at toe of slope that receives surface and near-surface water from upslope. All three wetland parameters met. Potential jurisdictional wetland.	

VEGETATION – Use scientific names of plants.

Tree Stratum (Plot size: <u>10'</u>)	Absolute % Cover	Dominant Species?	Indicator Status	
1. _____	_____	_____	_____	Dominance Test worksheet: Number of Dominant Species That Are OBL, FACW, or FAC: <u>4</u> (A) Total Number of Dominant Species Across All Strata: <u>4</u> (B) Percent of Dominant Species That Are OBL, FACW, or FAC: <u>100</u> (A/B)
2. _____	_____	_____	_____	
3. _____	_____	_____	_____	
4. _____	_____	_____	_____	
= Total Cover				Prevalence Index worksheet: Total % Cover of: _____ Multiply by: _____ OBL species _____ x 1 = _____ FACW species _____ x 2 = _____ FAC species _____ x 3 = _____ FACU species _____ x 4 = _____ UPL species _____ x 5 = _____ Column Totals: _____ (A) _____ (B) Prevalence Index = B/A = _____
Sapling/Shrub Stratum (Plot size: <u>5'</u>)				
1. <u>Rubus armeniacus</u>	<u>5</u>	<u>N</u>	<u>FAC</u>	
2. _____	_____	_____	_____	
3. _____	_____	_____	_____	
= Total Cover				
Herb Stratum (Plot size: <u>5'</u>)				
1. <u>Cyperus eragrostis</u>	<u>20</u>	<u>Y</u>	<u>FACW</u>	
2. <u>Mentha pulegium</u>	<u>20</u>	<u>Y</u>	<u>OBL</u>	
3. <u>Helminthotheca echioides</u>	<u>20</u>	<u>Y</u>	<u>FAC</u>	
4. <u>Lotus corniculatus</u>	<u>20</u>	<u>Y</u>	<u>FAC</u>	
5. <u>Polypogon monspeliensis</u>	<u>5</u>	<u>N</u>	<u>FACW</u>	
6. <u>Briza minor</u>	<u>5</u>	<u>N</u>	<u>FAC</u>	
7. <u>Vicia sativa</u>	<u>2</u>	<u>N</u>	<u>FACU</u>	
8. _____	_____	_____	_____	
= Total Cover				
Woody Vine Stratum (Plot size: <u>5'</u>)				
1. _____	_____	_____	_____	
2. _____	_____	_____	_____	
= Total Cover				
% Bare Ground in Herb Stratum <u>5</u> % Cover of Biotic Crust _____				
Remarks: Sample point dominated by hydrophytic vegetation.				

Hydrophytic Vegetation Present? Yes No

SOIL

Sampling Point: 5a

Profile Description: (Describe to the depth needed to document the indicator or confirm the absence of indicators.)

Depth (inches)	Matrix		Redox Features				Texture	Remarks
	Color (moist)	%	Color (moist)	%	Type ¹	Loc ²		
0-4	10YR 2/1	98	10YR 5/8	5	C	M/PL	clay loam	
4-10	10YR 2/1	90	5YR 5/8	10	C	M/PL	clay loam	
10-20	10YR 2/2	95	10YR 5/8	5	C	M/PL	clay	

¹Type: C=Concentration, D=Depletion, RM=Reduced Matrix, CS=Covered or Coated Sand Grains. ²Location: PL=Pore Lining, M=Matrix.

Hydric Soil Indicators: (Applicable to all LRRs, unless otherwise noted.)

- Histosol (A1)
- Histic Epipedon (A2)
- Black Histic (A3)
- Hydrogen Sulfide (A4)
- Stratified Layers (A5) (LRR C)
- 1 cm Muck (A9) (LRR D)
- Depleted Below Dark Surface (A11)
- Thick Dark Surface (A12)
- Sandy Mucky Mineral (S1)
- Sandy Gleyed Matrix (S4)

- Sandy Redox (S5)
- Stripped Matrix (S6)
- Loamy Mucky Mineral (F1)
- Loamy Gleyed Matrix (F2)
- Depleted Matrix (F3)
- Redox Dark Surface (F6)
- Depleted Dark Surface (F7)
- Redox Depressions (F8)
- ~~Vernal Pools (F9)~~

Indicators for Problematic Hydric Soils³:

- 1 cm Muck (A9) (LRR C)
- 2 cm Muck (A10) (LRR B)
- Reduced Vertic (F18)
- Red Parent Material (TF2)
- Other (Explain in Remarks)

³Indicators of hydrophytic vegetation and wetland hydrology must be present, unless disturbed or problematic.

Restrictive Layer (if present):

Type: none
 Depth (inches): _____

Hydric Soil Present? Yes No

Remarks:

Hydric soil indicators observed.

HYDROLOGY

Wetland Hydrology Indicators:

Primary Indicators (minimum of one required; check all that apply)

- Surface Water (A1)
- High Water Table (A2)
- Saturation (A3)
- Water Marks (B1) (Nonriverine)
- Sediment Deposits (B2) (Nonriverine)
- Drift Deposits (B3) (Nonriverine)
- Surface Soil Cracks (B6)
- Inundation Visible on Aerial Imagery (B7)
- Water-Stained Leaves (B9)

- Salt Crust (B11)
- Biotic Crust (B12)
- Aquatic Invertebrates (B13)
- Hydrogen Sulfide Odor (C1)
- Oxidized Rhizospheres along Living Roots (C3)
- Presence of Reduced Iron (C4)
- Recent Iron Reduction in Tilled Soils (C6)
- Thin Muck Surface (C7)
- Other (Explain in Remarks)

Secondary Indicators (2 or more required)

- Water Marks (B1) (Riverine)
- Sediment Deposits (B2) (Riverine)
- Drift Deposits (B3) (Riverine)
- Drainage Patterns (B10)
- Dry-Season Water Table (C2)
- Crayfish Burrows (C8)
- Saturation Visible on Aerial Imagery (C9)
- Shallow Aquitard (D3)
- FAC-Neutral Test (D5)

Field Observations:

Surface Water Present? Yes No Depth (inches): None
 Water Table Present? Yes No Depth (inches): None
 Saturation Present? (includes capillary fringe) Yes No Depth (inches): None

Wetland Hydrology Present? Yes No

Describe Recorded Data (stream gauge, monitoring well, aerial photos, previous inspections), if available:

None

Remarks:

Located in swale at toe of slope that receives surface (sheet flow, two man-made ditches) and subsurface discharge from slope. Wetland delineated to edge of three parameters, but concave area continues south and the wetland appears to continue to discharge south and east, off study area. No culvert or channelize flow observed, but likely drains via sheet flow toward southeast, off study area, and potentially into offsite creek. Connection to creek not investigated because it is located off the study area.

WETLAND DETERMINATION DATA FORM – Arid West Region

Project/Site: Lakeview Estates (APN 051-411-20) City/County: Watsonville, Santa Cruz Co. Sampling Date: 5/22/18
 Applicant/Owner: Raeid Farhat State: CA Sampling Point: 5b
 Investigator(s): T. Mahony, Coast Range Biological LLC Section, Township, Range: Mt. Diablo Meridian, T11S,R2E,sec21
 Landform (hillslope, terrace, etc.): slope Local relief (concave, convex, none): convex Slope (%): 15
 Subregion (LRR): Mediterranean CA (LRR C) Lat: 36.956994 Long: -121.759342 Datum: NAD 83
 Soil Map Unit Name: Pinto loam, 9 to 15 percent slopes NWI classification: None

Are climatic / hydrologic conditions on the site typical for this time of year? Yes No (If no, explain in Remarks.)
 Are Vegetation , Soil , or Hydrology significantly disturbed? Are "Normal Circumstances" present? Yes No
 Are Vegetation , Soil , or Hydrology naturally problematic? (If needed, explain any answers in Remarks.)

SUMMARY OF FINDINGS – Attach site map showing sampling point locations, transects, important features, etc.

Hydrophytic Vegetation Present? Yes <input type="checkbox"/> No <input checked="" type="checkbox"/> Hydric Soil Present? Yes <input type="checkbox"/> No <input checked="" type="checkbox"/> Wetland Hydrology Present? Yes <input type="checkbox"/> No <input checked="" type="checkbox"/>	Is the Sampled Area within a Wetland? Yes <input type="checkbox"/> No <input checked="" type="checkbox"/>
Remarks: Seasonal hydrology naturally problematic. No wetland indicators observed. Sample point located in upland.	

VEGETATION – Use scientific names of plants.

Tree Stratum (Plot size: <u>10'</u>)	Absolute % Cover	Dominant Species?	Indicator Status	
1. _____	_____	_____	_____	Dominance Test worksheet: Number of Dominant Species That Are OBL, FACW, or FAC: <u>1</u> (A) Total Number of Dominant Species Across All Strata: <u>3</u> (B) Percent of Dominant Species That Are OBL, FACW, or FAC: <u>33</u> (A/B)
2. _____	_____	_____	_____	
3. _____	_____	_____	_____	
4. _____	_____	_____	_____	
= Total Cover				Prevalence Index worksheet: Total % Cover of: _____ Multiply by: OBL species _____ x 1 = _____ FACW species _____ x 2 = _____ FAC species _____ x 3 = _____ FACU species _____ x 4 = _____ UPL species _____ x 5 = _____ Column Totals: _____ (A) _____ (B) Prevalence Index = B/A = _____
Sapling/Shrub Stratum (Plot size: <u>5'</u>)				
1. <u>Rubus ursinus</u>	<u>5</u>	<u>N</u>	<u>FAC</u>	
2. _____	_____	_____	_____	
3. _____	_____	_____	_____	
4. _____	_____	_____	_____	
5. _____	_____	_____	_____	
= Total Cover				
Herb Stratum (Plot size: <u>5'</u>)				
1. <u>Avena barbata</u>	<u>25</u>	<u>Y</u>	<u>UPL</u>	
2. <u>Bromus diandrus</u>	<u>40</u>	<u>Y</u>	<u>UPL</u>	
3. <u>Festuca perennis</u>	<u>20</u>	<u>Y</u>	<u>FAC</u>	
4. <u>Vicia sativa</u>	<u>5</u>	<u>N</u>	<u>FACU</u>	
5. <u>Plantago lanceolata</u>	<u>2</u>	<u>N</u>	<u>FAC</u>	
6. <u>Erodium botrys</u>	<u>2</u>	<u>N</u>	<u>FACU</u>	
7. _____	_____	_____	_____	
8. _____	_____	_____	_____	
= Total Cover				
Woody Vine Stratum (Plot size: <u>5'</u>)				
1. _____	_____	_____	_____	
2. _____	_____	_____	_____	
= Total Cover				
% Bare Ground in Herb Stratum <u>5</u> % Cover of Biotic Crust _____				
Hydrophytic Vegetation Indicators: ___ Dominance Test is >50% ___ Prevalence Index is ≤3.0 ¹ ___ Morphological Adaptations ¹ (Provide supporting data in Remarks or on a separate sheet) ___ Problematic Hydrophytic Vegetation ¹ (Explain)				
¹ Indicators of hydric soil and wetland hydrology must be present, unless disturbed or problematic.				
Hydrophytic Vegetation Present? Yes <input type="checkbox"/> No <input checked="" type="checkbox"/>				

Remarks:
 Sample point dominated by upland vegetation.

SOIL

Sampling Point: 5b

Profile Description: (Describe to the depth needed to document the indicator or confirm the absence of indicators.)

Depth (inches)	Matrix		Redox Features				Texture	Remarks
	Color (moist)	%	Color (moist)	%	Type ¹	Loc ²		
0-8	10YR 2/2	100	none				clay loam	
8-16	10YR 3/2	100	none				clay	

¹Type: C=Concentration, D=Depletion, RM=Reduced Matrix, CS=Covered or Coated Sand Grains. ²Location: PL=Pore Lining, M=Matrix.

Hydric Soil Indicators: (Applicable to all LRRs, unless otherwise noted.)

- Histosol (A1)
- Histic Epipedon (A2)
- Black Histic (A3)
- Hydrogen Sulfide (A4)
- Stratified Layers (A5) (LRR C)
- 1 cm Muck (A9) (LRR D)
- Depleted Below Dark Surface (A11)
- Thick Dark Surface (A12)
- Sandy Mucky Mineral (S1)
- Sandy Gleyed Matrix (S4)

- Sandy Redox (S5)
- Stripped Matrix (S6)
- Loamy Mucky Mineral (F1)
- Loamy Gleyed Matrix (F2)
- Depleted Matrix (F3)
- Redox Dark Surface (F6)
- Depleted Dark Surface (F7)
- Redox Depressions (F8)
- ~~Vernal Pools (F9)~~

Indicators for Problematic Hydric Soils³:

- 1 cm Muck (A9) (LRR C)
- 2 cm Muck (A10) (LRR B)
- Reduced Vertic (F18)
- Red Parent Material (TF2)
- Other (Explain in Remarks)

³Indicators of hydrophytic vegetation and wetland hydrology must be present, unless disturbed or problematic.

Restrictive Layer (if present):

Type: none
 Depth (inches): _____

Hydric Soil Present? Yes _____ No

Remarks:

No hydric indicators observed.

HYDROLOGY

Wetland Hydrology Indicators:

Primary Indicators (minimum of one required; check all that apply)		Secondary Indicators (2 or more required)
<input type="checkbox"/> Surface Water (A1)	<input type="checkbox"/> Salt Crust (B11)	<input type="checkbox"/> Water Marks (B1) (Riverine)
<input type="checkbox"/> High Water Table (A2)	<input type="checkbox"/> Biotic Crust (B12)	<input type="checkbox"/> Sediment Deposits (B2) (Riverine)
<input type="checkbox"/> Saturation (A3)	<input type="checkbox"/> Aquatic Invertebrates (B13)	<input type="checkbox"/> Drift Deposits (B3) (Riverine)
<input type="checkbox"/> Water Marks (B1) (Nonriverine)	<input type="checkbox"/> Hydrogen Sulfide Odor (C1)	<input type="checkbox"/> Drainage Patterns (B10)
<input type="checkbox"/> Sediment Deposits (B2) (Nonriverine)	<input type="checkbox"/> Oxidized Rhizospheres along Living Roots (C3)	<input type="checkbox"/> Dry-Season Water Table (C2)
<input type="checkbox"/> Drift Deposits (B3) (Nonriverine)	<input type="checkbox"/> Presence of Reduced Iron (C4)	<input type="checkbox"/> Crayfish Burrows (C8)
<input type="checkbox"/> Surface Soil Cracks (B6)	<input type="checkbox"/> Recent Iron Reduction in Tilled Soils (C6)	<input type="checkbox"/> Saturation Visible on Aerial Imagery (C9)
<input type="checkbox"/> Inundation Visible on Aerial Imagery (B7)	<input type="checkbox"/> Thin Muck Surface (C7)	<input type="checkbox"/> Shallow Aquitard (D3)
<input type="checkbox"/> Water-Stained Leaves (B9)	<input type="checkbox"/> Other (Explain in Remarks)	<input type="checkbox"/> FAC-Neutral Test (D5)

Field Observations:

Surface Water Present? Yes _____ No Depth (inches): None
 Water Table Present? Yes _____ No Depth (inches): None
 Saturation Present? (includes capillary fringe) Yes _____ No Depth (inches): None

Wetland Hydrology Present? Yes _____ No

Describe Recorded Data (stream gauge, monitoring well, aerial photos, previous inspections), if available:

None

Remarks:

No wetland hydrology indicators observed.

WETLAND DETERMINATION DATA FORM – Arid West Region

Project/Site: Lakeview Estates (APN 051-411-20) City/County: Watsonville, Santa Cruz Co. Sampling Date: 5/22/18
 Applicant/Owner: Raeid Farhat State: CA Sampling Point: 6a
 Investigator(s): T. Mahony, Coast Range Biological LLC Section, Township, Range: Mt. Diablo Meridian, T11S,R2E,sec21
 Landform (hillslope, terrace, etc.): swale Local relief (concave, convex, none): concave Slope (%): 2
 Subregion (LRR): Mediterranean CA (LRR C) Lat: 36.957256 Long: -121.759338 Datum: NAD 83
 Soil Map Unit Name: Pinto loam, 9 to 15 percent slopes NWI classification: None

Are climatic / hydrologic conditions on the site typical for this time of year? Yes No (If no, explain in Remarks.)
 Are Vegetation , Soil , or Hydrology significantly disturbed? Are "Normal Circumstances" present? Yes No
 Are Vegetation , Soil , or Hydrology naturally problematic? (If needed, explain any answers in Remarks.)

SUMMARY OF FINDINGS – Attach site map showing sampling point locations, transects, important features, etc.

Hydrophytic Vegetation Present? Yes <input checked="" type="checkbox"/> No <input type="checkbox"/> Hydric Soil Present? Yes <input checked="" type="checkbox"/> No <input type="checkbox"/> Wetland Hydrology Present? Yes <input checked="" type="checkbox"/> No <input type="checkbox"/>	Is the Sampled Area within a Wetland? Yes <input checked="" type="checkbox"/> No <input type="checkbox"/>
Remarks: Seasonal hydrology naturally problematic. Veg regenerating from past disturbance. Located in swale at toe of slope that receives surface and near-surface water from upslope. All three wetland parameters met. Potential jurisdictional wetland.	

VEGETATION – Use scientific names of plants.

Tree Stratum (Plot size: <u>10'</u>)	Absolute % Cover	Dominant Species?	Indicator Status	
1. _____	_____	_____	_____	Dominance Test worksheet: Number of Dominant Species That Are OBL, FACW, or FAC: <u>3</u> (A) Total Number of Dominant Species Across All Strata: <u>3</u> (B) Percent of Dominant Species That Are OBL, FACW, or FAC: <u>100</u> (A/B)
2. _____	_____	_____	_____	
3. _____	_____	_____	_____	
4. _____	_____	_____	_____	
_____ = Total Cover				Prevalence Index worksheet: Total % Cover of: _____ Multiply by: OBL species _____ x 1 = _____ FACW species _____ x 2 = _____ FAC species _____ x 3 = _____ FACU species _____ x 4 = _____ UPL species _____ x 5 = _____ Column Totals: _____ (A) _____ (B) Prevalence Index = B/A = _____
Sapling/Shrub Stratum (Plot size: <u>5'</u>)				
1. <u>Rubus armeniacus</u>	<u>5</u>	<u>N</u>	<u>FAC</u>	
2. <u>Toxicodendron diversilobum</u>	<u>5</u>	<u>N</u>	<u>FACU</u>	
3. _____	_____	_____	_____	
4. _____	_____	_____	_____	
5. _____	_____	_____	_____	
<u>10</u> = Total Cover				
Herb Stratum (Plot size: <u>5'</u>)				
1. <u>Cyperus eragrostis</u>	<u>25</u>	<u>Y</u>	<u>FACW</u>	
2. <u>Mentha pulegium</u>	<u>5</u>	<u>N</u>	<u>OBL</u>	
3. <u>Bromus hordeaceus</u>	<u>5</u>	<u>N</u>	<u>FACU</u>	
4. <u>Festuca perennis</u>	<u>25</u>	<u>Y</u>	<u>FAC</u>	
5. <u>Polygonum monspeliensis</u>	<u>25</u>	<u>Y</u>	<u>FACW</u>	
6. <u>Persicaria sp.</u>	<u>5</u>	<u>N</u>	_____	
7. _____	_____	_____	_____	
8. _____	_____	_____	_____	
<u>90</u> = Total Cover				
Woody Vine Stratum (Plot size: <u>5'</u>)				
1. _____	_____	_____	_____	
2. _____	_____	_____	_____	
_____ = Total Cover				
% Bare Ground in Herb Stratum <u>5</u> % Cover of Biotic Crust _____				
Hydrophytic Vegetation Indicators: <input checked="" type="checkbox"/> Dominance Test is >50% <input type="checkbox"/> Prevalence Index is ≤3.0 ¹ <input type="checkbox"/> Morphological Adaptations ¹ (Provide supporting data in Remarks or on a separate sheet) <input type="checkbox"/> Problematic Hydrophytic Vegetation ¹ (Explain)				
¹ Indicators of hydric soil and wetland hydrology must be present, unless disturbed or problematic.				
Hydrophytic Vegetation Present? Yes <input checked="" type="checkbox"/> No <input type="checkbox"/>				

Remarks:
 Sample point dominated by hydrophytic vegetation. Dense area of regenerating Salix sp. in wetland, but outside of sample point.

SOIL

Sampling Point: 6a

Profile Description: (Describe to the depth needed to document the indicator or confirm the absence of indicators.)

Depth (inches)	Matrix		Redox Features				Texture	Remarks
	Color (moist)	%	Color (moist)	%	Type ¹	Loc ²		
0-8	10YR 2/1	95	10YR 4/6	5	C	M/PL	clay loam	
8-16	10YR 3/1	95	10YR 4/6	5	C	M/PL	clay	

¹Type: C=Concentration, D=Depletion, RM=Reduced Matrix, CS=Covered or Coated Sand Grains. ²Location: PL=Pore Lining, M=Matrix.

Hydric Soil Indicators: (Applicable to all LRRs, unless otherwise noted.)

- Histosol (A1)
- Histic Epipedon (A2)
- Black Histic (A3)
- Hydrogen Sulfide (A4)
- Stratified Layers (A5) (LRR C)
- 1 cm Muck (A9) (LRR D)
- Depleted Below Dark Surface (A11)
- Thick Dark Surface (A12)
- Sandy Mucky Mineral (S1)
- Sandy Gleyed Matrix (S4)

- Sandy Redox (S5)
- Stripped Matrix (S6)
- Loamy Mucky Mineral (F1)
- Loamy Gleyed Matrix (F2)
- Depleted Matrix (F3)
- Redox Dark Surface (F6)
- Depleted Dark Surface (F7)
- Redox Depressions (F8)
- ~~Vernal Pools (F9)~~

Indicators for Problematic Hydric Soils³:

- 1 cm Muck (A9) (LRR C)
- 2 cm Muck (A10) (LRR B)
- Reduced Vertic (F18)
- Red Parent Material (TF2)
- Other (Explain in Remarks)

³Indicators of hydrophytic vegetation and wetland hydrology must be present, unless disturbed or problematic.

Restrictive Layer (if present):

Type: none
 Depth (inches): _____

Hydric Soil Present? Yes No

Remarks:

Hydric soil indicators observed.

HYDROLOGY

Wetland Hydrology Indicators:

Primary Indicators (minimum of one required; check all that apply)

- Surface Water (A1)
- High Water Table (A2)
- Saturation (A3)
- Water Marks (B1) (Nonriverine)
- Sediment Deposits (B2) (Nonriverine)
- Drift Deposits (B3) (Nonriverine)
- Surface Soil Cracks (B6)
- Inundation Visible on Aerial Imagery (B7)
- Water-Stained Leaves (B9)

- Salt Crust (B11)
- Biotic Crust (B12)
- Aquatic Invertebrates (B13)
- Hydrogen Sulfide Odor (C1)
- Oxidized Rhizospheres along Living Roots (C3)
- Presence of Reduced Iron (C4)
- Recent Iron Reduction in Tilled Soils (C6)
- Thin Muck Surface (C7)
- Other (Explain in Remarks)

Secondary Indicators (2 or more required)

- Water Marks (B1) (Riverine)
- Sediment Deposits (B2) (Riverine)
- Drift Deposits (B3) (Riverine)
- Drainage Patterns (B10)
- Dry-Season Water Table (C2)
- Crayfish Burrows (C8)
- Saturation Visible on Aerial Imagery (C9)
- Shallow Aquitard (D3)
- FAC-Neutral Test (D5)

Field Observations:

Surface Water Present? Yes No Depth (inches): None
 Water Table Present? Yes No Depth (inches): None
 Saturation Present? (includes capillary fringe) Yes No Depth (inches): None

Wetland Hydrology Present? Yes No

Describe Recorded Data (stream gauge, monitoring well, aerial photos, previous inspections), if available:

None

Remarks:

Located in swale at toe of slope that receives surface (sheet flow, two man-made ditches) and subsurface discharge from slope. Wetland delineated to edge of three parameters, but concave area continues south and the wetland appears to continue to discharge south and east, off study area. No culvert or channelize flow observed, but likely drains via sheet flow toward southeast, off study area, and potentially into offsite creek. Connection to creek not investigated because it is located off the study area.

WETLAND DETERMINATION DATA FORM – Arid West Region

Project/Site: Lakeview Estates (APN 051-411-20) City/County: Watsonville, Santa Cruz Co. Sampling Date: 5/22/18
 Applicant/Owner: Raeid Farhat State: CA Sampling Point: 6b
 Investigator(s): T. Mahony, Coast Range Biological LLC Section, Township, Range: Mt. Diablo Meridian, T11S,R2E,sec21
 Landform (hillslope, terrace, etc.): slope Local relief (concave, convex, none): convex Slope (%): 10
 Subregion (LRR): Mediterranean CA (LRR C) Lat: 36.957259 Long: -121.759404 Datum: NAD 83
 Soil Map Unit Name: Pinto loam, 9 to 15 percent slopes NWI classification: None

Are climatic / hydrologic conditions on the site typical for this time of year? Yes No (If no, explain in Remarks.)
 Are Vegetation , Soil , or Hydrology significantly disturbed? Are "Normal Circumstances" present? Yes No
 Are Vegetation , Soil , or Hydrology naturally problematic? (If needed, explain any answers in Remarks.)

SUMMARY OF FINDINGS – Attach site map showing sampling point locations, transects, important features, etc.

Hydrophytic Vegetation Present? Yes <input type="checkbox"/> No <input checked="" type="checkbox"/> Hydric Soil Present? Yes <input type="checkbox"/> No <input checked="" type="checkbox"/> Wetland Hydrology Present? Yes <input type="checkbox"/> No <input checked="" type="checkbox"/>	Is the Sampled Area within a Wetland? Yes <input type="checkbox"/> No <input checked="" type="checkbox"/>
Remarks: Seasonal hydrology naturally problematic. No wetland indicators observed. Sample point located in upland.	

VEGETATION – Use scientific names of plants.

Tree Stratum (Plot size: <u>10'</u>)	Absolute % Cover	Dominant Species?	Indicator Status	Dominance Test worksheet:
1. _____	_____	_____	_____	Number of Dominant Species That Are OBL, FACW, or FAC: <u>1</u> (A)
2. _____	_____	_____	_____	Total Number of Dominant Species Across All Strata: <u>2</u> (B)
3. _____	_____	_____	_____	Percent of Dominant Species That Are OBL, FACW, or FAC: <u>50</u> (A/B)
4. _____	_____	_____	_____	
= Total Cover				
Sapling/Shrub Stratum (Plot size: <u>5'</u>)	Absolute % Cover	Dominant Species?	Indicator Status	Prevalence Index worksheet:
1. <u>Rubus ursinus</u>	<u>65</u>	<u>Y</u>	<u>FAC</u>	Total % Cover of: _____ Multiply by: _____
2. _____	_____	_____	_____	OBL species _____ x 1 = _____
3. _____	_____	_____	_____	FACW species _____ x 2 = _____
4. _____	_____	_____	_____	FAC species <u>70</u> x 3 = <u>210</u>
5. _____	_____	_____	_____	FACU species <u>5</u> x 4 = <u>20</u>
<u>65</u> = Total Cover				UPL species <u>30</u> x 5 = <u>150</u>
				Column Totals: <u>105</u> (A) <u>380</u> (B)
				Prevalence Index = B/A = <u>3.6</u>
Herb Stratum (Plot size: <u>5'</u>)	Absolute % Cover	Dominant Species?	Indicator Status	Hydrophytic Vegetation Indicators:
1. <u>Carduus pycnocephalus</u>	<u>25</u>	<u>Y</u>	<u>UPL</u>	<input type="checkbox"/> Dominance Test is >50%
2. <u>Bromus hordeaceus</u>	<u>5</u>	<u>N</u>	<u>FACU</u>	<input type="checkbox"/> Prevalence Index is ≤3.0 ¹
3. <u>Rumex crispus</u>	<u>5</u>	<u>N</u>	<u>FAC</u>	<input type="checkbox"/> Morphological Adaptations ¹ (Provide supporting data in Remarks or on a separate sheet)
4. <u>Geranium dissectum</u>	<u>5</u>	<u>N</u>	<u>UPL</u>	<input type="checkbox"/> Problematic Hydrophytic Vegetation ¹ (Explain)
5. _____	_____	_____	_____	
6. _____	_____	_____	_____	
7. _____	_____	_____	_____	
8. _____	_____	_____	_____	
<u>40</u> = Total Cover				
Woody Vine Stratum (Plot size: <u>5'</u>)	Absolute % Cover	Dominant Species?	Indicator Status	
1. _____	_____	_____	_____	
2. _____	_____	_____	_____	
= Total Cover				
% Bare Ground in Herb Stratum <u>1</u> % Cover of Biotic Crust _____				¹ Indicators of hydric soil and wetland hydrology must be present, unless disturbed or problematic.
				Hydrophytic Vegetation Present? Yes <input type="checkbox"/> No <input checked="" type="checkbox"/>

Remarks:
 Sample point dominated by a mix of wetland and upland vegetation. Dense area of blackberry could be indicative of elevated near-surface soil moisture, but surface and near-surface wetland hydrology indicators lacking.

SOIL

Sampling Point: 6b

Profile Description: (Describe to the depth needed to document the indicator or confirm the absence of indicators.)

Depth (inches)	Matrix		Redox Features				Texture	Remarks
	Color (moist)	%	Color (moist)	%	Type ¹	Loc ²		
0-8	10YR 2/2	99+	10YR 5/6	<1	C	M	loam	
8-16	10YR 2/2	99+	10YR 5/6	<1	C	M	clay loam	

¹Type: C=Concentration, D=Depletion, RM=Reduced Matrix, CS=Covered or Coated Sand Grains. ²Location: PL=Pore Lining, M=Matrix.

Hydric Soil Indicators: (Applicable to all LRRs, unless otherwise noted.)

- Histosol (A1)
- Histic Epipedon (A2)
- Black Histic (A3)
- Hydrogen Sulfide (A4)
- Stratified Layers (A5) (LRR C)
- 1 cm Muck (A9) (LRR D)
- Depleted Below Dark Surface (A11)
- Thick Dark Surface (A12)
- Sandy Mucky Mineral (S1)
- Sandy Gleyed Matrix (S4)

- Sandy Redox (S5)
- Stripped Matrix (S6)
- Loamy Mucky Mineral (F1)
- Loamy Gleyed Matrix (F2)
- Depleted Matrix (F3)
- Redox Dark Surface (F6)
- Depleted Dark Surface (F7)
- Redox Depressions (F8)
- ~~Vernal Pools (F9)~~

Indicators for Problematic Hydric Soils³:

- 1 cm Muck (A9) (LRR C)
- 2 cm Muck (A10) (LRR B)
- Reduced Vertic (F18)
- Red Parent Material (TF2)
- Other (Explain in Remarks)

³Indicators of hydrophytic vegetation and wetland hydrology must be present, unless disturbed or problematic.

Restrictive Layer (if present):

Type: none
 Depth (inches): _____

Hydric Soil Present? Yes _____ No

Remarks:

Faint redox present, but insufficient to meet hydric indicators.

HYDROLOGY

Wetland Hydrology Indicators:

Primary Indicators (minimum of one required; check all that apply)

- Surface Water (A1)
- High Water Table (A2)
- Saturation (A3)
- Water Marks (B1) (Nonriverine)
- Sediment Deposits (B2) (Nonriverine)
- Drift Deposits (B3) (Nonriverine)
- Surface Soil Cracks (B6)
- Inundation Visible on Aerial Imagery (B7)
- Water-Stained Leaves (B9)

- Salt Crust (B11)
- Biotic Crust (B12)
- Aquatic Invertebrates (B13)
- Hydrogen Sulfide Odor (C1)
- Oxidized Rhizospheres along Living Roots (C3)
- Presence of Reduced Iron (C4)
- Recent Iron Reduction in Tilled Soils (C6)
- Thin Muck Surface (C7)
- Other (Explain in Remarks)

Secondary Indicators (2 or more required)

- Water Marks (B1) (Riverine)
- Sediment Deposits (B2) (Riverine)
- Drift Deposits (B3) (Riverine)
- Drainage Patterns (B10)
- Dry-Season Water Table (C2)
- Crayfish Burrows (C8)
- Saturation Visible on Aerial Imagery (C9)
- Shallow Aquitard (D3)
- FAC-Neutral Test (D5)

Field Observations:

Surface Water Present? Yes _____ No Depth (inches): None
 Water Table Present? Yes _____ No Depth (inches): None
 Saturation Present? (includes capillary fringe) Yes _____ No Depth (inches): None

Wetland Hydrology Present? Yes _____ No

Describe Recorded Data (stream gauge, monitoring well, aerial photos, previous inspections), if available:

None

Remarks:

No wetland hydrology indicators observed. Located on slope above swale, transitional area that likely receives elevated soil moisture but insufficient (perhaps due to lack of near-surface restricting layer) to produce wetland hydrology.

WETLAND DETERMINATION DATA FORM – Arid West Region

Project/Site: Lakeview Estates (APN 051-411-20) City/County: Watsonville, Santa Cruz Co. Sampling Date: 5/22/18
 Applicant/Owner: Raeid Farhat State: CA Sampling Point: 7
 Investigator(s): T. Mahony, Coast Range Biological LLC Section, Township, Range: Mt. Diablo Meridian, T11S,R2E,sec21
 Landform (hillslope, terrace, etc.): basin Local relief (concave, convex, none): concave Slope (%): 2
 Subregion (LRR): Mediterranean CA (LRR C) Lat: 36.956675 Long: -121.759230 Datum: NAD 83
 Soil Map Unit Name: Pinto loam, 9 to 15 percent slopes NWI classification: None

Are climatic / hydrologic conditions on the site typical for this time of year? Yes No (If no, explain in Remarks.)
 Are Vegetation , Soil , or Hydrology significantly disturbed? Are "Normal Circumstances" present? Yes No
 Are Vegetation , Soil , or Hydrology naturally problematic? (If needed, explain any answers in Remarks.)

SUMMARY OF FINDINGS – Attach site map showing sampling point locations, transects, important features, etc.

Hydrophytic Vegetation Present? Yes <input checked="" type="checkbox"/> No <input type="checkbox"/> Hydric Soil Present? Yes <input type="checkbox"/> No <input checked="" type="checkbox"/> Wetland Hydrology Present? Yes <input type="checkbox"/> No <input checked="" type="checkbox"/>	Is the Sampled Area within a Wetland? Yes <input type="checkbox"/> No <input checked="" type="checkbox"/>
Remarks: Seasonal hydrology naturally problematic. Dense area of blackberry that likely receives abundant near-surface moisture, but insufficient for wetland hydrology. Only one wetland indicator observed. Sample point located in upland.	

VEGETATION – Use scientific names of plants.

Tree Stratum (Plot size: <u>10'</u>)	Absolute % Cover	Dominant Species?	Indicator Status	
1. _____	_____	_____	_____	Dominance Test worksheet: Number of Dominant Species That Are OBL, FACW, or FAC: <u>1</u> (A) Total Number of Dominant Species Across All Strata: <u>1</u> (B) Percent of Dominant Species That Are OBL, FACW, or FAC: <u>100</u> (A/B)
2. _____	_____	_____	_____	
3. _____	_____	_____	_____	
4. _____	_____	_____	_____	
= Total Cover				Prevalence Index worksheet: Total % Cover of: _____ Multiply by: OBL species _____ x 1 = _____ FACW species _____ x 2 = _____ FAC species _____ x 3 = _____ FACU species _____ x 4 = _____ UPL species _____ x 5 = _____ Column Totals: _____ (A) _____ (B) Prevalence Index = B/A = _____
Sapling/Shrub Stratum (Plot size: <u>5'</u>)				
1. <u>Rubus ursinus</u>	<u>85</u>	<u>Y</u>	<u>FAC</u>	
2. <u>Quercus agrifolia</u>	<u>5</u>	<u>N</u>	<u>UPL</u>	
3. _____	_____	_____	_____	
4. _____	_____	_____	_____	
5. _____	_____	_____	_____	
<u>90</u> = Total Cover				
Herb Stratum (Plot size: <u>5'</u>)				
1. <u>Cirsium vulgare</u>	<u>5</u>	<u>N</u>	<u>UPL</u>	
2. <u>Artemisia douglasiana</u>	<u>5</u>	<u>N</u>	<u>FAC</u>	
3. <u>Lysimachia arvensis</u>	<u>5</u>	<u>N</u>	<u>FAC</u>	
4. <u>Sonchus asper</u>	<u>5</u>	<u>N</u>	<u>FAC</u>	
5. _____	_____	_____	_____	
6. _____	_____	_____	_____	
7. _____	_____	_____	_____	
8. _____	_____	_____	_____	
<u>20</u> = Total Cover				
Woody Vine Stratum (Plot size: <u>5'</u>)				
1. _____	_____	_____	_____	
2. _____	_____	_____	_____	
_____ = Total Cover				
% Bare Ground in Herb Stratum <u>1</u> % Cover of Biotic Crust _____				
Remarks: Sample point dominated by dense area of blackberry that could be indicative of near-surface soil moisture, but surface and near-surface wetland hydrology indicators lacking.				

Hydrophytic Vegetation Present? Yes No

SOIL

Sampling Point: 7

Profile Description: (Describe to the depth needed to document the indicator or confirm the absence of indicators.)

Depth (inches)	Matrix		Redox Features				Texture	Remarks
	Color (moist)	%	Color (moist)	%	Type ¹	Loc ²		
0-6	10YR 2/2	100	none				loam	
6-16	10YR 3/2	99+	10YR 4/6	<1	C	M	clay loam	

¹Type: C=Concentration, D=Depletion, RM=Reduced Matrix, CS=Covered or Coated Sand Grains. ²Location: PL=Pore Lining, M=Matrix.

Hydric Soil Indicators: (Applicable to all LRRs, unless otherwise noted.)		Indicators for Problematic Hydric Soils ³ :
<input type="checkbox"/> Histosol (A1)	<input type="checkbox"/> Sandy Redox (S5)	<input type="checkbox"/> 1 cm Muck (A9) (LRR C)
<input type="checkbox"/> Histic Epipedon (A2)	<input type="checkbox"/> Stripped Matrix (S6)	<input type="checkbox"/> 2 cm Muck (A10) (LRR B)
<input type="checkbox"/> Black Histic (A3)	<input type="checkbox"/> Loamy Mucky Mineral (F1)	<input type="checkbox"/> Reduced Vertic (F18)
<input type="checkbox"/> Hydrogen Sulfide (A4)	<input type="checkbox"/> Loamy Gleyed Matrix (F2)	<input type="checkbox"/> Red Parent Material (TF2)
<input type="checkbox"/> Stratified Layers (A5) (LRR C)	<input type="checkbox"/> Depleted Matrix (F3)	<input type="checkbox"/> Other (Explain in Remarks)
<input type="checkbox"/> 1 cm Muck (A9) (LRR D)	<input type="checkbox"/> Redox Dark Surface (F6)	
<input type="checkbox"/> Depleted Below Dark Surface (A11)	<input type="checkbox"/> Depleted Dark Surface (F7)	
<input type="checkbox"/> Thick Dark Surface (A12)	<input type="checkbox"/> Redox Depressions (F8)	
<input type="checkbox"/> Sandy Mucky Mineral (S1)	<input type="checkbox"/> Vernal Pools (F9)	
<input type="checkbox"/> Sandy Gleyed Matrix (S4)		

³Indicators of hydrophytic vegetation and wetland hydrology must be present, unless disturbed or problematic.

Restrictive Layer (if present):
 Type: none
 Depth (inches): _____

Hydric Soil Present? Yes _____ No

Remarks:
 Faint redox present, but insufficient to meet hydric soil indicators.

HYDROLOGY

Wetland Hydrology Indicators:	
Primary Indicators (minimum of one required; check all that apply)	Secondary Indicators (2 or more required)
<input type="checkbox"/> Surface Water (A1)	<input type="checkbox"/> Salt Crust (B11)
<input type="checkbox"/> High Water Table (A2)	<input type="checkbox"/> Biotic Crust (B12)
<input type="checkbox"/> Saturation (A3)	<input type="checkbox"/> Aquatic Invertebrates (B13)
<input type="checkbox"/> Water Marks (B1) (Nonriverine)	<input type="checkbox"/> Hydrogen Sulfide Odor (C1)
<input type="checkbox"/> Sediment Deposits (B2) (Nonriverine)	<input type="checkbox"/> Oxidized Rhizospheres along Living Roots (C3)
<input type="checkbox"/> Drift Deposits (B3) (Nonriverine)	<input type="checkbox"/> Presence of Reduced Iron (C4)
<input type="checkbox"/> Surface Soil Cracks (B6)	<input type="checkbox"/> Recent Iron Reduction in Tilled Soils (C6)
<input type="checkbox"/> Inundation Visible on Aerial Imagery (B7)	<input type="checkbox"/> Thin Muck Surface (C7)
<input type="checkbox"/> Water-Stained Leaves (B9)	<input type="checkbox"/> Other (Explain in Remarks)
<input type="checkbox"/> Water Marks (B1) (Riverine)	<input type="checkbox"/> Sediment Deposits (B2) (Riverine)
<input type="checkbox"/> Drift Deposits (B3) (Riverine)	<input type="checkbox"/> Drainage Patterns (B10)
<input type="checkbox"/> Dry-Season Water Table (C2)	<input type="checkbox"/> Crayfish Burrows (C8)
<input type="checkbox"/> Saturation Visible on Aerial Imagery (C9)	<input type="checkbox"/> Shallow Aquitard (D3)
<input type="checkbox"/> FAC-Neutral Test (D5)	

Field Observations:
 Surface Water Present? Yes _____ No Depth (inches): None
 Water Table Present? Yes _____ No Depth (inches): None
 Saturation Present? (includes capillary fringe) Yes _____ No Depth (inches): None

Wetland Hydrology Present? Yes _____ No

Describe Recorded Data (stream gauge, monitoring well, aerial photos, previous inspections), if available:
 None

Remarks:
 No wetland hydrology indicators observed, but due to topographic position and dense blackberry, likely receives abundant soil moisture. However (perhaps due to lack of restricting layer) no evidence of surface ponding or extensive near-surface saturation observed. Likely conveys sheet flow from Wetland 2 toward creek.

WETLAND DETERMINATION DATA FORM – Arid West Region

Project/Site: Lakeview Estates (APN 051-411-20) City/County: Watsonville, Santa Cruz Co. Sampling Date: 5/22/18
 Applicant/Owner: Raeid Farhat State: CA Sampling Point: 8
 Investigator(s): T. Mahony, Coast Range Biological LLC Section, Township, Range: Mt. Diablo Meridian, T11S,R2E,sec21
 Landform (hillslope, terrace, etc.): field Local relief (concave, convex, none): none Slope (%): 1
 Subregion (LRR): Mediterranean CA (LRR C) Lat: 36.957035 Long: -121.759960 Datum: NAD 83
 Soil Map Unit Name: Pinto loam, 9 to 15 percent slopes NWI classification: None

Are climatic / hydrologic conditions on the site typical for this time of year? Yes No (If no, explain in Remarks.)
 Are Vegetation , Soil , or Hydrology significantly disturbed? Are "Normal Circumstances" present? Yes No
 Are Vegetation , Soil , or Hydrology naturally problematic? (If needed, explain any answers in Remarks.)

SUMMARY OF FINDINGS – Attach site map showing sampling point locations, transects, important features, etc.

Hydrophytic Vegetation Present? Yes <input type="checkbox"/> No <input checked="" type="checkbox"/> Hydric Soil Present? Yes <input type="checkbox"/> No <input checked="" type="checkbox"/> Wetland Hydrology Present? Yes <input type="checkbox"/> No <input checked="" type="checkbox"/>	Is the Sampled Area within a Wetland? Yes <input type="checkbox"/> No <input checked="" type="checkbox"/>
Remarks: Seasonal hydrology naturally problematic. Located in compacted area disturbed from vehicles and/or grading. No wetland indicators observed. Sample point located in upland.	

VEGETATION – Use scientific names of plants.

Tree Stratum (Plot size: <u>10'</u>)	Absolute % Cover	Dominant Species?	Indicator Status	Dominance Test worksheet:
1. _____	_____	_____	_____	Number of Dominant Species That Are OBL, FACW, or FAC: <u>1</u> (A)
2. _____	_____	_____	_____	Total Number of Dominant Species Across All Strata: <u>2</u> (B)
3. _____	_____	_____	_____	Percent of Dominant Species That Are OBL, FACW, or FAC: <u>50</u> (A/B)
4. _____	_____	_____	_____	
= Total Cover				
Sapling/Shrub Stratum (Plot size: <u>5'</u>)	Absolute % Cover	Dominant Species?	Indicator Status	Prevalence Index worksheet:
1. _____	_____	_____	_____	Total % Cover of: _____ Multiply by: _____
2. _____	_____	_____	_____	OBL species _____ x 1 = _____
3. _____	_____	_____	_____	FACW species _____ x 2 = _____
4. _____	_____	_____	_____	FAC species <u>40</u> x 3 = <u>120</u>
5. _____	_____	_____	_____	FACU species <u>40</u> x 4 = <u>160</u>
= Total Cover				UPL species <u>15</u> x 5 = <u>75</u>
				Column Totals: <u>95</u> (A) <u>355</u> (B)
				Prevalence Index = B/A = <u>3.74</u>
Herb Stratum (Plot size: <u>5'</u>)	Absolute % Cover	Dominant Species?	Indicator Status	Hydrophytic Vegetation Indicators:
1. <u>Avena barbata</u>	<u>5</u>	<u>N</u>	<u>UPL</u>	<input type="checkbox"/> Dominance Test is >50%
2. <u>Bromus diandrus</u>	<u>5</u>	<u>N</u>	<u>UPL</u>	<input type="checkbox"/> Prevalence Index is ≤3.0 ¹
3. <u>Vicia sativa</u>	<u>10</u>	<u>N</u>	<u>FACU</u>	<input type="checkbox"/> Morphological Adaptations ¹ (Provide supporting data in Remarks or on a separate sheet)
4. <u>Plantago lanceolata</u>	<u>40</u>	<u>Y</u>	<u>FAC</u>	<input type="checkbox"/> Problematic Hydrophytic Vegetation ¹ (Explain)
5. <u>Festuca myuros</u>	<u>30</u>	<u>Y</u>	<u>FACU</u>	
6. <u>Eschscholzia californica</u>	<u>5</u>	<u>N</u>	<u>UPL</u>	
7. _____	_____	_____	_____	
8. _____	_____	_____	_____	
= Total Cover				
Woody Vine Stratum (Plot size: <u>5'</u>)	Absolute % Cover	Dominant Species?	Indicator Status	Hydrophytic Vegetation Present?
1. _____	_____	_____	_____	Yes <input type="checkbox"/> No <input checked="" type="checkbox"/>
2. _____	_____	_____	_____	
= Total Cover				
% Bare Ground in Herb Stratum <u>10</u> % Cover of Biotic Crust _____				

Remarks:
 Sample point not dominated by hydrophytic vegetation.

SOIL

Sampling Point: 8

Profile Description: (Describe to the depth needed to document the indicator or confirm the absence of indicators.)

Depth (inches)	Matrix		Redox Features				Texture	Remarks
	Color (moist)	%	Color (moist)	%	Type ¹	Loc ²		
0-10	10YR 2/2	100	none				clay loam	

¹Type: C=Concentration, D=Depletion, RM=Reduced Matrix, CS=Covered or Coated Sand Grains. ²Location: PL=Pore Lining, M=Matrix.

Hydric Soil Indicators: (Applicable to all LRRs, unless otherwise noted.)

- Histosol (A1)
- Histic Epipedon (A2)
- Black Histic (A3)
- Hydrogen Sulfide (A4)
- Stratified Layers (A5) (LRR C)
- 1 cm Muck (A9) (LRR D)
- Depleted Below Dark Surface (A11)
- Thick Dark Surface (A12)
- Sandy Mucky Mineral (S1)
- Sandy Gleyed Matrix (S4)

- Sandy Redox (S5)
- Stripped Matrix (S6)
- Loamy Mucky Mineral (F1)
- Loamy Gleyed Matrix (F2)
- Depleted Matrix (F3)
- Redox Dark Surface (F6)
- Depleted Dark Surface (F7)
- Redox Depressions (F8)
- ~~Vernal Pools (F9)~~

Indicators for Problematic Hydric Soils³:

- 1 cm Muck (A9) (LRR C)
- 2 cm Muck (A10) (LRR B)
- Reduced Vertic (F18)
- Red Parent Material (TF2)
- Other (Explain in Remarks)

³Indicators of hydrophytic vegetation and wetland hydrology must be present, unless disturbed or problematic.

Restrictive Layer (if present):

Type: compacted soil hardpan
 Depth (inches): 10"

Hydric Soil Present? Yes No

Remarks:

No hydric indicators observed.

HYDROLOGY

Wetland Hydrology Indicators:

Primary Indicators (minimum of one required; check all that apply)

- Surface Water (A1)
- High Water Table (A2)
- Saturation (A3)
- Water Marks (B1) (Nonriverine)
- Sediment Deposits (B2) (Nonriverine)
- Drift Deposits (B3) (Nonriverine)
- Surface Soil Cracks (B6)
- Inundation Visible on Aerial Imagery (B7)
- Water-Stained Leaves (B9)

- Salt Crust (B11)
- Biotic Crust (B12)
- Aquatic Invertebrates (B13)
- Hydrogen Sulfide Odor (C1)
- Oxidized Rhizospheres along Living Roots (C3)
- Presence of Reduced Iron (C4)
- Recent Iron Reduction in Tilled Soils (C6)
- Thin Muck Surface (C7)
- Other (Explain in Remarks)

Secondary Indicators (2 or more required)

- Water Marks (B1) (Riverine)
- Sediment Deposits (B2) (Riverine)
- Drift Deposits (B3) (Riverine)
- Drainage Patterns (B10)
- Dry-Season Water Table (C2)
- Crayfish Burrows (C8)
- Saturation Visible on Aerial Imagery (C9)
- Shallow Aquitard (D3)
- FAC-Neutral Test (D5)

Field Observations:

Surface Water Present? Yes No Depth (inches): None
 Water Table Present? Yes No Depth (inches): None
 Saturation Present? (includes capillary fringe) Yes No Depth (inches): None

Wetland Hydrology Present? Yes No

Describe Recorded Data (stream gauge, monitoring well, aerial photos, previous inspections), if available:

None

Remarks:

No wetland hydrology indicators observed. One structural secondary wetland hydrology indicator present due to compacted soils, but no evidence of ponding observed.

WETLAND DETERMINATION DATA FORM – Arid West Region

Project/Site: Lakeview Estates (APN 051-411-20) City/County: Watsonville, Santa Cruz Co. Sampling Date: 5/22/18
 Applicant/Owner: Raeid Farhat State: CA Sampling Point: 9
 Investigator(s): T. Mahony, Coast Range Biological LLC Section, Township, Range: Mt. Diablo Meridian, T11S,R2E,sec21
 Landform (hillslope, terrace, etc.): field Local relief (concave, convex, none): none Slope (%): 1
 Subregion (LRR): Mediterranean CA (LRR C) Lat: 36.957226 Long: -121.760147 Datum: NAD 83
 Soil Map Unit Name: Watsonville loam, 2 to 15 percent slopes NWI classification: None

Are climatic / hydrologic conditions on the site typical for this time of year? Yes No (If no, explain in Remarks.)
 Are Vegetation , Soil , or Hydrology significantly disturbed? Are "Normal Circumstances" present? Yes No
 Are Vegetation , Soil , or Hydrology naturally problematic? (If needed, explain any answers in Remarks.)

SUMMARY OF FINDINGS – Attach site map showing sampling point locations, transects, important features, etc.

Hydrophytic Vegetation Present? Yes <input type="checkbox"/> No <input checked="" type="checkbox"/> Hydric Soil Present? Yes <input type="checkbox"/> No <input checked="" type="checkbox"/> Wetland Hydrology Present? Yes <input type="checkbox"/> No <input checked="" type="checkbox"/>	Is the Sampled Area within a Wetland? Yes <input type="checkbox"/> No <input checked="" type="checkbox"/>
Remarks: Seasonal hydrology naturally problematic. Located in disturbed compacted area from vehicles and/or grading. No wetland indicators observed. Sample point located in upland.	

VEGETATION – Use scientific names of plants.

Tree Stratum (Plot size: <u>10'</u>)	Absolute % Cover	Dominant Species?	Indicator Status	Dominance Test worksheet:
1. _____	_____	_____	_____	Number of Dominant Species That Are OBL, FACW, or FAC: <u>1</u> (A)
2. _____	_____	_____	_____	Total Number of Dominant Species Across All Strata: <u>3</u> (B)
3. _____	_____	_____	_____	Percent of Dominant Species That Are OBL, FACW, or FAC: <u>33</u> (A/B)
4. _____	_____	_____	_____	
_____ = Total Cover				
Sapling/Shrub Stratum (Plot size: <u>5'</u>)	Absolute % Cover	Dominant Species?	Indicator Status	Prevalence Index worksheet:
1. _____	_____	_____	_____	Total % Cover of: _____ Multiply by: _____
2. _____	_____	_____	_____	OBL species _____ x 1 = _____
3. _____	_____	_____	_____	FACW species _____ x 2 = _____
4. _____	_____	_____	_____	FAC species <u>45</u> x 3 = <u>135</u>
5. _____	_____	_____	_____	FACU species <u>50</u> x 4 = <u>200</u>
_____ = Total Cover				UPL species <u>10</u> x 5 = <u>50</u>
				Column Totals: <u>105</u> (A) <u>385</u> (B)
				Prevalence Index = B/A = <u>3.67</u>
Herb Stratum (Plot size: <u>5'</u>)	Absolute % Cover	Dominant Species?	Indicator Status	Hydrophytic Vegetation Indicators:
1. <u>Avena barbata</u>	<u>5</u>	<u>N</u>	<u>UPL</u>	<input type="checkbox"/> Dominance Test is >50%
2. <u>Bromus diandrus</u>	<u>5</u>	<u>N</u>	<u>UPL</u>	<input type="checkbox"/> Prevalence Index is ≤3.0 ¹
3. <u>Vicia sativa</u>	<u>25</u>	<u>Y</u>	<u>FACU</u>	<input type="checkbox"/> Morphological Adaptations ¹ (Provide supporting data in Remarks or on a separate sheet)
4. <u>Plantago lanceolata</u>	<u>40</u>	<u>Y</u>	<u>FAC</u>	<input type="checkbox"/> Problematic Hydrophytic Vegetation ¹ (Explain)
5. <u>Festuca myuros</u>	<u>25</u>	<u>Y</u>	<u>FACU</u>	
6. <u>Festuca perennis</u>	<u>5</u>	<u>N</u>	<u>FAC</u>	
7. _____	_____	_____	_____	
8. _____	_____	_____	_____	
<u>105</u> = Total Cover				
Woody Vine Stratum (Plot size: <u>5'</u>)	Absolute % Cover	Dominant Species?	Indicator Status	Hydrophytic Vegetation Present?
1. _____	_____	_____	_____	Yes <input type="checkbox"/> No <input checked="" type="checkbox"/>
2. _____	_____	_____	_____	
_____ = Total Cover				
% Bare Ground in Herb Stratum <u>5</u> % Cover of Biotic Crust _____				

Remarks:
 Sample point not dominated by hydrophytic vegetation.

SOIL

Sampling Point: 9

Profile Description: (Describe to the depth needed to document the indicator or confirm the absence of indicators.)

Depth (inches)	Matrix		Redox Features				Texture	Remarks
	Color (moist)	%	Color (moist)	%	Type ¹	Loc ²		
0-5	10YR 2/2	100	none				loam	
5-16	10YR 2/2	99+	10YR 5/4	<1	C	M	clay loam	

¹Type: C=Concentration, D=Depletion, RM=Reduced Matrix, CS=Covered or Coated Sand Grains. ²Location: PL=Pore Lining, M=Matrix.

Hydric Soil Indicators: (Applicable to all LRRs, unless otherwise noted.)

- Histosol (A1)
- Histic Epipedon (A2)
- Black Histic (A3)
- Hydrogen Sulfide (A4)
- Stratified Layers (A5) (LRR C)
- 1 cm Muck (A9) (LRR D)
- Depleted Below Dark Surface (A11)
- Thick Dark Surface (A12)
- Sandy Mucky Mineral (S1)
- Sandy Gleyed Matrix (S4)

- Sandy Redox (S5)
- Stripped Matrix (S6)
- Loamy Mucky Mineral (F1)
- Loamy Gleyed Matrix (F2)
- Depleted Matrix (F3)
- Redox Dark Surface (F6)
- Depleted Dark Surface (F7)
- Redox Depressions (F8)
- ~~Vernal Pools (F9)~~

Indicators for Problematic Hydric Soils³:

- 1 cm Muck (A9) (LRR C)
- 2 cm Muck (A10) (LRR B)
- Reduced Vertic (F18)
- Red Parent Material (TF2)
- Other (Explain in Remarks)

³Indicators of hydrophytic vegetation and wetland hydrology must be present, unless disturbed or problematic.

Restrictive Layer (if present):

Type: compacted soil hardpan
 Depth (inches): 10"

Hydric Soil Present? Yes No

Remarks:

Faint redox in subsoil, but insufficient to meet hydric soil indicators.

HYDROLOGY

Wetland Hydrology Indicators:

Primary Indicators (minimum of one required; check all that apply)

- Surface Water (A1)
- High Water Table (A2)
- Saturation (A3)
- Water Marks (B1) (Nonriverine)
- Sediment Deposits (B2) (Nonriverine)
- Drift Deposits (B3) (Nonriverine)
- Surface Soil Cracks (B6)
- Inundation Visible on Aerial Imagery (B7)
- Water-Stained Leaves (B9)

- Salt Crust (B11)
- Biotic Crust (B12)
- Aquatic Invertebrates (B13)
- Hydrogen Sulfide Odor (C1)
- Oxidized Rhizospheres along Living Roots (C3)
- Presence of Reduced Iron (C4)
- Recent Iron Reduction in Tilled Soils (C6)
- Thin Muck Surface (C7)
- Other (Explain in Remarks)

Secondary Indicators (2 or more required)

- Water Marks (B1) (Riverine)
- Sediment Deposits (B2) (Riverine)
- Drift Deposits (B3) (Riverine)
- Drainage Patterns (B10)
- Dry-Season Water Table (C2)
- Crayfish Burrows (C8)
- Saturation Visible on Aerial Imagery (C9)
- Shallow Aquitard (D3)
- FAC-Neutral Test (D5)

Field Observations:

Surface Water Present? Yes No Depth (inches): None
 Water Table Present? Yes No Depth (inches): None
 Saturation Present? (includes capillary fringe) Yes No Depth (inches): None

Wetland Hydrology Present? Yes No

Describe Recorded Data (stream gauge, monitoring well, aerial photos, previous inspections), if available:

None

Remarks:

No wetland hydrology indicators observed.





































SOIL MAP OF THE STUDY AREA

Soil Map—Santa Cruz County, California
(Lakeview_projectsite)



Soil Map—Santa Cruz County, California
(Lakeview_projectsite)

MAP LEGEND

Area of Interest (AOI)	 Area of Interest (AOI)	 Spoil Area
Soils	 Soil Map Unit Polygons	 Stony Spot
	 Soil Map Unit Lines	 Very Stony Spot
	 Soil Map Unit Points	 Wet Spot
Special Point Features	 Blowout	 Other
	 Borrow Pit	 Special Line Features
	 Clay Spot	Water Features
	 Closed Depression	 Streams and Canals
	 Gravel Pit	Transportation
	 Gravelly Spot	 Rails
	 Landfill	 Interstate Highways
	 Lava Flow	 US Routes
	 Marsh or swamp	 Major Roads
	 Mine or Quarry	 Local Roads
	 Miscellaneous Water	Background
	 Perennial Water	 Aerial Photography
	 Rock Outcrop	
	 Saline Spot	
	 Sandy Spot	
	 Severely Eroded Spot	
	 Sinkhole	
	 Slide or Slip	
	 Sodic Spot	

MAP INFORMATION

The soil surveys that comprise your AOI were mapped at 1:24,000.

Warning: Soil Map may not be valid at this scale.
Enlargement of maps beyond the scale of mapping can cause misunderstanding of the detail of mapping and accuracy of soil line placement. The maps do not show the small areas of contrasting soils that could have been shown at a more detailed scale.

Please rely on the bar scale on each map sheet for map measurements.

Source of Map: Natural Resources Conservation Service
Web Soil Survey URL:
Coordinate System: Web Mercator (EPSG:3857)

Maps from the Web Soil Survey are based on the Web Mercator projection, which preserves direction and shape but distorts distance and area. A projection that preserves area, such as the Albers equal-area conic projection, should be used if more accurate calculations of distance or area are required.

This product is generated from the USDA-NRCS certified data as of the version date(s) listed below.

Soil Survey Area: Santa Cruz County, California
Survey Area Data: Version 11, Sep 13, 2017

Soil map units are labeled (as space allows) for map scales 1:50,000 or larger.

Date(s) aerial images were photographed: Dec 31, 2009—Mar 16, 2017

The orthophoto or other base map on which the soil lines were compiled and digitized probably differs from the background imagery displayed on these maps. As a result, some minor shifting of map unit boundaries may be evident.

Map Unit Legend

Map Unit Symbol	Map Unit Name	Acres in AOI	Percent of AOI
163	Pinto loam, 9 to 15 percent slopes	1.6	72.5%
177	Watsonville loam, 2 to 15 percent slopes	0.6	27.5%
Totals for Area of Interest		2.3	100.0%

PHOTOGRAPHS OF THE STUDY AREA



Appendix C-1. Wetland 1 dominated by spreading rush at Sample Point 1a.



Appendix C-2. Non-Native Grassland dominated by slender wild oat and other upland species at Sample Point 1b.



Appendix C-3. Wetland 1 dominated by Himalayan blackberry at Sample Point 2a.



Appendix C-4. Man-made drainage ditch lacking an OHWM and positive indicators of all three wetland parameters at Sample Point 3.



Appendix C-5. Wetland 2 in shallow swale at Sample Point 5a.



Appendix C-6. Wetland 2 in shallow swale at Sample Point 6a.



Appendix C-7. Area dominated by California blackberry, but lacking positive indicators of all three wetland parameters, at Sample Point 7.



Appendix C-8. Compacted area from past disturbance at Sample Point 9.

**PLANT SPECIES OBSERVED ON THE STUDY AREA AND
THEIR WETLAND INDICATOR STATUS**

Appendix D. Plant species observed on the study area and their wetland indicator status.

Scientific Name	Common Name	Wetland Indicator Status (Lichvar et al. 2016)
<i>Artemisia douglasiana</i>	mugwort	FAC
<i>Avena barbata</i> *	slender wild oat	UPL
<i>Baccharis pilularis</i>	coyote brush	UPL
<i>Brassica nigra</i> *	black mustard	UPL
<i>Brassica rapa</i> *	field mustard	FACU
<i>Briza minor</i> *	little quaking grass	FAC
<i>Bromus carinatus</i>	California brome	UPL
<i>Bromus catharticus</i> *	rescue grass	UPL
<i>Bromus diandrus</i> *	ripgut brome	UPL
<i>Bromus hordeaceus</i> *	soft chess	FACU
<i>Carduus pycnocephalus</i> *	Italian thistle	UPL
<i>Cirsium vulgare</i> *	bull thistle	FACU
<i>Conium maculatum</i> *	poison hemlock	FACW
<i>Convolvulus arvensis</i> *	field bindweed	UPL
<i>Cortaderia jubata</i> *	pampas grass	FACU
<i>Cyperus eragrostis</i>	tall flatsedge	FACW
<i>Epilobium ciliatum</i>	willow herb	FACW
<i>Erigeron canadensis</i>	horseweed	FACU
<i>Erodium botrys</i> *	filaree	FACU
<i>Erodium cicutarium</i> *	redstem filaree	UPL
<i>Eschscholzia californica</i>	California poppy	UPL
<i>Festuca myuros</i> *	rattail fescue	FACU
<i>Festuca perennis</i> *	Italian ryegrass	FAC
<i>Galium aparine</i>	goose grass	FACU
<i>Geranium dissectum</i> *	cutleaf geranium	UPL
<i>Helminthotheca echioides</i> *	bristly ox-tongue	FAC
<i>Hordeum murinum</i> subsp. <i>leporinum</i> *	barley	FACU
<i>Hypochaeris radicata</i> *	rough cat's-ear	FACU
<i>Juglans</i> sp.	walnut	
<i>Juncus effusus</i>	soft rush	FACW
<i>Juncus patens</i>	spreading rush	FACW
<i>Lactuca serriola</i> *	prickly lettuce	FACU
<i>Lotus corniculatus</i> *	birds-foot trefoil	FAC
<i>Lysimachia arvensis</i> *	scarlet pimpernel	FAC
<i>Malva</i> sp.*	mallow	
<i>Medicago polymorpha</i> *	bur clover	FACU
<i>Mentha pulegium</i> *	pennyroyal	OBL
<i>Oxalis pes-caprae</i> *	Bermuda buttercup	UPL
<i>Persicaria</i> sp.	smartweed	
<i>Phalaris aquatica</i> *	Harding grass	FACU
<i>Pinus</i> sp.*	pine	UPL
<i>Plantago lanceolata</i> *	English plantain	FAC
<i>Polypogon monspeliensis</i> *	rabbitsfoot grass	FACW
<i>Populus</i> sp.	cottonwood	
<i>Quercus agrifolia</i>	coast live oak	UPL
<i>Raphanus sativus</i> *	wild radish	UPL
<i>Rubus armeniacus</i> *	Himalayan blackberry	FAC

Scientific Name	Common Name	Wetland Indicator Status (Lichvar et al. 2016)
<i>Rubus ursinus</i>	California blackberry	FAC
<i>Rumex acetosella</i> *	sheep sorrel	FACU
<i>Rumex crispus</i> *	curly dock	FAC
<i>Rumex pulcher</i> *	fiddle dock	FAC
<i>Salix</i> sp.	willow	FACW
<i>Sonchus asper</i> subsp. <i>asper</i> *	prickly sow thistle	FAC
<i>Symphotrichum chilense</i>	California aster	FAC
<i>Toxicodendron diversilobum</i>	poison oak	FACU
<i>Tragopogon porrifolius</i> *	salsify	UPL
<i>Typha angustifolia</i>	narrow-leaved cattail	OBL
<i>Verbena lasiostachys</i>	western vervain	FAC
<i>Vicia sativa</i> *	vetch	FACU
<i>Vicia villosa</i> *	hairy vetch	UPL
* = non-native species		

Biotic Resources Group

Biotic Assessments ♦ Resource Management ♦ Permitting

July 22, 2019

Raeid Farhat
c/o Charlie Eadie
Eadie Consulting
P.O. Box 1647
Santa Cruz, CA 95061

Re: Trembly Lane Parcel (APN 051-411-20): Wetland Review

Dear Mr. Farhat and Mr. Eadie,

As per your request, I conducted a review of two potential wetland areas on the property located at the terminus of Trembly Lane in the Watsonville Area of Santa Cruz County. The property is located within an unincorporated area of the county, within the Urban Services Line, yet outside the Coastal Zone.

My review consisted of a field survey (August 22, 2018 and January 18, 2019), review of aerial photos and County GIS maps, and a review of *Aquatic Resources Delineation Report, Lakeview Estates APN 051-411-40, Draft*, (Coast Range Biological, LLC, May 2018) (CRB). The review was conducted to document the wetland's potential jurisdiction under US Army Corps of Engineers (USACE) and Regional Water Quality Control Board (RWQCB) regulations and Santa Cruz County Code.

SUMMARY OF FINDINGS

Two areas on the parcel support seasonal wetlands that meet the 3-parameter requirements under USACE guidelines. These two areas would also meet the wetland criteria of the RWQCB and County Code.

Wetland 1 is a seasonal feature located on a hillside, likely associated with subsurface seasonal drainage; this feature does not have a hydrologic nexus to downstream waters and is considered to be an isolated feature. This wetland supports spreading rush (*Juncus patens*), a species typical of seasonal moisture and Himalaya berry (*Rubus ameniacus*), an invasive, non-native plant species that can grow equally in upland and wetland conditions. This wetland has low wetland functions and values. A 30-foot setback, consistent with the County's setback for a seasonal watercourse, is recommended for this feature. The applicant's site plan depicts this setback.

Wetland 2 is located on the lower slope of the parcel, along the western property line. This wetland supports plant species typical of willow riparian woodland (i.e. young willow) and is located in close proximity to the riparian woodland associated with Stream 533, a watercourse with intermittent flow. This wetland has moderate wetland functions and values; the creek is a tributary to College Lake. As Wetland 2 is closely associated with the nearby riparian woodland it is considered to be part of an arroyo under County Code. A 50-foot setback (measured outward from the edge of the riparian/wetland vegetation), consistent with the County's setback for arroyos, is recommended for this feature. The applicant's site plan depicts this setback.

REVIEW OF DELINEATION REPORT

The Aquatic Resource Delineation Report (CRB, 2018) identified areas that could meet wetlands under U.S. Army Corps of Engineers criteria. A potential wetland (identified as Wetland 1),

characterized by spreading rush (*Juncus patens*) (a facultative-wet [FACW] species) and non-native Himalaya berry (*Rubus ameniacus*) (a facultative [FAC] species) that is located on a south-facing hillside, was found to support the three required wetland parameters (i.e., wetland vegetation, wetland soils, and wetland hydrology). My site inspections confirmed that Wetland 1, excluding a recently constructed ditch made for geologic testing purposes, supports the three required wetland parameters, as outlined by CRB.

Another wetland (identified as Wetland 2), characterized by willow (*Salix lasiolepis*) (a facultative-wet [FACW] species) that is located near the western property line, was found to support the three required wetland parameters (i.e., wetland vegetation, wetland soils, and wetland hydrology). My site inspections confirmed that Wetland 2, as mapped by CRB, supports the three required wetland parameters, as outlined by CRB.

POTENTIAL USACE JURISDICTION

Under USACE guidelines, wetland must have a significant nexus to a Traditional Navigable Water (TNW) (i.e., downstream waters) to be a regulated feature under Section 404 of the Clean Water Act. In January 2019 I investigated whether such a nexus was present for Wetland 1 and Wetland 2.

On January 18, 2019 after approximately 11.3 inches of seasonal rainfall and after a 3-day approximately 2.5-inch rainfall event, I conducted a site visit to examine any hydrologic connection between Wetland 1 and downstream waters. Surface water was present in an unnamed stream located west of the parcel. As observed in the field and as evidenced on aerial photos, water in this stream flows to Stream 533 and then ultimately into College Lake. Surface water was also observed in Stream 533 at Paulsen Road (located southeast of the subject parcel). The proximity of these streams to Wetland 1 and Wetland 2 is depicted on Figure 1.

I did not find any hydrologic connection between Wetland 1 and the unnamed stream or Stream 533. No surface flow (i.e., no sheet flow or swale feature) or evidence of significant underflow (i.e., wetland vegetation) was observed between Wetland 1 and either stream. The lower end of the man-made trench (trench constructed for geologic study and mapped as part of Wetland 1 by CRB) was found to support standing water, indicating soil saturation at/near the surface; however, none of this water was moving downslope and connecting to downstream waters. My conclusion is that Wetland 1, located on a south-facing hillside, is an isolated hillside feature. I agree with the findings of CRB that the wetland feature appears to be sustained by subsurface moisture from the surrounding uplands and a heavy clay layer at 6-8-inch depth that likely perches water and contributes to surface or near surface saturation. However, my winter-season observations failed to find any sheet flow, surface flow, or evidence of substantial underflow that would indicate a connection of Wetland 1 to downstream waters (TNW). Pending confirmation by USACE, Wetland 1 is an isolated feature that is currently not regulated by the USACE under Section 404. In 2001 the U.S. Supreme Court issued a decision on the scope of the USACE's Section 404 CWA permitting as it related to isolated waters. Known as the SWANCC decision, the Court found that the USACE does not have the authority over isolated, non-navigable, intrastate waters that are not tributary or adjacent to navigable waters or tributaries. My observations found that Wetland 2 has a hydrological connection to Stream 533, due to its close proximity to the watercourse and adjacent riparian vegetation.

POTENTIAL RWQCB JURISDICTION

Under RWQCB guidelines, isolated wetlands not subject to Section 404 of the Clean Water Act, can be considered Waters of the State. Wetland 1 and 2 would likely be considered Waters of the State, pending confirmation by this agency.

POTENTIAL COUNTY JURISDICTION

Under County Code, all wetlands and riparian corridors are considered Sensitive Habitat. Pending confirmation by the County, Wetland 1 would be an intermittent wetland subject to Chapter 16.32 Sensitive Habitat Protection. This designation prohibits development, yet allows limited uses, such as resource-dependent uses, limited grazing, and existing agriculture. Wetland 2 would meet the criteria of an arroyo. The site is located within the urban services line and has characteristics of an arroyo. The arroyo would be subject to Chapter 16.30, Riparian Corridor and Wetland Protection, wherein a 50-foot setback from the riparian vegetation is required. The site is located outside of the Coastal Zone, so coastal wetland regulations are not applicable to this property.

REVIEW OF PROPOSED PROJECT AND RECOMMENDATIONS

A preliminary site plan has been developed for the property by Thatcher and Thompson, dated 5-28-19. This plan is presented as Figure 3.

Wetland 1. Wetland 1 is an isolated hillside wetland feature. The wetland supports native spreading rush, a species notated by USACE as FACW. FACW species are found in wetlands 75% of the time. The majority of Wetland 1 supports non-native Himalaya berry. Himalaya berry is an invasive, non-native plant species that is notated as FAC. FAC species are found equally in wetland and upland areas. The species is also opportunist, rapidly colonizes areas where it forms dense thickets and often crowds out native species. Himalaya berry is attractive to upland birds for forage; however, overall, the hillside wetland feature does not provide many typical wetland functions or values. The small hillside feature does not provide any flood flow retention, little pollutant retention value, and little sediment retention value. Its primary value is that it supports a small patch of native plants (spreading rush) amid an otherwise non-native plant landscape.

It is recommended that the hillside wetland feature, excluding the recently constructed geologic testing ditch, be retained on site. Due to its low wetland value and function; a buffer typical to other seasonal features is recommended. The County-defined buffer for intermittent streams (i.e., 30 feet) would be appropriate for this site. The proposed site plan depicts a 30-foot buffer for this feature (see Figure 3).

Wetland 2. Wetland 2 has a hydrologic connection to Stream 533 and is part of a larger riparian woodland/arroyo associated with this stream. The mapped wetland supports native willow, typical to the region and to riparian woodland on adjacent parcels. The wetland/riparian feature does not provide any flood flow retention, yet may provide some hillside pollutant retention and sediment retention. Its primary value is that the riparian woodland vegetation provides habitat connectivity to adjacent parcels and on-site habitat values.

It is recommended that this wetland/riparian feature be retained on site. The County-defined buffer for an arroyo (i.e., 50 feet) would be appropriate for this site. The proposed site plan depicts a 50-foot buffer for this feature (see Figure 3).

Please let me know if you have any questions on this review.

Sincerely



Kathleen Lyons
Plant Ecologist



February 11, 2019

- | | | | | |
|------------------|---------------|------------------|----------------|-------------|
| Streets | -- Driveway | -- Ramp | -- Unnamed | — PERENNIAL |
| --- Alley | -- Levee | -- State Highway | Streams | |
| — Business Route | -- Major Road | -- Street | — INTERMITTENT | |

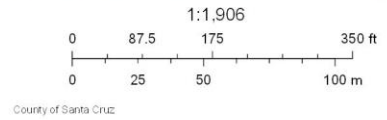

Figure 1. Hydrologic Features Near Wetland 1 and Wetland 2

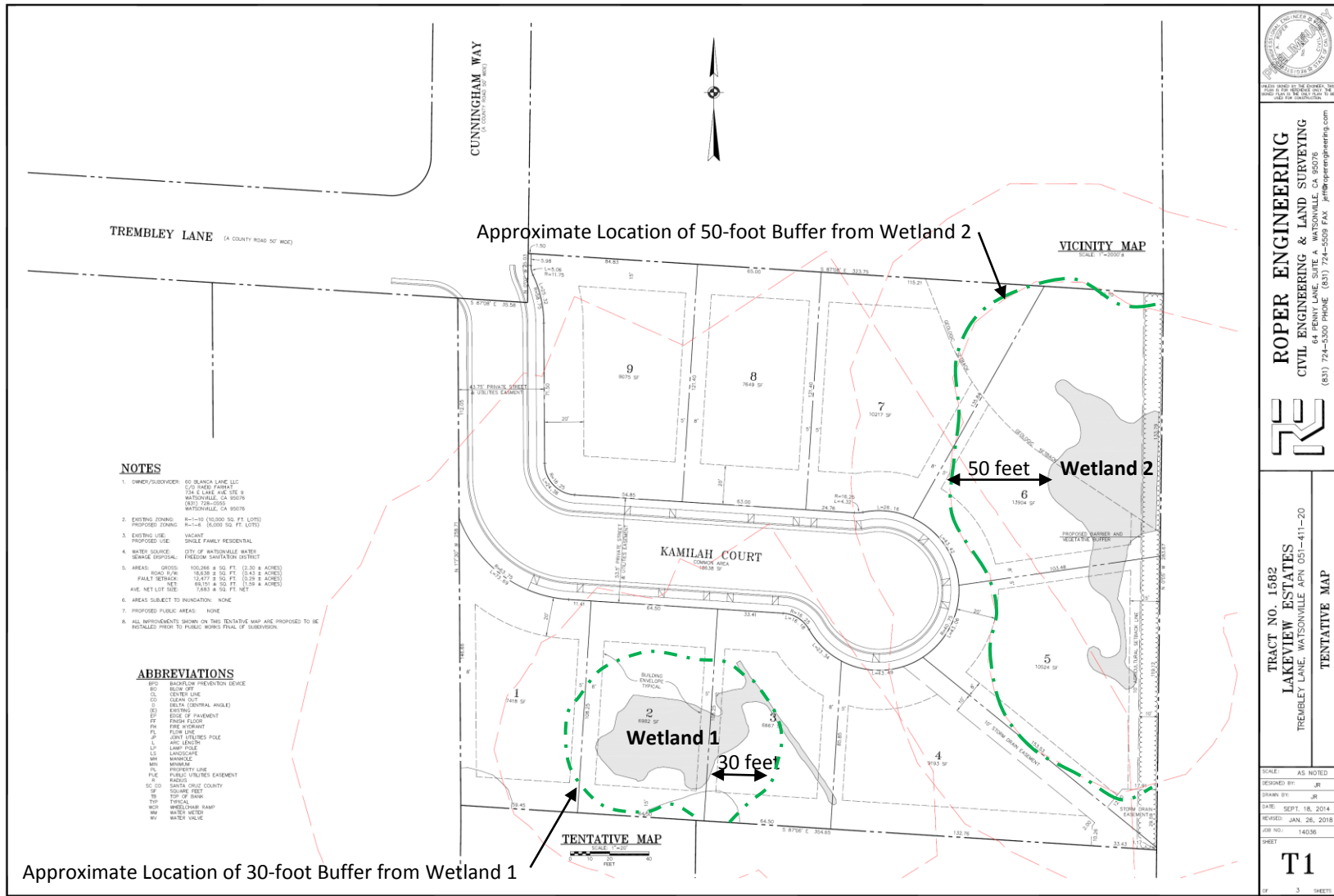
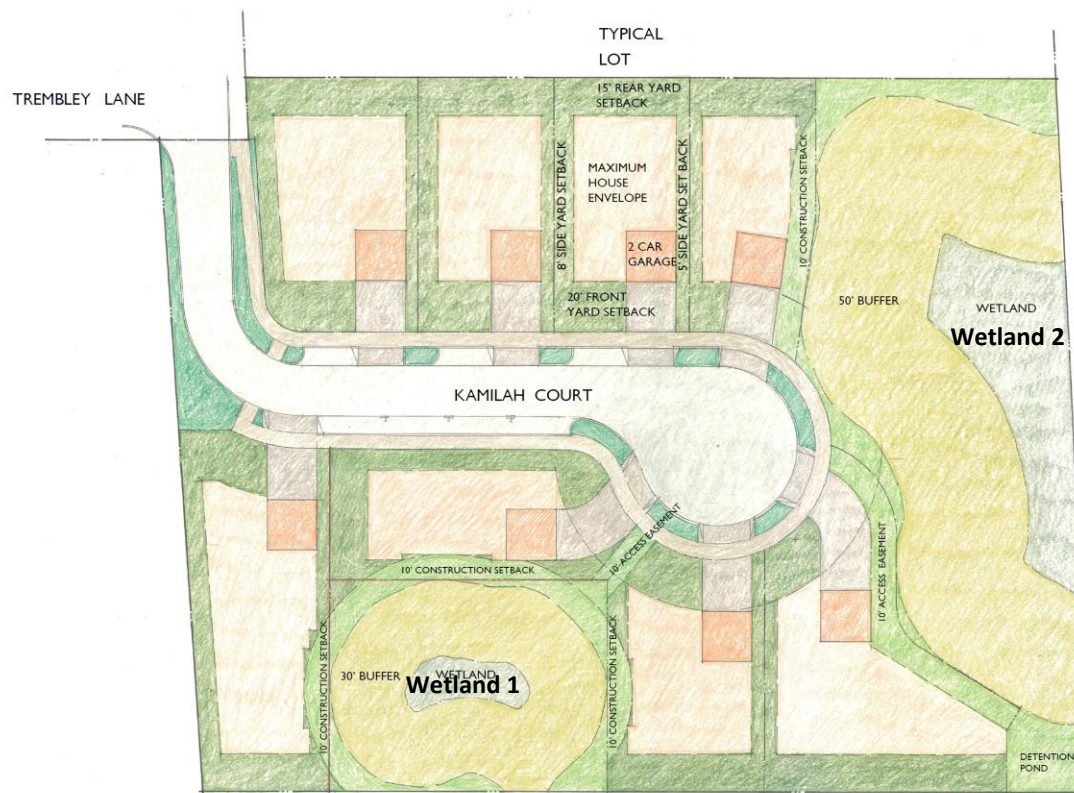

Figure 2. Recommended Buffer to Wetland 1 and Wetland 2



THACHER &
THOMPSON
ARCHITECTS

117 CEDAR STREET SUITE 240
SANTA CRUZ, CA 95060
(831) 457-2939
(831) 457-2937
WWW.TMARCH.COM



PLANNED DEVELOPMENT
TREMBLEY LANE
WATSONVILLE, CA
RAEID FARHAT



MAY 28, 2019

Figure 3. Applicant Site Plan, Showing Proposed Buffers to Wetland 1 and Wetland 2



June 22, 2018

Bryan Mori
Bryan Mori Biological Consulting Services
1016 Brewington Avenue
Watsonville, CA 95076

Re: Special-Status Plant Survey, Lakeview Estates, Watsonville, Santa Cruz County, California

Dear Bryan:

At your request, I conducted a special-status plant survey on the Lakeview Estates property (APN 051-411-20) located southeast of the intersection of Trembley Lane and Cunningham Way in unincorporated Watsonville, Santa Cruz County, California (“study area”) (Figure 1). The proposed project on the study area consists of residential development, as shown on site plans, dated December 30, 2014, prepared by Roper Engineering.

STUDY AREA

The study area for the plant survey covers ~2.3-acres and includes the entire Lakeview Estates property. The study area is currently undeveloped, but heavily disturbed by human activity, including vehicle activity, a storage container, and piles of soil in the central portion of the study area. Surrounding land uses consist of agricultural land to the east, dense residential development to the west, and undeveloped or low-density residential land to the north and south.

Vegetation

Four habitats are present on the study area: Non-Native Grassland, Coast Live Oak Woodland, Willow Scrub, and Rush-Blackberry (Figure 2). A ruderal phase of Non-Native Grassland¹, composed of the *Avena* and other non-native herbaceous Alliances², covers most of the study area and is dominated by non-native grasses and forbs adapted to disturbance, including ripgut brome (*Bromus diandrus*³), wild oats (*Avena* sp.), barley (*Hordeum murinum* subsp. *leporinum*), black mustard (*Brassica nigra*), vetch (*Vicia sativa*), redstem filaree (*Erodium cicutarium*), cheese weed (*Malva* sp.), rescue grass (*Bromus catharticus*), rattail fescue (*Festuca myuros*), Italian ryegrass (*Festuca perennis*), sheep sorrel (*Rumex acetosella*), soft chess (*Bromus hordeaceus*), wild radish (*Raphanus sativus*), English plantain (*Plantago lanceolata*), and rough cat’s-ear (*Hypochaeris radicata*), with occasional native species present including coyote brush (*Baccharis pilularis*) and California poppy (*Eschscholzia californica*). Coast Live Oak Woodland, composed of the *Quercus agrifolia* Woodland Alliance, occurs along the northern study area boundary and as small stands or isolated trees in the eastern portion of the study area. This habitat is dominated by a canopy of coast live oak (*Quercus agrifolia*), with an understory of poison oak (*Toxicodendron diversilobum*), California blackberry (*Rubus ursinus*), Bermuda buttercup (*Oxalis pes-caprae*), and herbaceous species characteristic of Non-Native Grassland described above.

¹ Vegetation nomenclature follows Holland (1986).

² Alliance nomenclature follows Sawyer et al. (2009).

³ Botanical nomenclature follows Baldwin et al. (2012) and The Jepson Flora Project (2018).

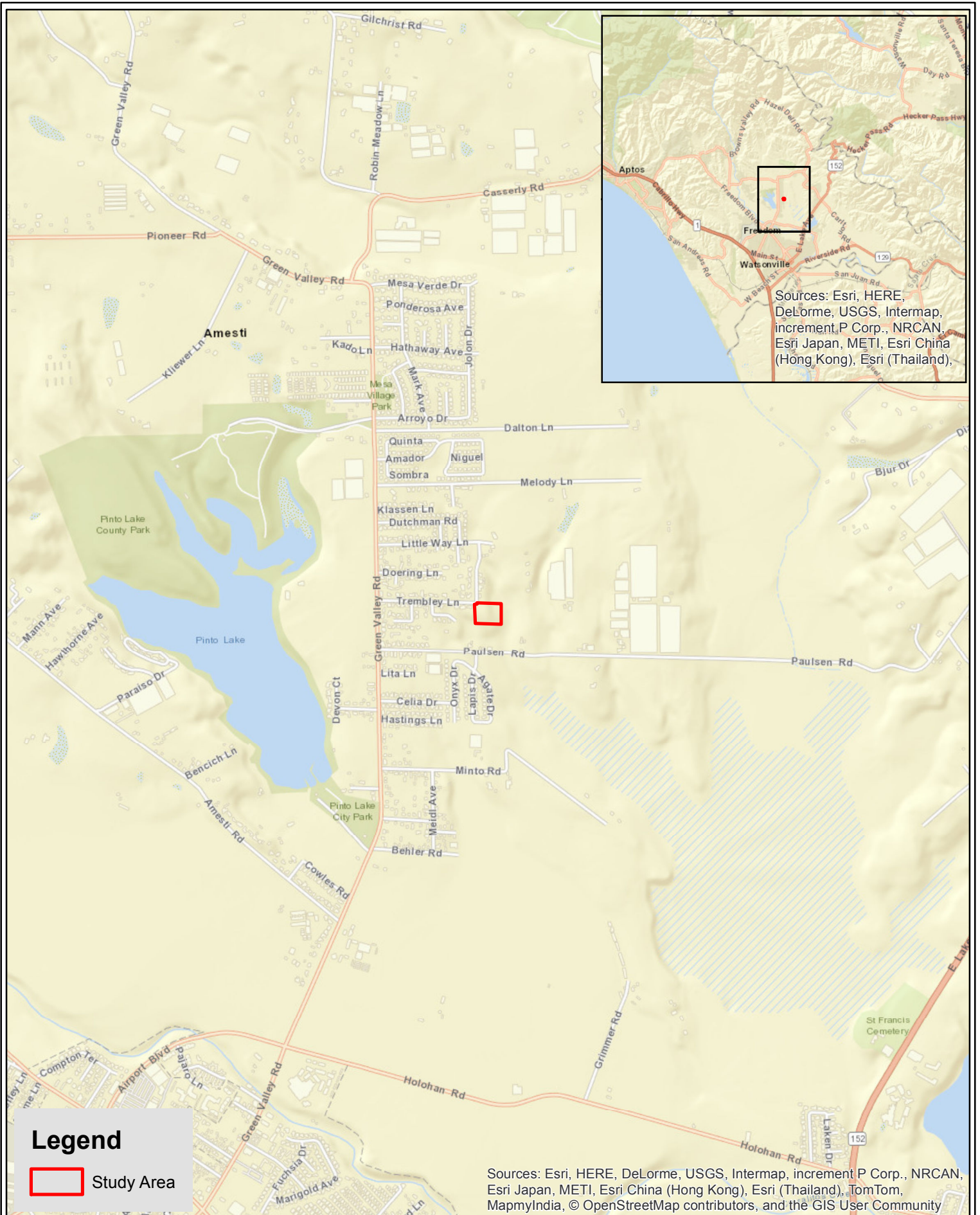
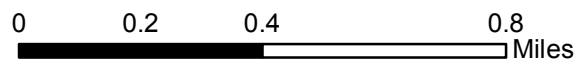

Figure 1. Study area locality map.

Mapscale: 1:20,000





Legend

- Study Area
- Non-Native Grassland
- Coast Live Oak Woodland
- Rush-Blackberry
- Willow Scrub
- Pine

Source: Esri, DigitalGlobe, GeoEye, Earthstar Geographics, CNES/Airbus DS, USDA, USGS, AeroGRID, IGN, and the GIS User Community

Figure 2. Habitats on the study area.
 Orthophoto Date: (7/23/16)

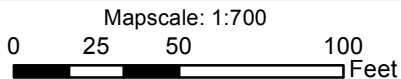

Willow Scrub occurs in the northeastern corner of the study area in low-lying, generally concave topography that appears to collect surface and/or shallow subsurface water draining from upslope areas to the west. This habitat is dominated by willow (*Salix* sp.), with other hydrophytic plant species present, including tall flatsedge (*Cyperus eragrostis*), spreading rush (*Juncus patens*), and rabbitsfoot grass (*Polypogon monspeliensis*). Rush-Blackberry consists of a potential seep area and adjacent man-made ditch dominated by spreading rush and Himalayan blackberry (*Rubus armeniacus*) in the southwestern portion of the study area. In addition, planted trees are present along the property boundary, including several pine (*Pinus* sp.) trees along the southwestern study area boundary.

Geology, Climate, and Soils

The study area occurs between ~95 and 130-foot elevation (USGS 1954) and is underlain by marine and continental sedimentary rocks (older alluvium, lake, playa, and terrace deposits) of Pleistocene age (California Geological Survey 2010). Average annual precipitation in the region is 21.52 inches, occurring primarily between October and May (Western Regional Climate Center 2018).

Two soil types have been mapped on the study area in the Web Soil Survey (NRCS 2018a):

163—Pinto loam, 9 to 15 percent slopes

177—Watsonville loam, 2 to 15 percent slopes

Pinto Series soils are classified as Fine-loamy, mixed, superactive, thermic Typic Argixerolls. Pinto loam, 9 to 15 percent slopes, is a moderately well-drained soil derived from alluvium and/or marine deposits and is typically found on alluvial fans and terraces. A typical profile consists of loam from 0 to 21 inches and sandy clay loam, clay loam, and/or loam from 21 to 51 inches. The depth to water table and a restrictive feature is >80 inches beneath the surface.

Watsonville Series soils are classified as Fine, smectitic, thermic Xeric Argialbolls. Watsonville loam, 2 to 15 percent slopes, is a somewhat poorly drained soil derived from alluvium and is typically found on marine terraces. A typical profile consists of loam from 0 to 18 inches and clay, clay loam, and/or sandy clay loam from 18 to 39 inches of soil profile. The depth to water table is >80 inches and the depth to a restrictive feature (abrupt textural change) is ~18 inches beneath the surface.

Both of these soils can be considered hydric soils for Santa Cruz County when found on marine terraces (NRCS 2018b).

METHODS

Prior to the field visits, a background literature search was conducted to determine which special-status plants have potential to occur on the study area (Appendix A; Figure 3). The sources for the background literature search included the California Natural Diversity Database (CDFW 2018a) (Watsonville West 7.5' USGS quad and surrounding quads), the California Native Plant Society Inventory of Rare and Endangered Plants (CNPS 2018), and the U.S. Fish and Wildlife Service (USFWS) list of threatened or endangered species (USFWS 2018a). The background literature search identified documented species in the region with potential to occur on the study area (Figure 3) and helped guide the timing and focus of the surveys, but the surveys were floristic in nature and all plant species observed were identified to the level necessary to determine rarity and listing status (CDFW 2018b) (Appendix B). The plant surveys were conducted on March 27 (as part of a botanical reconnaissance), May 22, and June 22, 2018. During the surveys, the study area was traversed systematically on foot using intuitive-controlled methodology as outlined in Nelson (1987), CNPS (2001), and CDFW (2018b). Plants that could not be identified in the

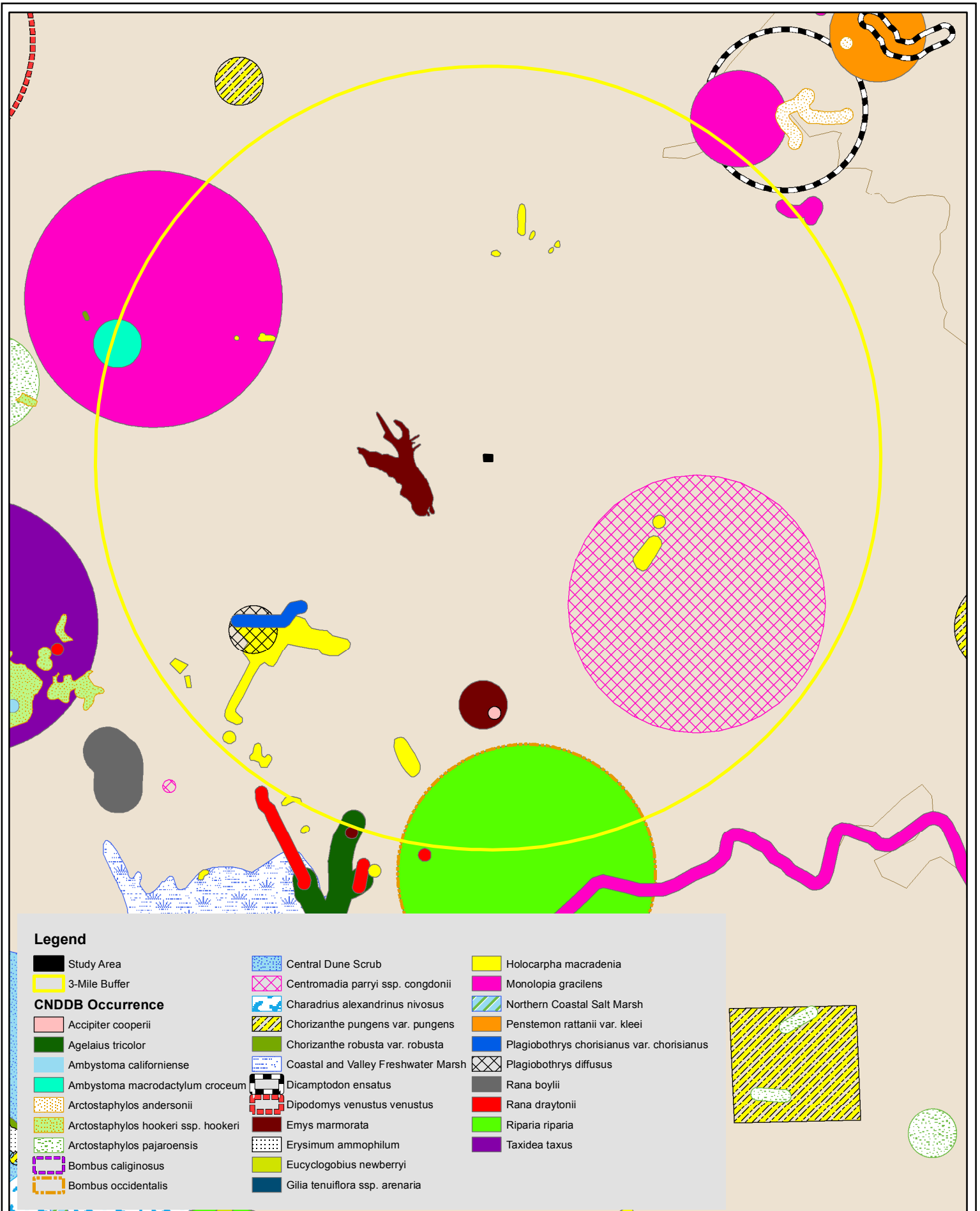
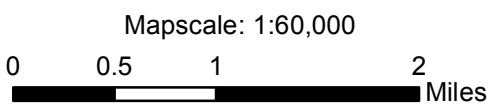

Figure 3. CNDDDB map of the study area.

Data Source: CNDDDB (CDFW 2018).



field were taken back to the lab and keyed using Baldwin et al. (2012) and the Jepson Flora Project (2018).

LIMITATIONS

The results of this special-status plant survey are based on conditions observed during the field visits, and my interpretation of those conditions. Vegetation is dynamic, and plants that are present and/or dominant at the time of this survey may shift in importance depending on rainfall conditions and season, population shifts over time, and/or natural or human disturbance. Species not observed during this survey could establish on the study area due to natural recruitment from offsite sources and/or the soil seed bank. Government regulatory agencies (subject to administrative appeal and judicial review) make the final determination regarding botanical resources on the study area.

RESULTS AND RECOMMENDATIONS

Forty-two special-status plant species have been documented in the study area region based on the background literature search discussed previously. A list of these species is included in Appendix A. The study area is not located within designated Critical Habitat for any federally-listed plant species (USFWS 2018b). No special-status plants have been documented to occur on the study area in the CNDDDB (CDFW 2018a), but numerous special-status plant species have been documented in the vicinity (Figure 3).

During the March, May, and June, 2018 plant surveys, 72 plant species were observed on the study area (Appendix B). None of these are special-status species. Though the study area has been subject to past disturbance, no mowing or significant vegetation removal had occurred prior to the surveys which could impact plant identification. Precipitation for the 2017-2018 water year was below average for Watsonville (~13.35 inches, compared to an annual average of ~21.52 inches), but significant precipitation occurred during the spring. Based on the growth and phenological development of spring and summer-blooming annual and perennial species observed on the study area and the surrounding region in March, May, and June, 2018, vegetation conditions appeared typical for the season despite reduced rainfall, and any plant species present on the study area should have been identifiable.

Since no special-status plants were observed during the surveys, which were spaced throughout the blooming season of potentially occurring plant species, special-status plants are unlikely to inhabit the study area and no further botanical surveys are recommended.

Please contact me if you have questions or need additional information.

Sincerely,

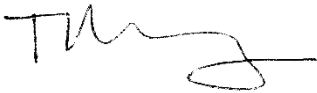

Tom Mahony, MS, PWS
Principal/Plant Ecologist

REFERENCES

- Baldwin, B.G., D.H. Goldman, D.J. Keil, R. Patterson, T.J. Rosatti, and D.H. Wilken, editors. 2012. The Jepson manual: vascular plants of California, second edition. University of California Press, Berkeley.
- California Department of Fish and Wildlife. 2018a. California natural diversity database. California Department of Fish and Wildlife, Sacramento, CA.
- _____. 2018b. Protocols for surveying and evaluating impacts to special status native plant populations and natural communities. Dated March 20.
- California Geological Survey. 2010. Geologic map of California. Accessed at http://www.conservation.ca.gov/cgs/cgs_history/Pages/2010_geologicmap.aspx.
- California Native Plant Society. 2001. CNPS botanical survey guidelines. Dated June 2.
- California Native Plant Society. 2018. Inventory of Rare and Endangered Plants (online edition). California Native Plant Society. Sacramento, CA.
- Holland, R.F. 1986. Preliminary descriptions of the terrestrial natural communities of California. California Department of Fish and Game, Sacramento, CA.
- Jepson Flora Project (eds.) 2018. Jepson eFlora, <http://ucjeps.berkeley.edu/eflora/>.
- Natural Resource Conservation Service. 2018a. Web Soil Survey. Accessed at: <http://websoilsurvey.nrcs.usda.gov/app/WebSoilSurvey.aspx>.
- _____. 2018b. Lists of hydric soils. Accessed at: <https://www.nrcs.usda.gov/wps/portal/nrcs/main/soils/use/hydric/>
- Nelson, James R. 1987. Rare plant surveys: techniques for impact assessment. From proceedings of a California conference on the conservation and management of rare and endangered plants. California Native Plant Society, Sacramento, CA.
- Sawyer, J.O., T. Keeler-Wolf, and J.M. Evans. 2009. A manual of California vegetation, second edition. California Native Plant Society. Sacramento, CA.
- U. S. Fish and Wildlife Service. 2018a. Information for planning and conservation (IpaC). Accessed at <http://ecos.fws.gov/ipac/>.
- _____. 2018b. Critical habitat portal. Accessed at <http://ecos.fws.gov/crithab>.
- U. S. Geological Survey. 1954. Watsonville West, Calif. 7.5 minute topographic quadrangle. Photorevised 1980.
- Western Regional Climate Center. 2018. 1908-2016 monthly climate summary for Watsonville Water Works, California (049473). Accessed at <http://www.wrcc.dri.edu>.

Appendix A. Special-status plant species documented to occur in the study area region.

List compiled from searches of the CNDDDB (CDFW 2018a), CNPS Inventory of Rare and Endangered Plants (CNPS 2018), and USFWS (2018a) records for the Moss Landing, Soquel, Watsonville East, Watsonville West, Prunedale, Laurel, Mount Madonna, and Loma Prieta 7.5' USGS quadrangles and other publications.

Species	Status	Typical Habitat	Habitat Assessment of Study Area
PLANTS			
<i>Amsinckia lunaris</i> bent-flowered fiddleneck	1B.2	Coastal bluff scrub, cismontane woodland, valley and foothill grassland, 3-500 m. Blooms March-June.	Marginal suitable habitat present in Non-Native Grassland but survey occurred during species' blooming period and it wasn't observed.
<i>Arctostaphylos andersonii</i> Santa Cruz manzanita	1B.2	Broadleafed upland forest, chaparral, North Coast coniferous forest (openings, edges), 60-730 m. Blooms November-April.	No <i>Arctostaphylos</i> observed on the study area.
<i>Arctostaphylos hookeri</i> ssp. <i>hookeri</i> Hooker's manzanita	1B.2	Closed-cone coniferous forest, chaparral, cismontane woodland, coastal scrub (sandy), 85-536 m. Blooms January-June.	No <i>Arctostaphylos</i> observed on the study area.
<i>Arctostaphylos pajaroensis</i> Pajaro manzanita	1B.1	Chaparral (sandy), 30-760 m. Blooms December-March.	No <i>Arctostaphylos</i> observed on the study area.
<i>Arctostaphylos silvicola</i> Bonny Doon manzanita	1B.2	Closed-cone coniferous forest, chaparral, lower montane coniferous forest (inland marine sands), 120-600 m. Blooms January-March.	No <i>Arctostaphylos</i> observed on the study area.
<i>Arenaria paludicola</i> marsh sandwort	FE, SE, 1B.1	Marshes and swamps (freshwater or brackish, sandy openings), 3-170 m. Blooms May-August.	No suitable habitat on the study area.
<i>Calyptridium parryi</i> var. <i>hesseae</i> Santa Cruz Mountains pussypaws	1B.1	Chaparral, cismontane woodland (sandy or gravelly, openings), 305-1,530 m. Blooms May-August.	No suitable habitat on the study area. Out of elevational range.
<i>Castilleja latifolia</i> Monterey Coast paintbrush	4.3	Closed-cone coniferous forest, cismontane woodland (openings), coastal dunes, coastal scrub (sandy), 0 - 185 m. Blooms February-September.	No suitable habitat on the study area.
<i>Ceanothus ferrisiae</i> Coyote ceanothus	FE, 1B.1	Chaparral, coastal scrub, valley and foothill grassland (serpentinite), 120-460 m. Blooms January-May.	No suitable habitat on the study area. No <i>Ceanothus</i> observed.
<i>Ceanothus rigidus</i> Monterey ceanothus	4.2	Closed-cone coniferous forest, chaparral, coastal scrub (sandy), 3-550 m. Blooms February-April (June).	No suitable habitat on the study area. No <i>Ceanothus</i> observed.
<i>Centromadia parryi</i> subsp. <i>congdonii</i> Congdon't tarplant	1B.1	Valley and foothill grassland (alkaline), 1-230 m. Blooms May-October.	No suitable alkaline habitat on the study area.
<i>Chorizanthe pungens</i> var. <i>hartwegiana</i> Ben Lomond spineflower	FE, 1B.1	Lower montane coniferous forest (maritime ponderosa pine sandhills), 90-610. Blooms April-July	No suitable habitat on the study area.

Species	Status	Typical Habitat	Habitat Assessment of Study Area
<i>Chorizanthe pungens</i> var. <i>pungens</i> Monterey spineflower	FT, 1B.2	Chaparral (maritime), cismontane woodland, coastal dunes, coastal scrub, valley and foothill grassland (sandy), 3-450 m. Sandy soils in coastal dunes or more inland within chaparral or other habitats. Blooms April-August.	Suitable sandy habitat lacking.
<i>Chorizanthe robusta</i> var. <i>hartwegii</i> Scotts Valley spineflower	FE, 1B.1	Meadows and seeps (sandy), valley and foothill grassland (mudstone and Purisima outcrops), 230-245 m. Blooms April-July.	No suitable habitat on the study area. Out of range.
<i>Chorizanthe robusta</i> var. <i>robusta</i> robust spineflower	FE, 1B.1	Maritime chaparral, cismontane woodland, coastal dunes, coastal scrub (sandy or gravelly), 3-330 m. Blooms April-September.	Suitable sandy habitat lacking.
<i>Clarkia concinna</i> ssp. <i>automixa</i> Santa Clara red ribbons	4.3	Chaparral, cismontane woodland, 90-1,500 m. Blooms May-June.	No suitable habitat on the study area.
<i>Cordylanthus rigidus</i> ssp. <i>littoralis</i> seaside bird's-beak	SE, 1B. 1	Closed-cone coniferous forest, chaparral (maritime), cismontane woodland, coastal dunes, coastal scrub (sandy, often disturbed sites), 0-515 m. Blooms April-October.	No suitable habitat on the study area.
<i>Ericameria fasciculata</i> Eastwood's goldenbush	1B.1	Closed-cone coniferous forest, chaparral, coastal dunes, coastal scrub (sandy openings), 30-275 m. Blooms July-Oct.	No suitable habitat on the study area. Not observed.
<i>Eriogonum nudum</i> var. <i>decurrens</i> Ben Lomond buckwheat	1B.1	Chaparral, cismontane woodland, lower montane coniferous forest (sandy maritime ponderosa pine sandhills), 50-800 m. Blooms June-October.	No suitable habitat on the study area.
<i>Erysimum ammophilum</i> sand-loving wallflower	1B.2	Chaparral (maritime), coastal dunes, coastal scrub (sandy, openings), 0-60 m. Blooms February-June.	No suitable habitat on the study area.
<i>Erysimum teretifolium</i> Santa Cruz wallflower	FE, SE, 1B.1	Chaparral, lower montane coniferous forest (inland marine sands), 120-610 m. Blooms March-July.	No suitable habitat on the study area.
<i>Fissidens pauperculus</i> minute pocket moss	1B.2	North Coast coniferous forest (damp coastal soil, in dry streambeds and streambanks), 10-1,024 m.	No suitable habitat on the study area.
<i>Fritillaria liliacea</i> fragrant fritillary	1B.2	Cismontane woodland, coastal prairie, coastal scrub, valley and foothill grassland (often serpentinite), 3-410 m. Blooms February-April.	Marginal suitable habitat present in Non-Native Grassland but survey occurred during species' blooming period and it wasn't observed.
<i>Gilia tenuiflora</i> ssp. <i>arenaria</i> Monterey gilia	FE, ST, 1B.2	Chaparral (maritime), cismontane woodland, coastal dunes, coastal scrub (sandy, openings), 0-45 m. Blooms April-June.	No suitable habitat on the study area.

Species	Status	Typical Habitat	Habitat Assessment of Study Area
<i>Hoita strobilina</i> Loma Prieta hoita	1B.1	Chaparral, cismontane woodland, riparian woodland (usually serpentinite, mesic), 30-860 m. Blooms May-October.	No suitable habitat on the study area.
<i>Holocarpa macradenia</i> Santa Cruz tarplant	FT, SE, 1B.1	Coastal prairie, coastal scrub, valley and foothill grassland (often clay), 10-220 m. Blooms June-October.	Some marginal habitat components present but study area is heavily disturbed and suitable micro-habitat lacking. Survey occurred during species' blooming period and it wasn't observed.
<i>Horkelia cuneata</i> var. <i>sericea</i> Kellogg's horkelia	1B.1	Closed-cone coniferous forest, chaparral, coastal dunes, old sand hills, coastal scrub (sandy or gravelly openings), 10-200 m. Blooms April-September.	Suitable sandy habitat lacking.
<i>Lasthenia californica</i> ssp. <i>macrantha</i> perennial goldfields	1B.2	Coastal bluff scrub, coastal dunes, coastal scrub, 5-520 m. Blooms January-November.	No suitable habitat on the study area.
<i>Lessingia micradenia</i> var. <i>glabrata</i> smooth lessingia	1B.2	Chaparral, cismontane woodland (serpentinite, often roadsides), blooms 120 - 420 m. Blooms July-November.	No suitable habitat on the study area.
<i>Malacothamnus arcuatus</i> arcuate bush mallow	1B.2	Chaparral, cismontane woodland, 15-355 m. Blooms April-September.	No suitable habitat on the study area. No <i>Malacothamnus</i> observed.
<i>Monardella sinuata</i> ssp. <i>nigrescens</i> northern curly-leaved monardella	1B.2	Chaparral (SCR Co.), coastal dunes, coastal scrub, lower montane coniferous forest (SCR Co., ponderosa pine sandhills), 0-300 m. Blooms May-July (sometimes Aug-Sept).	No suitable habitat on the study area.
<i>Monolopia gracilens</i> woodland woollythreads	1B.2	Broadleaved upland forest openings, chaparral openings, cismontane woodland, North Coast coniferous forest openings, valley and foothill grassland (serpentine), sandy to rocky soils, 100-1,200 m. Blooms March-July.	No suitable habitat on the study area.
<i>Pedicularis dudleyi</i> Dudley's lousewort	1B.2, SR	Chaparral (maritime), cismontane woodland, North Coast coniferous forest, valley and foothill grassland, 60 to 900 m. Blooms April-June.	No suitable habitat on the study area.
<i>Penstemon rattanii</i> var. <i>kleei</i> Santa Cruz Mountains beardtongue	1B.2	Chaparral, lower montane coniferous forest, North Coast coniferous forest, 400-1,100 m. Blooms May-June.	No suitable habitat present on the study area. Out of elevational range.
<i>Pentachaeta bellidiflora</i> white-rayed pentachaeta	FE, SE, 1B.1	Cismontane woodland, coastal scrub, valley and foothill grassland (often serpentinite), 35-620 m. Blooms March-May.	No suitable habitat on the study area.
<i>Piperia yadonii</i> Yadon's rein orchid	FE, 1B.1	Closed-cone coniferous forest, coastal bluff scrub, chaparral (maritime)/sandy, 10-510 m. Blooms May-August.	No suitable habitat on the study area.

Species	Status	Typical Habitat	Habitat Assessment of Study Area
<i>Plagiobothrys chorisianus</i> var. <i>chorisianus</i> Choris' popcorn-flower	1B.2	Chaparral, coastal prairie, coastal scrub (mesic), 15-100 m. Blooms March-June.	Marginal suitable habitat present in Non-Native Grassland but survey occurred during species' blooming period and it wasn't observed.
<i>Plagiobothrys diffusus</i> San Francisco popcorn-flower	SE, 1B.1	Coastal prairie, valley and foothill grassland, 60-360 m. Blooms March-June.	Marginal suitable habitat present in Non-Native Grassland but survey occurred during species' blooming period and it wasn't observed.
<i>Polygonum hickmanii</i> Scotts Valley polygonum	FE, SE, 1B.1	Valley and foothill grassland (mudstone and sandstone), 210-250 m. Blooms May-August.	No suitable habitat on the study area.
<i>Rosa pinetorum</i> pine rose	1B.2	Closed-cone coniferous forest, 2-300 m. Blooms May-July.	No suitable habitat on the study area. Not observed.
<i>Trifolium buckwestiorum</i> Santa Cruz clover	1B.1	Broadleafed upland forest, cismontane woodland, coastal prairie (gravelly, margins), 105-610 m. Blooms April-October.	Some marginal habitat components present but suitable micro-habitat lacking. Survey occurred during species' blooming period and it wasn't observed.
<i>Trifolium hydrophilum</i> saline clover	1B.2	Marshes and swamps, valley and foothill grassland (mesic/alkaline), vernal pools, 0-300 m. Blooms April-June.	Suitable alkaline habitat lacking.
Key to Status:			
FE	Federal Endangered		
FT	Federal Threatened		
SE	State Endangered		
ST	State Threatened		
SR	State Rare		
1B	CNPS Rare Plant Rank of plants rare, threatened, or endangered in California and elsewhere		
2	CNPS Rare Plant Rank of plants rare, threatened, or endangered in California but more common elsewhere		
3	CNPS Rare Plant Rank of plants for which more information is needed; a review list		
4	CNPS Rare Plant Rank of plants of limited distribution: a watch list		
.1/.2/.3	Seriously endangered in California/Fairly endangered in California/ Not very endangered in California		

Appendix B. Plant species observed on the study area, March 27, May 22, and June 22, 2018.

Scientific Name	Common Name
<i>Acmispon americanus</i>	Spanish lotus
<i>Agoseris</i> sp.*	agoseris
<i>Artemisia douglasiana</i>	mugwort
<i>Avena barbata</i> *	slender wild oat
<i>Baccharis glutinosa</i>	marsh baccharis
<i>Baccharis pilularis</i>	coyote brush
<i>Brassica nigra</i> *	black mustard
<i>Brassica rapa</i> *	field mustard
<i>Briza minor</i> *	little quaking grass
<i>Bromus carinatus</i>	California brome
<i>Bromus catharticus</i> *	rescue grass
<i>Bromus diandrus</i> *	ripgut brome
<i>Bromus hordeaceus</i> *	soft chess
<i>Carduus pycnocephalus</i> *	Italian thistle
<i>Cichorium intybus</i> *	chicory
<i>Cirsium vulgare</i> *	bull thistle
<i>Conium maculatum</i> *	poison hemlock
<i>Convolvulus arvensis</i> *	field bindweed
<i>Cortaderia jubata</i> *	pampas grass
<i>Cyperus eragrostis</i>	tall flatsedge
<i>Epilobium ciliatum</i>	willow herb
<i>Erigeron canadensis</i>	horseweed
<i>Erodium botrys</i> *	filaree
<i>Erodium cicutarium</i> *	redstem filaree
<i>Eschscholzia californica</i>	California poppy
<i>Festuca bromoides</i> *	brome fescue
<i>Festuca myuros</i> *	rattail fescue
<i>Festuca perennis</i> *	Italian ryegrass
<i>Galium aparine</i>	goose grass
<i>Gastridium phleoides</i> *	nit grass
<i>Geranium dissectum</i> *	cutleaf geranium
<i>Helminthotheca echioides</i> *	bristly ox-tongue
<i>Hirschfeldia incana</i> *	summer mustard
<i>Holcus lanatus</i> *	velvet grass
<i>Hordeum murinum</i> subsp. <i>leporinum</i> *	barley
<i>Hypochaeris radicata</i> *	rough cat's-ear
<i>Juglans</i> sp.	walnut
<i>Juncus effusus</i>	soft rush
<i>Juncus patens</i>	spreading rush
<i>Lactuca serriola</i> *	prickly lettuce
<i>Lotus corniculatus</i> *	birds-foot trefoil
<i>Lysimachia arvensis</i> *	scarlet pimpernel
<i>Malva</i> sp.*	mallow
<i>Medicago polymorpha</i> *	bur clover
<i>Mentha pulegium</i> *	pennyroyal
<i>Oxalis pes-caprae</i> *	Bermuda buttercup
<i>Persicaria</i> sp.	smartweed

Scientific Name	Common Name
<i>Phalaris aquatica</i> *	Harding grass
<i>Pinus</i> sp.*	pine
<i>Plantago lanceolata</i> *	English plantain
<i>Polypogon monspeliensis</i> *	rabbitsfoot grass
<i>Populus</i> sp.	cottonwood
<i>Quercus agrifolia</i>	coast live oak
<i>Raphanus sativus</i> *	wild radish
<i>Rubus armeniacus</i> *	Himalayan blackberry
<i>Rubus ursinus</i>	California blackberry
<i>Rumex acetosella</i> *	sheep sorrel
<i>Rumex crispus</i> *	curly dock
<i>Rumex pulcher</i> *	fiddle dock
<i>Rumex</i> sp.	dock
<i>Salix</i> sp.	willow
<i>Senecio vulgaris</i> *	common groundsel
<i>Solanum</i> sp.	nightshade
<i>Sonchus asper</i> subsp. <i>asper</i> *	prickly sow thistle
<i>Sonchus oleraceus</i> *	sow thistle
<i>Symphyotrichum chilense</i>	California aster
<i>Toxicodendron diversilobum</i>	poison oak
<i>Tragopogon porrifolius</i> *	salsify
<i>Typha angustifolia</i>	narrow-leaved cattail
<i>Verbena lasiostachys</i>	western vervain
<i>Vicia sativa</i> *	vetch
<i>Vicia villosa</i> *	hairy vetch
* = non-native species	



COUNTY OF SANTA CRUZ

PLANNING DEPARTMENT

701 OCEAN STREET, 4TH FLOOR, SANTA CRUZ, CA 95060
(831) 454-2580 FAX: (831) 454-2131 TDD: (831) 454-2123
KATHLEEN MOLLOY, PLANNING DIRECTOR

Kamilah Deyn Development LLC
Attn: Raeid Farhat
734 E Lake Ave 9
Watsonville CA, 95076

November 8, 2019

Additional Contact:
Charles Eadie
charlie@eadieconsultatns.com

Subject: Trembley Lane Biotic Report Review and Conditioned Biotic Approval

APN: 051-411-20

Application #s: REV191105

Attachment 1. Aquatic Resource Delineation and Wetland Review

Attachment 2. Special-Status Plant Survey Report

Dear Mr. Farhat and Mr. Eadie,

The Planning Department received and reviewed an Aquatic Resource Delineation Report dated May 2018 and a Special Status Plant Survey dated June 22, 2018, prepared by Coast Range Biological, and a Wetland Review dated July 22, 2019, prepared by Biotic Resources Group for APN 051-411-20. The Reports were prepared because of the potential for sensitive habitats and protected species on this parcel, where a small subdivision may be proposed in the future. Copies of the Reports are included as Attachments 1 and 2.

According to a letter provided by the applicant in August of 2019, the lot arrangement for a small subdivision proposed on this parcel has gone through several design changes in response to environmental site conditions, including two wetlands that were identified on the parcel. A conceptual drawing of a proposed subdivision configuration was included as Figure 3 in the 2019 Wetland Review, but the County does not have a current development application on file proposing a specific project or subdivision map for this parcel.

The approximately 2.3-acre study area is currently undeveloped. The site has been heavily disturbed by past human activity, including vehicle activity, vegetation removal, and grading. No permits were issued by the County for these past activities. There are several man-made trenches on the property and spoils piles in the central portion of the parcel. Four habitats are present in the study area: Non-Native Grassland, Coast Live Oak Woodland, Willow Scrub, and Rush-Blackberry.

The study area is dominated by Non-native Grassland which includes a variety of herbaceous vegetation adapted to disturbance such as ripgut brome (*Bromus diandrus*), wild oats (*Avena* sp.), barley (*Hordeum murinum* subsp. *leporinum*), and black mustard (*Brassica nigra*), with occasional native species present including coyote brush (*Baccharis pilularis*) and California poppy (*Eschscholzia californica*).

Coast Live Oak Woodland, composed of the *Quercus agrifolia* Woodland Alliance, occurs along the northern study area boundary. Small stands and isolated oak trees also occur in the eastern portion of the study area. This habitat is dominated by a canopy of coast live oak (*Quercus agrifolia*), with an understory of poison oak (*Toxicodendron diversilobum*), California blackberry (*Rubus ursinus*), Bermuda buttercup (*Oxalis pescaprae*), and herbaceous species characteristic of Non-Native Grassland described above. Oak woodlands are considered sensitive habitats under the County's Sensitive Habitat Protection Ordinance.

Special-status plant surveys were conducted on the parcel in March, May and June of 2018 to coincide with the evident and identifiable period for all special status plant species with potential to occur in the area. The surveys were floristic in nature, and a complete list of species observed is included in the attached Special Status Plant Survey Report. No special-status plants were observed during the surveys.

The project site provides potential habitat for nesting birds. Birds of prey and migratory birds are protected under the California Fish and Game Code, and the Federal Migratory Bird Treaty Act (MBTA). Under the MBTA, it is "unlawful at any time, by any means or in any manner, to pursue, hunt, take, capture, kill, attempt to take, capture, or kill" a migratory bird unless and except as permitted by regulations. The project site does not contain habitat for any other special-status wildlife species.

Two wetlands were identified on the parcel during the wetland delineation studies conducted in May of 2018 and confirmed during the July 2019 Wetland Review. Environmental Planning staff visited the project site with consulting biologists Bill Davilla and Justin Davilla of Ecosystems West Consulting Group (Ecosystems West) on September 10, 2019 to verify the location and characteristics of the two wetlands. Wetland 1 occurs in the southwestern portion of the study area on sloped terrain that appears to receive surface and near-surface runoff from upslope. This wetland is dominated by Himalayan blackberry and spreading rush and was mapped during the 2018 delineation to include a natural seep and a man-made drainage ditch. This feature does not provide habitat for special status wildlife species. No soil data points were taken in the man-made drainage ditch. Wetland 2 occurs in the eastern portion of the study area in a shallow swale at the toe of a slope. Much of Wetland 2 is dominated by re-vegetating areas of willow and herbaceous species such as flatsedge, Italian ryegrass, pennyroyal, birds-foot trefoil and rabbits foot grass. The 2018 Wetland Study and the 2019 Wetland Review consider Wetland 2 as remnant of the riparian corridor of Stream 533, an intermittent stream which crosses the adjacent parcel downslope to the east.

Riparian Corridors, as defined by Santa Cruz County Code Section 16.30.030, are granted protections under the County's Sensitive Habitat Protection and Riparian Corridor and Wetlands Protection ordinances. Lands extending 100 feet (measured horizontally) from the high-water mark of a lake, *wetland*, estuary, lagoon or natural body of standing water, lands extending 30 feet (measured horizontally) out from each side of an intermittent stream, and lands containing a

riparian woodland are considered Riparian Corridors. Riparian corridors associated with arroyos within the urban services boundary are subject to additional protective buffers and setbacks for development as defined in SCCC 16.30.040. Development activities are prohibited within Riparian Corridors unless an Exception is granted, and Riparian Exception Findings (SCCC 16.30.060) must be met for a Riparian Exception to be authorized.

Wetland 1 is an isolated feature dominated by non-native Himalayan blackberry. While this feature meets the three parameters that define a wetland, in its current condition it is highly degraded and has very low habitat value for wildlife or water quality. Wetland 1 is subject to the protections of the defined 100-foot riparian corridor as outlined in SCCC 16.30.030.

Encroachment into this buffer would require a Riparian Exception. The July 2019 Wetland Review includes a proposal for a reduction in size of the Riparian Corridor of Wetland 1. Santa Cruz County Code does not offer provisions for a reduction in the size of the protected Riparian Corridor, and development within the protected Riparian Corridor may only be authorized via a Riparian Exception, as described above. The 2019 Wetland Review also presents a change in the delineated boundaries of Wetland 1 by removing the manmade drainage feature from the exhibits. Man-made features can develop into wetlands over time if the correct hydrologic and soil conditions are met. The boundaries of Wetland 1 were delineated based on hydrophytic vegetation, and no soil data points were taken in the man-made drainage ditch. To remove this drainage feature from the delineated boundaries of Wetland 1, additional upland and wetland data points would be needed to confirm absence of wetland soils and hydrology indicators.

Wetland 2 appears to be associated with the remnant riparian corridor of Stream 533 that has been disturbed by previous grading and vegetation removal on the parcel. The scattered oaks along this eastern portion of the property are also associated with the hydrology of Stream 533 that drains from north to south along the lower portions of this sloped parcel. The riparian corridor of intermittent Stream 533 is also considered an urban arroyo. The boundary and buffers associated with this riparian corridor must be mapped and a 10-foot setback from the edge of the buffer is required for all structures. These buffers are dependent on vegetation type and slope and are determined based on the criteria found in the Tables in Section 16.30.040 of the County Code.

The wetlands on the property may be regulated under the Clean Water Act Section 404 by the U.S. Army Corps of Engineers (USACE), and Section 401 by the Regional Water Quality Control Board (RWQCB). The associated banks of the drainages may be subject to regulation under the Porter-Cologne Water Quality Act as “Waters of the State”, and under California Fish and Game Code Section 1602.

There are sensitive habitat constraints on the project site associated with wetlands, oak woodlands, and habitat for nesting birds that must be considered prior to and during project implementation. The Conditions of Approval below shall be incorporated into any development permits issued for parcel 051-411-20.

Conditions of Approval

In order to conduct development activities on parcel 051-411-20 the following conditions shall be adhered to:

1. No work shall occur within a County defined Riparian Corridor unless the Riparian Exception Findings are met, and a Riparian Exception is authorized.
2. The boundaries and buffers for all sensitive habitats must be reviewed and approved by County Environmental Planning Staff prior to final subdivision map approval, and these boundaries and buffers for sensitive habitats shall be included on the final subdivision map and all maps for future development proposed on the parcel.
3. To minimize impacts to oak woodlands and riparian woodland habitat:
 - The boundary and buffers associated with the riparian woodland habitat/urban arroyo of Stream 533, located along the eastern portion of the property, shall be delineated and flagged in the field by a qualified biologist and mapped as sensitive habitat. The 10-foot setback from the edge of the buffer shall also be included on the map.
 - The boundaries of oak woodland habitat shall be delineated at or outside of the dripline of oak trees on the property and flagged in the field by a qualified biologist and mapped as sensitive habitat.
 - Prior to construction, high visibility construction fencing shall be installed, with the assistance of a qualified biologist, around areas identified as sensitive habitat to indicate the limits of work (limits of grading) and prevent inadvertent grading or other disturbance within the surrounding sensitive habitats. No work-related activity including equipment staging, vehicular access, and grading shall be allowed outside the limits of work.
 - No excess soil, chemicals, debris, equipment or other materials shall be dumped or stored outside the designated limits of work.
 - Upon project completion, areas of exposed soil shall be re-vegetated with locally native erosion control species. Non-native grasses or forbs may not be used for erosion control.
 - Implementation of standard erosion control best management practices and riparian habitat protection measures shall be adhered to prior, during, and after the construction period to minimize impacts to the intermittent drainage.
 - A permanent low split-rail type fence or other permanent barrier shall be installed between protected woodlands and the residential development.
4. To comply with the Santa Cruz County General Plan Policy 5.1.12, restoration of the degraded sensitive habitat associated with the riparian woodland and Wetland 2 shall be required. A site-specific Habitat Restoration Plan shall be developed for restoration of the mapped riparian woodland and Wetland 2 and shall be submitted to Environmental Planning staff for approval prior to implementation.
 - The Habitat Restoration Plan shall be prepared by a qualified professional, and shall include the following minimum elements:
 - Plan for removal of non-native species and a management strategy to control re-establishment of invasive non-native species within the riparian woodland and Wetland 2.

- Species, size, and locations of all restoration plantings. These plantings shall occur at sizes and ratios determined by the restoration specialist to adequately restore native riparian woodland habitat while maximizing plant health and survivability of individual trees and shrubs.
 - Location and methods of installation of permanent split-rail type fence or other permanent barrier around approved protective buffers.
 - Establishment of a designated wetland planting area within the boundaries of Wetland 2 where native hydrophytic plant species and native erosion seed mix specific to wetlands shall be installed.
 - Information regarding the methods of irrigation for restoration plantings.
 - 5-year management plan for maintenance and monitoring of restored areas to maintain 100% survival of installed container stock in years 1-3, and at least 80% survival in years 4-5. Replacement plants shall be installed as needed during the monitoring period to meet survival rates. Annual reports shall be submitted to the County Planning Department by December 31 of each monitoring year.
 - The project developer shall be responsible for execution of the 5-year management plan for maintenance and monitoring of restored areas until the responsibility is transferred legally to another entity such as an HOA. County Environmental Planning Staff shall be informed of any such transfer of responsibility.
 - Work associated with removal of non-native species, installation of native plant stock, and any other restoration activities outlined in the Habitat Restoration Plan shall be conducted with hand tools unless other methods are approved by County Environmental Planning Staff.
 - Establishment and planting of all restoration and mitigation area(s) as outlined in the final approved Restoration Planting Plan shall be inspected and approved by Environmental Planning staff prior to release of securities for the subdivision improvements.
5. If Riparian Exception Findings are met, and encroachment into the 100-foot riparian corridor of Wetland 1 is authorized, the following shall be adhered to:
- The boundaries of Wetland 1 as delineated in the May 2018 Wetland Delineation shall be assumed correct unless additional analysis is conducted. The location and boundary of Wetland 1 shall be flagged in the field by a qualified biologist, based on presence and location of hydrophytic vegetation, and mapped as sensitive habitat.
 - A protective buffer of at least 30 feet around Wetland 1 shall be established (Final buffers would be determined by Riparian Exception Findings). The area within this buffer shall be mapped as sensitive habitat, and no development shall occur within the County approved protective buffer.
 - A permanent low split-rail type fence or other permanent barrier shall be installed between the approved protective buffer of Wetland 1 and the residential development.
 - To compensate for encroachment into the 100-foot riparian corridor, Wetland 1 shall be enhanced by removing non-native species and re-vegetating with native hydrophytic plant species and a native erosion seed mix specific to wetlands.

- Wetland 1 shall be included as part of the site-specific Habitat Restoration Plan, and all elements and conditions of this plan shall apply, including details regarding methods for restoration and monitoring of Wetland 1; location of protective buffers and fences; and species, size, and locations of all restoration plantings.
6. If removal of any oak trees is required as a result of the project, to compensate for impacts resulting from removal of, or damage to, native trees within oak woodlands:
- All permanently impacted areas of oak woodland habitat shall be compensated for at a 1:1 replacement ratio by creating oak woodland habitat in designated mitigation areas on site.
 - All native oak trees removed or damaged during construction shall be replaced in-kind at a minimum 3:1 replacement ratio within designated oak woodland mitigation areas on site.
 - Additional restoration plantings shall occur at sizes and ratios determined by the restoration specialist to establish 1:1 replacement of oak woodland habitat while maximizing plant health and survivability of individual trees and shrubs.
 - Details shall be included in the final site-specific Restoration Planting Plan including establishment of designated oak woodland mitigation area(s) on site to achieve a 1:1 habitat replacement ratio, and minimum 3:1 oak tree replacement ratio within these designated areas.
7. To avoid impacts to nesting birds:
- If removal of vegetation, grading activity, or other use of heavy equipment begins outside the February 1 to August 31 breeding season, there will be no need to conduct a preconstruction survey for active nests.
 - Woody vegetation intended for removal shall be removed during the period of September 1st through January 31st, in order to avoid the nesting season.
 - If removal of vegetation, grading activity, or other use of heavy equipment is to commence between February 1st and August 31st, a survey for active bird nests shall be conducted by a qualified biologist within 15 days prior to the start of such activity. The survey area shall include the project area, and a survey radius around the project area of 50 feet for MBTA birds and 250 feet for birds of prey.
 - If no active nest of a bird of prey or MBTA bird is found then no further avoidance and minimization measures are necessary.
 - If active nest(s) of MBTA birds or birds of prey are found in the survey area, an avoidance buffer of 50 feet for MBTA birds and 250 feet for birds of prey shall be established around the active nest(s). The biologist shall monitor the nest, and advise the applicant when all young have fledged the nest. Removal of vegetation, grading activity, or other use of heavy equipment may begin after fledging is complete.
 - If the biologist determines that a smaller avoidance buffer will provide adequate protection for nesting birds, a proposal for alternative avoidance/protective measures, potentially including a smaller avoidance buffer and construction monitoring, may be submitted to Environmental Planning staff for review and approval prior to removal of vegetation, grading activity, or other use of heavy equipment.

- If removal of vegetation, grading activity, or other use of heavy equipment stops for more than two weeks during the nesting season (February 1st - August 31st) a new survey shall be conducted prior to re-commencement of construction.

By incorporating these conditions, the project will result in no significant impacts to sensitive habitat or species, and will improve the habitat features present on this parcel.

A copy of this biotic approval, including attachments, should be submitted with any future permit applications.

If you have any questions regarding this letter, please feel free to contact me by email or telephone at Juliette.Robinson@santacruzcounty.us or 831-454-3156.

Sincerely,



Juliette Robinson
Resource Planner IV, Biologist

CC: Robert Loveland, Area Resource Planner

**LAKEVIEW ESTATES, TREMBLEY LANE
WATSONVILLE, CA**
APN 051-411-21

RIPARIAN AND WETLAND RESTORATION PLAN

March 10, 2021



Biotic Resources Group

Biotic Assessments ♦ Resource Management ♦ Permitting

LAKEVIEW ESTATES. TREMBLEY LANE WATSONVILLE, CA

APN 051-411-21

RIPARIAN AND WETLAND RESTORATION PLAN

Prepared for:

Eadie Consultants
Attn: Charlie Eadie

Prepared by:

Biotic Resources Group
Kathleen Lyons

March 10, 2021

1.0 INTRODUCTION

This Riparian and Wetland Restoration Plan (Plan) identifies methods for the restoration and enhancement of two Restoration Areas for the parcel located at the terminus of Trembley Lane near Watsonville in unincorporated Santa Cruz County (APN 051-411-20). Restoration Area A encompasses the riparian area associated with Stream 533, Wetland #2, and a 50-foot wide riparian buffer. Restoration Area B encompasses a wetland seep and a 30-foot buffer. The landowner of the parcel, and subsequent Homeowners Association (HOA), will be responsible for implementing this Plan to comply with the County of Santa Cruz's Condition of Approval for the proposed eight lot subdivision. Figure 1 shows the location of the parcel subject to this Plan.

The Plan identifies the location and techniques to be used by the landowner/HOA to enhance and restore the two Restoration Areas through the removal and control of invasive, non-native plant species and planting of native trees, shrubs, and groundcovers. The Plan identifies measures to avoid or minimize impacts to sensitive biological resources within the designated areas during subdivision construction and during Plan implementation. The Plan utilizes an adaptive management process, such that the Plan activities may be adapted over time to achieve the biological goals and objectives. Plan actions include the following:

- **Demarcation of Restoration Areas:** Installation of permanent fencing and signs along the western side of Restoration Area A and around the west, north, and east sides of Restoration Area B. Install fencing and maintenance access gates concurrent with subdivision construction. The fence can be split-rail fence, post and wire, or other fence design; yet the fence should be a minimum of four feet in height. Interpretive signs shall be installed on the fence indicating that the area is a designated habitat restoration and enhancement area and no unauthorized foot or vehicular access is allowed.
- **Invasive, Non-native Plant Control:** Implementation of an integrated pest management approach to remove and control invasive, non-native plant species within the two Restoration Areas. Implement invasive plant control in perpetuity.
- **Revegetation and Management:** Revegetation of riparian/wetland areas and buffers with native trees, shrubs, and groundcovers for habitat enhancement. Provide maintenance and monitoring of revegetated areas for minimum of 5 years.
- **Monitoring:** Implementation of habitat monitoring to evaluate the effectiveness of the Plan actions. Monitor Plan actions for a minimum of 5 years, with annual reporting to Santa Cruz County Planning Department.

1.1 PLAN GOALS AND OBJECTIVES

The Plan includes biological goals and objectives based on the ecology of the sensitive habitats, threats to the habitats, and the potential effects of Plan actions on such resources.

Goal 1: Increase Habitat Values in Restoration A. Install native riparian trees and shrubs to increase habitat value and species diversity, maintain and monitor plantings for 5 years and achieve 5-year performance standards.

Objective 1.1: Engage services of native plant nursery to conduct regional collection of native riparian plant propagules and grow plants for out-planting (container plants) (1-year lead time).

Objective 1.2: Install container plants and locally-collected willow cuttings into designated area; maintain and monitor for 5 years and achieve 5-year performance standards.

Goal 2: Increase Habitat Values in Restoration B. Install native shrubs and herbaceous species to increase habitat value and species diversity, maintain and monitor plantings for 5 years and achieve 5-year performance standards.

Objective 2.1: Engage services of native plant nursery to conduct regional collection of native wetland plant propagules and grow plants for out-planting (1-year lead time).

Objective 2.2: Install grown plants into designated area; maintain and monitor for 5 years and achieve 5-year performance standards.

Goal 3: Remove and Control Invasive, Non-native Plant Species. Within Restoration Areas A and B, remove occurrences of invasive, non-native trees, maintain and monitor occurrences for 5 years and achieve 5-year performance standards.

Restoration Area A

Objective 3.1: In Years 1-3, remove all pampas grass (<10); dispose of all material off-site.

Objective 3.2: In Years 1-5, remove all bull thistle and wild mustard; dispose all above ground material off-site.

Objective 3.3: Yearly, in early summer, mow 10-foot wide strip along western boundary to reduce fuel load and create a defensible space along the fence line.

Restoration Area B

Objective 3.4: In Years 1-3, remove all Himalaya berry, kikuyu grass, and fennel; dispose of all material off-site.

Objective 3.5: In Years 1-5, reduce cover of Harding grass through periodic mowing and hand removal; dispose all above ground material off-site.

Objective 3.6: Yearly, in early summer, mow 10-foot wide strip along west, north, and east boundaries to reduce fuel loads and create a defensible space along the fence line.

Goal 4: Monitor Plan Actions and Report of Progress. Monitor and report to Santa Cruz County on an annual basis Plan actions implemented, goals met, performance standards and remedial actions needed.

Objective 4.1: Document dates and areas of plan implementation.

Objective 4.2: Establish a series of permanent photo-stations to document yearly progress of plan actions.

Objective 4.3: Submit annual reports to County Planning Department by December 31 of each monitoring year, for a period of 5 years, or longer until performance standards are met.

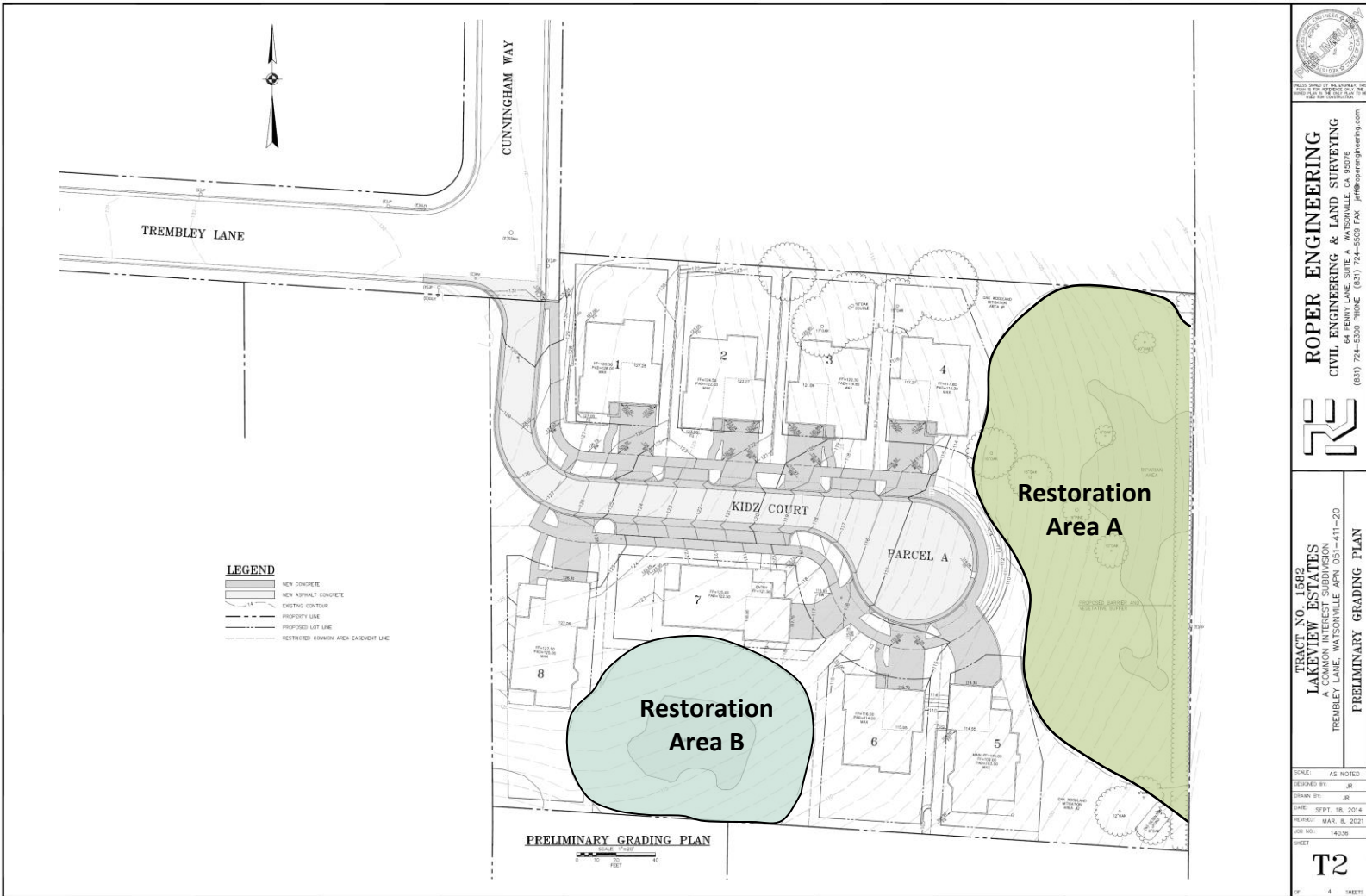

Figure 1. Location of Restoration Areas on Project Grading Plan
 (Map Source: Lakeview Estates Preliminary Grading Plan, Roper Engineering, dated 3-8-21)

1.2 PLAN DEVELOPMENT

1.2.1 Invasive, Non-native Plant Species, Infestation Areas, Threat Rankings, and Control Methods

The occurrence of invasive, non-native plant species within the two Restoration Areas was identified and mapped during field surveys conducted in October 2020. The infestations were identified as polygons or spot locations onto an aerial photo. The 2020 survey documented seven (7) plant species of management concern. Eight (8) polygons were mapped.

A species growth pattern, extent within the Restoration Area(s), effect on native vegetation, and ability to spread into un-infested areas were used to determine which invasive plant species are of management concern. Information on the invasive plant species found on the site and their ranking and threat is described in Section 2.0.

Various control/removal methods were evaluated as to their potential use on site, such as hand pulling, weed whipping, cutting, and herbicide application. Methods that minimize potential impacts to adjacent native vegetation were also considered. Section 2.0 outlines the recommended invasive weed control techniques for each species. A general yearlong schedule outlining the optimum time for implementing treatment is also provided in this section.

1.2.2 Revegetation of Restoration Areas

Opportunities for the revegetation of the two Restoration Areas with native trees, shrubs, and/or groundcovers were identified. Methods for plant establishment were developed. Section 3.0 outlines the revegetation of portions of the two Restoration Areas.

1.2.3 Monitoring and Reporting

The Plan outlines implementation of a 5-year monitoring and reporting program. Field monitoring techniques were evaluated for all Plan actions. Metrics for monitoring were developed with yearly performance standards and final Year 5 standards. Reporting requirements to County Planning Department were also determined. Section 4.0 outlines monitoring and reporting requirements.

2.0 INVASIVE, NON-NATIVE PLANT CONTROL AND REMOVAL

The Plan addresses plant species considered to be of significant management concern within the Restoration Areas. Some of the plant species found within these areas are listed by the California Department of Food and Agriculture (CDFA) and California Invasive Plant Council (Cal-IPC), as *noxious weeds* and *invasive species*. Table 1 lists these species and their Cal-IPC invasive rating.

In general, *noxious weeds* and *invasive plants* are adapted to establish on previously disturbed conditions, such as loose soils exposed by grading or on sites that have experienced a substantial habitat change from previous agriculture, grazing or other activity.

Plants can be annual/biennial species, such as Italian thistle, that grow quickly and produce large amounts of seed. The seeds from annual plants are often easily dispersed by wind or by animals. Perennial plants, such as pampas grass (*Cortaderia jubata*) reproduce by seed. These seeds can persist in the soil for long periods of time. Shrubs, such as Himalaya berry (*Rubus armeniacus*) reproduce by root and stem suckers. The invasive non-native plant species currently of management concern are listed on Table 1.

Figure 2 shows the baseline condition of invasive weeds within the Restoration Areas. These weed occurrences, as well as additional invasive plant species that may be found on site in the future during monitoring, are identified for removal and control as part of this Plan.

Table 1. Invasive, Non-native Plant Species of Management Concern Within the Restoration Areas, Lakeview Estates

Common Name	Scientific Name	Cal-IPC Ranking	Growth Habit
TREES			
Monterey Pine ¹	<i>Pinus radiata</i>	Limited	Perennial
SHRUBS/VINES			
Himalaya Berry	<i>Rubus armeniacus</i>	High	Perennial
GROUNDCOVERS			
Italian thistle	<i>Carduus pycnocephalus</i>	Moderate	Annual
Bull thistle	<i>Cirsium vulgare</i>	Moderate	Biennial
Canary Grass	<i>Phalaris spp.</i>	Moderate	Perennial
Wild Radish	<i>Raphanus sativa</i>	Limited	Biennial
Kikuyu Grass	<i>Pennisetum clandestinum</i>	Limited	Perennial
Fennel	<i>Foeniculum vulgare</i>	High	Perennial

¹ species occurs nearby and may colonize the restoration areas.

Eight (8) polygons of invasive, non-native plants were identified for removal/control within the Restoration Areas in October 2020. The location of the polygons is depicted on Figure 2.

2.1 INVASIVE, NON-NATIVE PLANT SPECIES MANAGEMENT

The management of invasive plants within the Restoration Areas refers to the removal/control of invasive, non-native plant species that have been considered an immediate and/or significant threat to the sensitive habitat (i.e., riparian and wetland). The desired manner for the control of these species is for the landowner/HOA to remove the occurrences. Removal of these plants will also reduce weed seeds that can re-infest the area and surrounding areas. This section describes the various management techniques that can be used and identifies the most effective techniques for each species.

As stated in Section 1.1, the objectives for invasive, non-native plant control are:

Goal 3: Remove and Control Invasive, Non-native Plant Species. Within the Restoration Areas, remove occurrences of invasive, non-native species, maintain and monitor occurrences for 5 years and achieve 5-year performance standards.

Restoration Area A

Objective 3.1: In Years 1-3, remove all pampas grass (<10); dispose of all material off-site.

Objective 3.2: In Years 1-5, remove all bull thistle and wild mustard; dispose all above ground material off-site.

Objective 3.3: Yearly, in early summer, mow 10-foot wide strip along western boundary to reduce fuel load and create a defensible space along the fence line.

Restoration Area B

Objective 3.4: In Years 1-3, remove all Himalaya berry, kikuyu grass, and fennel; dispose of all material off-site.

Objective 3.5: In Years 1-5, reduce cover of Harding grass through periodic mowing and hand removal; dispose all above ground material off-site.

Objective 3.6: Yearly, in early summer, mow 10-foot wide strip along west, north, and east boundaries to reduce fuel loads and create a defensible space along the fence line.

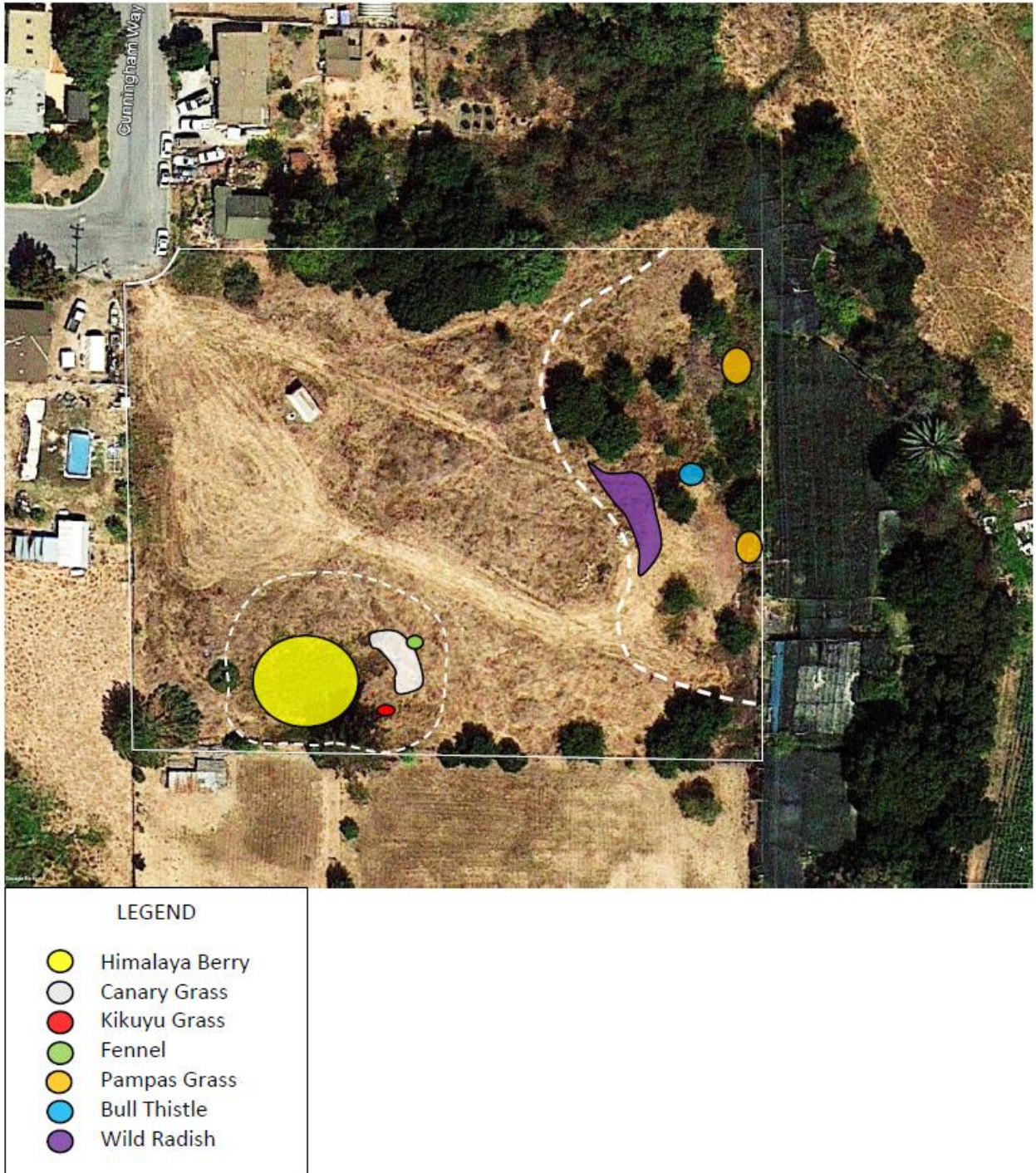

Figure 2. Occurrences of Invasive, Non-native Plant Species for Removal/Control within Restoration Areas, October 2020

2.1.1 General Guidelines and Specifications

The most effective control techniques must take into account a species growth cycle, its flowering period and seed production/release periods, and its occurrence or level of infestation. Although supervision as to timing, technique and general location for invasive plant management can be provided for personnel performing invasive plant fieldwork, a certain level of field training is required for success.

Field training should include, but not be limited to, the follow skills and abilities:

- The ability to identify the key invasive plant species likely to be encountered. Appendix A depicts photos of the current invasive plant species on the parcel.
- The ability to identify native riparian plant species that may be encountered within the work area and should be retained. Appendix B depicts photos of the native riparian plant species that are to be retained.
- Skill with various types of equipment, details of proper techniques and timing to achieve maximum efficiency and success.
- General guidance to limit harm to sensitive resources (see Section 2.1.3).
- Use of adaptive management strategies. Field personnel should be encouraged to consider new ideas and potential improvements based on monitoring the effectiveness and effects of actions implemented on both the targeted species and the habitat, short and long-term.

The techniques to control specific invasive plants are numerous. The various techniques and methods in this Plan have been tailored specifically for the plant species, conditions and locations, within the riparian corridor and setback area are listed in Table 2. Proper training of field personnel is recommended prior to field work, such that the method and technique is correlated to the biology of the species and the surrounding environmental conditions. Additionally, as biological environments are subject to constant dynamic processes, adjustments to method or technique details may be required.

Table 2. Techniques for Removal of Invasive, Non-native Plant Species

Method #	Technique	Guidelines	Applicable Species
1	Hand-work, with hand tools	<ul style="list-style-type: none"> ▪ Hand pull –use hand tools for removal of roots/root crowns ▪ Dispose of above-ground biomass off-site ▪ Conduct removal October – March 	<ul style="list-style-type: none"> ▪ Himalaya berry, removing root crown and major roots; requires 2-3 years of repeated treatment. ▪ Italian Thistle and Bull Thistle (remove rosettes, prior to flowering) ▪ Wild Radish (remove rosettes, prior to flowering) ▪ Kikuyu Grass ▪ Fennel ▪ Pampas Grass
2	Cut and Paint with herbicide	<ul style="list-style-type: none"> ▪ Cut freshly cut stump and paint herbicide to cut stem 	<ul style="list-style-type: none"> ▪ Mature clumps of Himalaya berry, cutting freshly cut stumps
3	Mowing and Weed-Whipping	<ul style="list-style-type: none"> ▪ Conduct early spring mowing/weed whipping to reduce above-ground growth and prevent seed productions 	<ul style="list-style-type: none"> ▪ Canary Grass

2.1.2 Herbicide Guidelines and Restrictions

All herbicide use must follow legal and biological requirements and restrictions for application, cleanup and disposal. Additional considerations include:

- Dye shall be added to herbicide to identify placement
- Herbicide should be new unopened containers and should be mixed on site, at a designated location away from sensitive habitat
- No herbicide shall be used near on in running or standing water
- No herbicide shall be used within 48 hours, before or after a rain event based on the weather forecast
- No herbicide shall be used in proximity to bee colonies or like pollinators

2.1.3 Precautions to Protect Sensitive Biotic Resources

Implementation of some weed management activities has the potential to harm native plant and animal species, if such resources are present in the work area. For example, ground nesting birds can be harmed if they have nests within areas subject to vegetation removal during the bird nesting season. Dens of dusky-footed woodrat can be harmed if weed control activities inadvertently alter these dens. Measures are described in this section on actions to be implemented to avoid impacts to non-target plants and animals.

2.1.3.1 Measures to Minimize Impacts to Breeding Birds and Woodrat Nests. Within the central coast region, the bird-breeding season is typically between March 1 and August 31. All migratory bird nests are protected under the Federal Migratory Bird Treaty Act. Invasive plant removal will be conducted between October and March, which is outside of the bird breeding season.

The Restoration Area A work area should be walked to identify any wood rat houses. Wood rats construct large stick-filled houses that can be several feet tall and wide. All wood rat houses are to be retained, with a minimum 10-foot buffer established around each house. Each den should be flagged and workers notified as to the location of each house. If a weed plant is found to be growing through a house, the stem can be cut and painted at a level above the top of the house. No wood rat houses shall be disturbed without prior written approval from California Department of Fish and Wildlife (CDFW).

2.1.4 Schedule

Removal and control of invasive, non-native plant species will occur in Years 1-5, or longer, if needed to meet performance standards. A schedule for Years 1 -5 is depicted on Table 3.

Table 3. Schedule for Removal of Invasive, Non-native Plant Species, Years 1-5

Task	September	October –March
Years 1-3: Locate mapped occurrences of invasive species as depicted on Figure 2, and others, if detected. Flag any sensitive resources at/near mapped polygons.	■	
Years 1-3: Hand remove all occurrences, Remove material from site. Re-treat previously treated areas, as needed.		■
Years 4-5: Re-treat previously treated areas, as needed		■

3.0 REVEGETATION ACTIVITIES

The County has requested enhancement of the riparian and wetlands area and their buffers. As per Section 1.1, the goals and objectives for this portion of the Restoration Area are:

Goal 1: Increase Habitat Values in Restoration A. Install native riparian trees and shrubs to increase habitat value and species diversity, maintain and monitor plantings for 5 years and achieve 5-year performance standards.

Objective 1.1: Engage services of native plant nursery to conduct regional collection of native riparian plant propagules and grow plants for out-planting (container plants) (1-year lead time).

Objective 1.2: Install container plants and locally-collected willow cuttings into designated area; maintain and monitor for 5 years and achieve 5-year performance standards.

Goal 2: Increase Habitat Values in Restoration B. Install native shrubs and herbaceous species to increase habitat value and species diversity, maintain and monitor plantings for 5 years and achieve 5-year performance standards.

Objective 2.1: Engage services of native plant nursery to conduct regional collection of native wetland plant propagules and grow plants for out-planting (1-year lead time).

Objective 2.2: Install grown plants into designated area; maintain and monitor for 5 years and achieve 5-year performance standards.

3.1 Revegetation Areas

Revegetation is to occur within Restoration Area A (riparian area and buffer) and Restoration Area B (wetland seep and buffer). These Restoration Areas are depicted on Figure 2.

Areas subject to revegetation are areas that currently support grasses and forbs, native blackberry thickets (Restoration Area A), and, in Restoration Area B, areas where invasive, non-native plants will have been removed.

3.2 Plant Installation

In Restoration Area A, native riparian trees and shrubs will be installed as dormant cuttings (willow) and container stock, as listed in Table 4. In Restoration Area B, native shrubs and herbaceous species (container stock) will be used for the revegetation, as listed in Table 4. A conceptual plant layout is presented in Figure 3.

The landowner/HOA will be responsible for contracting with a native plant nursery to do regional collection of plant propagules (i.e., seed/cuttings) and plant propagation. The landowner/HOA will be responsible for contracting with a native plant landscape contractor for installation of the plantings, designing/installing a temporary drip irrigation system, and providing site maintenance.

The typical planting season for container stock is in the fall; however, spring plantings can also occur where there is a reliable irrigation system. The willow stakes will be installed when dormant, which is between December 15 and January 15. All plantings will be irrigated before and after planting and will be serviced with a temporary above-ground drip irrigation system.

Container Stock Installation. Once container stock plantings are delivered to the site, plant installation can proceed. The planting hole should be excavated to the specified dimensions (see Figure 4) and prepared to receive the plant. A root protector cage should then be installed in the planting hole, as gopher activity is expected and plant losses could occur due to gopher browse.

The plant should be carefully removed from its container in order to avoid any root damage and placed in the planting hole/cage. The planting hole is then to be back filled with the native soil and a water basin constructed. An above-ground foliage protector (i.e., deer browse cage) is to then be fitted over the plant. The final step is to apply a three-inch layer of clean wood chip mulch. Plant installation should follow the typical details presented in Figure 4; however, cage sizes will need to be adjusted to accommodate 5-gallon size plants.

Table 4. Plant Palette for Riparian Revegetation Areas

Map Code Figure 3	Common Name	Scientific Name	Propagule Size	Approx. Spacing	Number of Plants
RESTORATION AREA A					
SASP	Willow	<i>Salix lasiolepis</i>	Dormant cuttings/stakes	4"	30
QUAG	Coast Live Oak	<i>Quercus agrifolia</i>	5 gal.	20'	5
QUAG	Coast Live Oak	<i>Quercus agrifolia</i>	1 gal.	20'	5
ACNE	Box Elder	<i>Acer negundo</i>	5 gal.	20'	4
ACNE	Box Elder	<i>Acer negundo</i>	1 gal.	20'	4
Shrub Mix					
FRCA	Coffee Berry	<i>Frangula californica</i>	1 gal.	6'	8
SYAL	Snowberry	<i>Symphoricarpos albus</i>	1 gal.	6'	8
RISA	Flowering Currant	<i>Ribes sanguineum</i>	1 gal.	6'	8
ROCA	California Rose	<i>Rosa californica</i>	1 gal.	5'	8
TOTAL RESTORATION AREA A					80
RESTORATION AREA B					
JUPA	Spreading Rush	<i>Juncus patens</i>	1 gal.	3'	20
SYCH	California Aster	<i>Symphotrichum chilense</i>	1 gal.	6'	25
ROCA	California Rose	<i>Rosa californica</i>	1 gal.	5'	12
TOTAL RESTORATION AREA B					57



LEGEND

Restoration Area A	
●	Coast Live Oak
●	Box Elder
●	Restoration Area A Shrub Mix
●	Willows
Restoration Area B	
●	Spreading Rush
●	California Aster
●	California Rose

Figure 3. Conceptual Revegetation Within Revegetation Areas

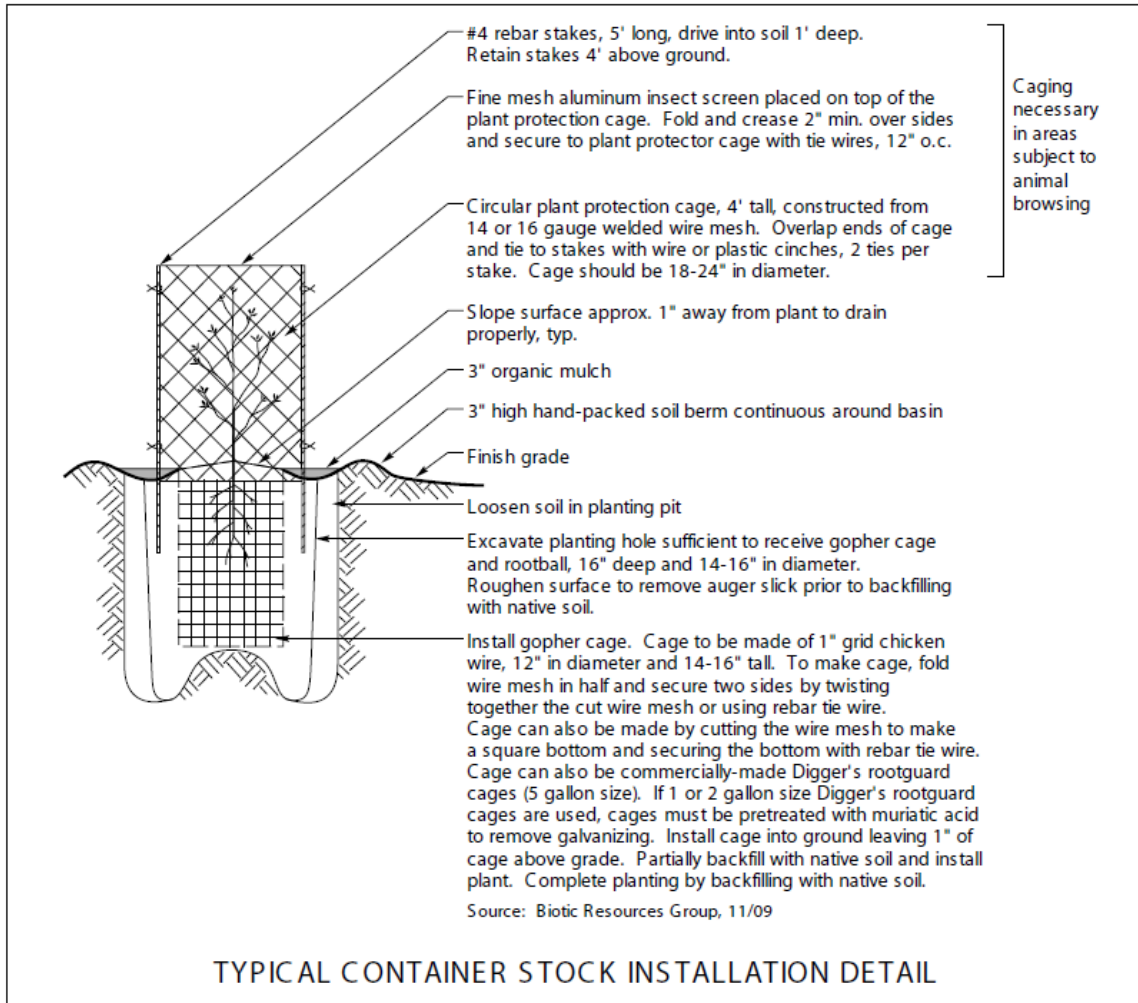

Figure 4. Typical Plant Installation Detail

(Note: adjust sizes to accommodate 5-gallon containers, as needed)

Willow Stake Installation. Willow stakes will be installed on the lower slope, yet upslope and away from the overhead power lines. The willows will be installed between existing oak trees such that a continuous wooded canopy will be created along the creek. Where willows are installed amid existing California blackberry thickets, a 3-foot diameter area of blackberry will be cleared and the willow stakes installed. The stakes will be installed such that 80% of the stake is in the ground. A drip emitter will service each stake. The willow stake detail is depicted in Figure 5.

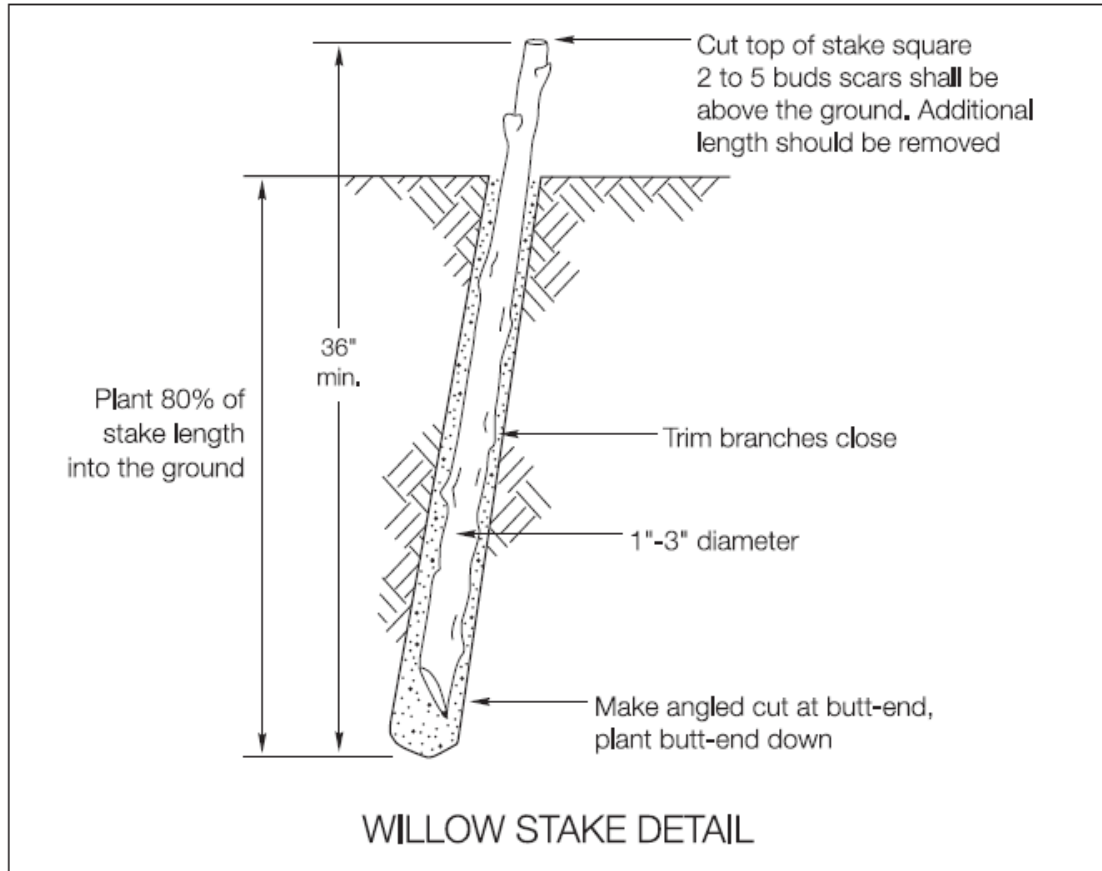

Figure 5. Typical Willow Stake Detail

3.3 Site Maintenance

The plantings will be maintained regularly during a 5-year plant establishment period. Maintenance activities will include supplemental irrigation in Years 1-3, weed control and browse protection. During this period, the landowner/HOA will employ a native plant landscape contractor will perform maintenance activities approximately 1 time per month. This schedule will ensure that plant survival rates are maximized and desired habitat features are achieved. A maintenance schedule for Years 1 -5 is depicted on Table 5.

Typical maintenance tasks during Years 1-5 will include weeding of planting basins, repair/replace animal protection devices, re-application of mulch, repair of watering basins, check/repair of irrigation system, removal of invasive, non-native plant species, and installation of replacement plants (if needed to meet performance standards).

3.3.1 Supplemental Irrigation. Irrigation can be provided by a landscape contractor-built temporary drip system. Watering must be effectively controlled to minimize plant loss and water waste resulting from over watering. It is the responsibility of the landowner to ensure that the plantings receive sufficient water to promote healthy plant growth. The plantings will be irrigated during the first two growing seasons, 1 time per week between May and October (depending upon weather). In Year 3, irrigation should be reduced to twice a month between May and September. Each watering will be of such a quantity as to provide optimum growth conditions. If drought stress or chlorosis (leaf yellowing) is noted on any of the plantings, the quantity and interval of watering will be increased.

If an unusual drought occurs in other months (i.e., less than 70% of normal rainfall between October and May) such that soil moisture drops to a level where plant survival is compromised, supplemental irrigation will be initiated. Supplemental irrigation will be continued until natural rainfall levels replenish soil moisture.

3.3.2 Weed Control. During Years 1-5, competition from weeds and/or invasive, non-native plant species within the planting basins shall be minimized; basin shall be kept weed-free during the growing season; maximum weed height of 6 inches during non-growing season.

3.3.3 Browse Control. During Years 1-5, actions to minimize browse damage on plantings will be implementing by maintaining browse protection devices (i.e. cages) on selected plants so as to maximize plant survival and desired habitat features. Repair and/or replace cages that have been damaged.

Table 5. Revegetation Area Maintenance Schedule

Task	Winter	Spring	Summer	Fall	Winter
<u>Minimum of one year prior to plant installation.</u> Enter into agreement with native plant nursery to collect plant propagules and grow container stock plants.		■			
<u>Year 0.</u> In late fall, after first soaking rains, install plants within revegetation areas, as per conceptual layout and as field-checked by restoration specialist or botanist. Install below and above ground browse protection for container stock. Install dormant willow stakes between December 15 and January 15. Provide irrigation after planting and until natural rains commence.				■	
<u>Years 1-3:</u> May through September, begin supplemental irrigation. At periodic intervals, check plant growth and health. Remove weeds from planting basins, repair cages, replace mulch, if needed. Check irrigation system.		■			
<u>Years 2-5:</u> Install replacement plants if any plants die, to achieve 100% survival each year.				■	
<u>Year 4-5:</u> Discontinue supplemental irrigation. At periodic intervals, check plant growth and health. Remove weeds from planting basins, remove cages, replace mulch, if needed.		■			

4.0 MONITORING AND REPORTING OF PLAN PROGRESS

4.1 ANNUAL MONITORING, YEARS 1-5

Monitoring of the progress of Plan implementation is required. Monitoring will be conducted to document areas of invasive removal, document survival of installed riparian planting, evaluate the effectiveness of management actions and, over time, provide insight on ways to improve habitat restoration and management actions.

The landowner/HOA's botanist, ecologist, or restoration specialist should periodic assess how the invasive plant removal and revegetation is proceeding, and to identify problems or potential problems that may exist, including possible colonization of the site by new weeds and invasive species.

4.1.1 Inspect Invasive Plant Removal

A qualified botanist, ecologist, or revegetation specialist will inspect the invasive plant removal areas at least once a year, for 5 years (or longer if performance standards are not met). The purpose of the inspection will be to assess how the removal work is progressing, identify problems or potential problems that may exist, and identify any new occurrences of invasive species that warrant control. The progress of invasive non-native plant species removal will be ascertained during the inspections and the invasive plant infestation maps updated/annotated as to the polygons treated, timing, and control techniques used.

4.1.2 Inspect Revegetation

A qualified botanist, ecologist, or revegetation specialist will inspect the revegetation area at least once a year, for 5 years (or longer if performance standards are not met). The purpose of the inspection will be to assess how the revegetation and habitat restoration actions are proceeding, and to identify problems or potential problems that may exist. During the inspection, the biologist will look for plant damage, document compliance with Conditions of Approval, and make recommendations to correct any significant problems or potential problems. The inspection visit will also be used to document the need to change or adjust revegetation plan actions (i.e., altering the maintenance schedule, adding extra weed control visits, increasing or reducing the frequency or amount of irrigation water, etc.). All plantings will be monitored as to dead/alive, height, and health/vigor. During Years 1-5, yearly plant survival should be maintained at 80%. If plant survival falls below these thresholds in any year, the inspection will document the number of supplemental container stock planting required to be installed.

4.1.3 Photo Documentation

The landowner/HOA's botanist, ecologist, or restoration specialist should photograph the Restoration Area to record the progress of invasive plant removal and revegetation. Photo stations should be established in Year 1 that can be used in Years 1-5 to depict the before and after work efforts and to create a photo record of the progress of the restoration plan. Photo-stations should be established prior to work (Year 1) and photos will be taken from the same vantage point and in the same direction every year.

4.1.4 Success Criteria and Yearly Performance Standards

The final success criteria for the restoration plan are outlined in Table 6. When these criteria are fulfilled, the area will be determined to be progressing toward the habitat type and values that constitute the long-term goals of this project. These final success criteria will be monitored for compliance at the end of the 5-year monitoring period. Final success criteria for the Restoration Area will be documented by monitoring by a qualified botanist, ecologist or revegetation specialist.

Performance standards are established for the Restoration Area. These are measured during Years 1-5 as the areal extent of invasive, non-native plant species. This will be determined by the number and extent of polygons supporting invasive, non-native plant species. Within the revegetation area, survival of installed plantings and overall site maintenance will be monitored.

Remedial measures will be implemented by the landowner if these standards are not achieved in any of the monitoring years. Examples of remedial actions include re-planting failed plants, increasing weeding sessions, supplemental planting, additional control of invasive plant species, and/or modifying the irrigation system.

Table 6. Performance Standards for Years 1-4 and Final Success Criteria for Year 5

	Year 1	Year 2	Year 3	Year 4	Year 5
Restoration Area A					
# of Polygons of Invasive Weeds	2	2	2	1	0
Maximum Cover of Invasive, Non-native Plant Species (%)	<10	<10	<5	<5	<5
Revegetation Plant Survival (%)	80%	80%	80%	80%	80%
Number of Surviving Plant by Species					
Willow	24	24	24	24	24
Coast Live Oak	8	8	8	8	8
Box Elder	8	8	8	8	8
Coffee Berry	6	6	6	6	6
Snowberry	6	6	6	6	6
Flowering Currant	6	6	6	6	6
California Rose	6	6	6	6	6
Total Plants	64	64	64	64	64
Restoration Area B					
# of Polygons of Invasive Weeds	2	2	2	1	0
Maximum Cover of Invasive, Non-native Plant Species (%)	<40	<40	<25	<10	<5
Revegetation Plant Survival (%)	80%	80%	80%	80%	80%
Number of Surviving Plant by Species					
Spreading Rush	16	16	16	16	16
California Aster	20	20	20	20	20
California Rose	10	10	10	10	10
Total Plants	46	46	46	46	46

4.2 REPORTING

Annual reports for monitoring Years 1-5 will present data on the mitigation area(s), actions implemented, the attainment of yearly target criteria, progress toward final success criteria, and any remedial actions required. Reports will be prepared by a qualified botanist, ecologist, or revegetation specialist; the landowner will be responsible for submitting the reports to the County Planning Department by December 31 of each monitoring year.

Cultural Resources Assessment of Proposed Construction at APN 051-411-20, Watsonville, California

Prepared for Raeid Farhat



ALBION
APRIL 2018 FINAL

Cultural Resources Assessment of Proposed Construction at APN 051-411-20, Watsonville, California

April 2018 FINAL
J2018-019...
Photo Credit: Christina Spellman

Prepared for

Raeid Farhat c/o
Charles Eadie
877 Cedar Street, Suite 248
Santa Cruz, California 95060

Prepared by

Stella D'Oro, MA, RPA

Albion Environmental, Inc.
1414 Soquel Avenue, Suite 205
Santa Cruz, California 95062

Executive Summary

In March 2018, Raeid Farhat contracted with Albion Environmental, Inc. (Albion), to conduct a cultural resources assessment of an approximately 2.3-acre parcel (APN 051-411-20) located in Watsonville, California. The property owner plans to construct a subdivision to include a cul-de-sac and nine residences. Albion's investigation included a background records search at the California Historical Resources Information System Northwest Information Center at Sonoma State University (NWIC), and a field investigation entailing pedestrian survey and limited subsurface testing of the parcel. The study was designed to adequately address treatment of cultural resources under current outlined in section 4.9 of the Cultural Resources Element of the Santa Cruz County's General Plan, and current California Environmental Quality Act (CEQA) guidelines.

A search of records at NWIC indicated that one archaeological study has been conducted within the Project Area and eleven studies were conducted within a 100-foot radius of the Project. No archaeological resources have been identified within the Project and two resources have been recorded within a ¼-mile radius of the Project Area.

After reviewing the record search results, Albion conducted an intensive pedestrian survey and limited subsurface testing of the project site. No cultural materials were noted during the surface investigation of the subject parcel. Three trenches were mechanically excavated to expose subsurface deposits and this investigation exposed one chunk of concrete and one shard of clear Coca-Cola bottle glass. Given these findings, it is Albion's judgement that the subject parcel does not contain intact cultural resources and Albion therefore recommends that no further action regarding cultural resources at this parcel is warranted.

Since many important cultural resources, such as Tribal Cultural Resources, do not necessarily leave an archaeological footprint or have physically identifiable manifestations, it is vital to seek out the possibility of these important resources and their locations through consultation with local tribal members. Under the authority of recently-passed Assembly Bill 52, the County of Santa Cruz may have received information from interested Native American tribes or representatives concerning Tribal Cultural Resources at the project site. The County is responsible for collecting and incorporating tribal information into the environmental review process. At this time, we do not know if the County has received any such information.

It is CEQA policy should prehistoric or historic-era deposits or features be discovered at any time during construction, activities in the area should cease and a qualified archaeologist should inspect and evaluate the discovery and prepare a recommendation for a further course of action.

Conclusions and Recommendations

6

Visual inspection of the Project Area surface and small-scale subsurface excavations revealed no evidence of intact prehistoric or historic-era archaeological deposits. According to historic maps and historic aerial images, the Project Area has only been used for agricultural purposes.

Soils encountered were clay loam with no evidence of culturally-produced stratigraphy. No cultural materials were noted during a surface investigation of the subject parcel. Three trenches were mechanically excavated to expose subsurface deposits. This investigation exposed no definitive cultural material and only produced one chunk of concrete and one shard of clear Coca-Cola bottle glass.

Since many important cultural resources, such as Tribal Cultural Resources, do not necessarily leave an archaeological footprint or have physically identifiable manifestations, it is vital to seek out the possibility of these important resources and their locations through consultation with local tribal members. Under the authority of recently-passed Assembly Bill 52, the County of Santa Cruz may have received information from interested Native American tribes or representatives concerning Tribal Cultural Resources at the project site. The County is responsible for collecting and incorporating tribal information into the environmental review process. At this time, we do not know if the County has received any such information.

Albion's investigation at APN 051-411-20 in Santa Cruz County indicates that potentially significant cultural materials are NOT located in the Project Area, and it is Albion's judgment that no further archaeological investigation is warranted to assess California Register of Historical Resources eligibility.

It is CEQA policy should prehistoric or historic-era deposits or features are discovered at any time during construction, activities in the area should cease and a qualified archaeologist should inspect and evaluate the discovery and prepare a recommendation for a further course of action.

Easton Geology, Inc.
P.O. Box 3533, Santa Cruz, CA 95063
831.247.4317 info@eastongeology.com



GEOLOGIC INVESTIGATION

Farhat Property

Trembley Lane
Watsonville, California
Santa Cruz County APN 051-411-20

This report details the findings from our geologic investigation of the above-referenced property.

Easton Geology Job No. G15021
9 December 2016





EASTON GEOLOGY, INC.
P.O. Box 2502, Watsonville, CA 95076
Info@eastongeology.com
831.247.4317

9 December 2016

Raeid Farhat
734 E. Lake Avenue, Ste. 9
Watsonville, California 95076

Job No. G15021

Re: Geologic Investigation
Farhat Property
Trembley Lane
Watsonville, California
Santa Cruz County APN 051-411-20

Dear Mr. Farhat:

We are pleased to present the findings from our geologic investigation of your property situated on Trembley Lane in Watsonville, California. A nine parcel subdivision is proposed for the property, which lies partially within the County and State fault zones designated for the Zayante fault. A single-family home and attached accessory dwelling unit (ADU) is proposed for each resulting parcel. The focus of our work was to determine if seismically-induced lateral spreading has or may potentially occur on the parcel, the extent of any deformation, and suitable mitigation strategies for the proposed residential improvements. We also evaluated the potential for traces of the nearby Zayante fault to transect the property. As a result of this investigation we have developed a geologically feasible building envelope for the proposed development. We worked closely with the project geotechnical engineers during the course of our investigation to help develop mitigation strategies for the identified geologic hazards. Residential development of the proposed subdivision is geologically feasible provided the recommendations of this report and those of the project geotechnical engineer are closely followed.

Please contact us if you have any questions regarding this report.

Sincerely,

EASTON GEOLOGY, INC.

Gregory Easton
Principal Geologist
C.E.G. No. 2502

Copies: Addressee (3)
Rock Solid Engineering, attn: Yvette Wilson (1 + pdf)

TABLE OF CONTENTS

INTRODUCTION	1
REGIONAL GEOLOGIC SETTING	1
REGIONAL SEISMIC SETTING.....	2
San Andreas Fault.....	2
Monterey Bay-Tularcitos Fault Zone.....	3
Calaveras Fault	4
Zayante-Vergeles Fault.....	4
DESCRIPTION OF SITE AND VICINITY.....	5
Geomorphology	5
Earth Materials and Geologic Structure.....	5
Subsurface Investigation.....	6
Aerial Photographic and LiDAR Interpretation.....	8
GEOLOGIC HAZARDS	8
Fault Ground Surface Rupture	8
Seismic Shaking.....	9
Table 1 – Modified Mercalli Intensity Scale	10
Deterministic Seismic Shaking Analysis.....	11
Table 2 – Faults, Earthquakes and Deterministic Seismic Shaking Data	12
Erosion	12
Slope Stability.....	12
Liquefaction and Lateral Spreading Analysis.....	12
CONCLUSIONS.....	13
RECOMMENDATIONS	15
INVESTIGATION LIMITATIONS	15
REFERENCES	17
APPENDICES	
Appendix A – Figures 1 thru 6	22
Figure 1: Site Location Map.....	23
Figure 2: Regional Geologic Map	24
Figure 3: Local Geologic Map.....	25
Figure 4: Local Fault Map.....	26
Figure 5: Alquist-Priolo Earthquake Fault Zone Map.....	27
Figure 6: LiDAR and Air Photo Interpretation Map	28
Appendix B: Scale of Acceptable Risks from Geologic Hazards.....	29
PLATES:	
Plate 1: Site Geologic Map	Pocket
Plate 2: Logs of Exploratory Trench 1.....	Pocket
Plate 3: Logs of Exploratory Trenches 2 and 3.....	Pocket
Plate 4: Log of Exploratory Trench 4	Pocket
Plate 5: Log of Exploratory Trench 5 and Geologic Cross Section A-A'	Pocket

INTRODUCTION

This report presents the results of Easton Geology, Inc.'s geologic investigation of the Farhat property in Santa Cruz County, California (APN 051-411-20). Accessed from Trembley Lane, the flat to gently sloping parcel is situated near the headwaters of College Lake (Figure 1; Site Location Map). The parcel was at one time an orchard but has lain dormant for about 60 years. Current development plans propose subdividing the property into nine parcels and constructing a single-family residence and attached ADU on each resultant parcel. The primary geologic concerns at the property are seismic shaking, liquefaction and lateral spreading, and erosion.

The scope of work performed for this investigation included 1) review of published and unpublished literature relevant to the site and vicinity; 2) analysis of stereo-aerial photographs and LiDAR data; 3) geologic mapping of the site; 4) excavation and logging of five exploratory trenches; 5) coordination with the project geotechnical engineer; 6) compilation and analysis of the resulting data; and 7) preparation of this report and accompanying illustrations, including a geologic map and cross-section.

We reviewed subsurface data collected by the project geotechnical engineer as well as selected subsurface information collected by an earlier geologist for the project.

REGIONAL GEOLOGIC SETTING

The subject parcel is situated upon an elevated fluvial terrace. Locally, the terrace is dissected by several small drainages which flow into College Lake, which occupies a structural basin within the Zayante fault zone. The main trace of the Zayante fault trends northwesterly through the subject area, just southwest of the parcel. The fluvial sediments underlying the site were deposited by the ancestral Pajaro River during the Pleistocene and uplifted through both local and regional tectonism. The tectonics of the region are also responsible for the formation of the Santa Cruz Mountains.

The Santa Cruz Mountains are formed by a series of rugged, linear ridges and valleys following the pronounced northwest to southeast structural grain of central California geology. Contrasting basement rock types which underlie the Santa Cruz Mountains are separated by the northwest-trending San Andreas fault zone. Underlying the mountains southwest of the San Andreas fault is a large, elongate prism of granitic and metamorphic basement rocks, known collectively as the Salinian Block. Northeast of the fault, the mountains are underlain by several structural blocks of metamorphosed basement rock consisting of either the Franciscan Complex, Coast Range Ophiolite, or parts of the Great Valley Sequence. The basement rock southwest of the San Andreas fault is overlain by a sequence of Mesozoic and Cenozoic era marine sedimentary rocks (Figure 2; Regional Geologic Map).

Throughout the Cenozoic Era, this portion of California has been dominated by tectonic forces associated with lateral or "transform" motion between the North American and Pacific crustal plates, producing long, northwest-trending faults such as the San Andreas and San Gregorio faults, with horizontal displacements measured in tens to hundreds of miles. Accompanying the northwest-southeast trending, dextral strike-slip movement of the plates were episodes of compressive stress, causing repeated uplift, deformation, erosion, and subsequent redeposition of sedimentary rocks. Near the crest of the Santa Cruz Mountains, this tectonic deformation is most

evident in sedimentary rocks older than the middle Miocene and consists of steeply dipping folds, overturned bedding, faulting, jointing, and fracturing. Along the coast, the ongoing tectonic activity is most evident in the formation of a series of uplifted marine terraces. The Loma Prieta earthquake of 1989 and its aftershocks are the most recent reminders of the geologic unrest in the region. The seismicity of the area is influenced primarily by the northwest-trending San Andreas fault located northeast of the subject property (Figure 2). The seismicity of the site will be discussed in more detail below.

REGIONAL SEISMIC SETTING

California's broad system of strike-slip faulting has a long and complex history. Several regional faults present seismic hazards to the subject property. The most important of these are the San Andreas, Monterey Bay, Calaveras, and Zayante-Vergeles fault zones (Figure 2). These faults are either active or considered potentially active (Buchanan-Banks et al., 1978; Burkland and Associates, 1975; Jennings et al., 1975; Greene, 1977; Hall et al., 1974; Schwartz et al., 1990; Wallace, 1990; Working Group on Northern California Earthquake Potential [WGNCEP], 1996); and Working Group on California Earthquake Potential, 2008. Each fault is discussed below. The intensity of seismic shaking that could occur at the site in the event of a future earthquake on one of these faults will be discussed in a later section.

San Andreas Fault

The San Andreas fault is active and represents the major seismic hazard in northern California (Jennings et al., 1975; Hall et al., 1974; and Bryant and Lundberg, 2002). The main trace of the San Andreas fault trends northwest-southeast and extends over 700 miles from the Gulf of California through the Coast Ranges to Point Arena, where the fault extends offshore.

Geologic evidence suggests that the San Andreas fault has experienced right-lateral, strike-slip movement throughout the latter portion of Cenozoic time, with a cumulative offset of hundreds of miles. Surface rupture during historical earthquakes, fault creep, and historical seismicity confirm that the San Andreas fault and its branches, the Hayward, Calaveras, and San Gregorio faults, are all active today.

Historical earthquakes along the San Andreas fault and its branches have caused significant seismic shaking in the Santa Cruz County area. The two largest historical earthquakes on the San Andreas to affect the area were the moment magnitude (M_w) 7.9 San Francisco earthquake of April 18, 1906 (actually centered near Olema) and the M_w 6.9 Loma Prieta earthquake of October 17, 1989. The San Francisco earthquake caused severe seismic shaking and structural damage to many buildings in Santa Cruz County. The Loma Prieta earthquake appears to have caused more intense seismic shaking than the 1906 event in localized areas of the Santa Cruz Mountains, even though its regional effects were not as extensive. There were also significant earthquakes in northern California along or near the San Andreas fault in 1838, 1865, and possibly 1890 (Sykes and Nishenko, 1984; WGNCEP, 1996).

Geologists have recognized that the San Andreas fault system can be divided into segments with earthquakes of different magnitudes and recurrence intervals (Working Group on California Earthquake Probabilities, 1988 and 1990). A study by the WGNCEP in 1996 redefined the segments and the characteristic earthquakes for the San Andreas fault system in northern and

central California. Two overlapping segments of the San Andreas fault system represent the greatest potential hazard to the subject property. The first segment is defined by the rupture that occurred from Cape Mendocino to San Juan Bautista along the San Andreas fault during the great 1906 M_w 7.9 earthquake. The WGNCEP (1996) has hypothesized that this "1906 rupture" segment experiences earthquakes with comparable magnitudes in independent cycles about two centuries long.

The second segment is defined by the rupture zone of the M_w 6.9 Loma Prieta earthquake, despite the fact that the oblique slip and depth of this event does not fit the ideal of a typical, right-lateral strike-slip event on the San Andreas fault. Although it is uncertain whether this "Santa Cruz Mountains" segment has a characteristic earthquake independent of great San Andreas fault earthquakes, the WGNCEP (1996) assumed an "idealized" earthquake of M_w 7.0 with the same right-lateral slip as the 1989 Loma Prieta earthquake and a multi-segment recurrence interval of 400 years, and the WGCEP (2008) has determined that the San Andreas – Santa Cruz Mountains Section has a recurrence interval of about 190 years. Field et al. (2014) determined that the Santa Cruz Mountains Section of the San Andreas fault has about a 16% probability of generating an M_w 6.7 or greater earthquake in the next 30 years.

Aagaard, et al., (2016) determined that a given segment of the San Andreas fault within the San Francisco Bay region has a 22% probability of generating an M_w 6.7 or greater earthquake in the next 30 years.

Monterey Bay Fault Zone

The Monterey Bay fault zone is a 6 to 9 mile wide, 25 mile long zone of short, northwest-striking en echelon faults trending between the San Gregorio fault zone and the Seaside-Monterey area in the southern Monterey Bay (Bryant, 2001). The Monterey Bay fault zone is part of the larger Monterey Bay-Tularcitos fault zone which extends 50 miles southeast from the San Gregorio fault to near the crest of the Sierra de Salinas range. Other faults within the greater fault zone include the Navy, Reliz, Tularcitos, and Chupines faults. These faults exhibit evidence of possible late Quaternary and Holocene age right-lateral slip. Geomorphic expression of the Monterey Bay fault zone is revealed by fault strands offsetting the seafloor of southern Monterey Bay.

Seismically, the Monterey Bay-Tularcitos fault zone may be historically active. The largest historical earthquakes *tentatively* located in the Monterey Bay-Tularcitos fault zone are two events, estimated at 6.2 on the Richter Scale, in October 1926 (Greene, 1977). Because of possible inaccuracies in locating the epicenters of these earthquakes, it is possible that they actually occurred on the nearby San Gregorio fault zone (Greene, 1977).

Petersen et al. (1996) calculated an M_w 7.1 earthquake for the Monterey Bay-Tularcitos fault zone with a recurrence interval of 2,841 years and a slip rate of about 0.5 millimeters per year. Field et al. (2014) determined that the Monterey Bay-Tularcitos fault zone has about a 1% probability of generating an M_w 6.7 or greater earthquake in the next 30 years.

Calaveras Fault Zone

The Calaveras fault is a zone of active faults which trend southeast along the eastern side of the East Bay Hills, along the eastern margin of the Santa Clara Valley, extend through the Hollister Valley, and eventually join the San Andreas fault zone (Bryant and Cluett, 1999). The Calaveras fault is about 94 miles long and consists of 4 sections: the Northern, Central, Southern and Paicines sections. The sections exhibit evidence of recent right-lateral surface fault creep as well as historic ground rupture during moderate earthquakes. Geomorphic features such as deflected, offset, and beheaded drainages, linear scarps and troughs, and closed depressions.

Two recent earthquakes which occurred on the Central Calaveras section are the M_w 5.8 Coyote Lake earthquake in 1979, and the 1984 M_w 6.3 Morgan Hill earthquake. Minor ground surface rupture was associated with both of these earthquakes (Bryant and Cluett, 1999).

Petersen et al. (1996) calculated an M_w 6.8 for the northern and an M_w 6.2 for the southern portion of the Calaveras fault. Bryant and Cluett (1999) suggest earthquake recurrence intervals between 125 and 850 years along the Calaveras fault zone. Aagaard et al. (2016) has determined that the Calaveras fault zone has a probability 26% for generating an M_w 6.7 or greater earthquake in the next 30 years.

Zayante-Vergeles Fault

The Zayante-Vergeles fault extends between the San Gregorio and San Andreas faults. The Zayante fault branches from the San Gregorio fault just north of Año Nuevo and trends about 55 miles southeast where it merges with the San Andreas fault south of San Juan Bautista (Bryant, 2000).

The Zayante fault has a long, well-documented history of vertical movement (Clark and Reitman, 1973), probably accompanied by right-lateral, strike-slip movement (Hall et al., 1974; Ross and Brabb, 1973). Stratigraphic and geomorphic evidence indicates the Zayante fault has undergone late Pleistocene and Holocene movement and is potentially active (Buchanan-Banks et al., 1978; Coppersmith, 1979). In the subject area, the Zayante-Vergeles fault has reportedly offset the Watsonville Terrace deposits between 30 and 50 feet vertically.

Some historical seismicity may be related to the Zayante fault (Griggs, 1973). For instance, the Zayante fault may have undergone sympathetic fault movement during the 1906 earthquake centered on the San Andreas fault, although this evidence is equivocal (Coppersmith, 1979). Seismic records strongly suggest that a section of the Zayante fault approximately 3 miles long underwent sympathetic movement in the 1989 earthquake. The earthquake hypocenters tentatively correlated to the Zayante fault occurred at a depth of 5 miles; no instances of surface rupture on the fault have been reported.

In summary, the Zayante-Vergeles fault should be considered potentially active. Bryant (2000) concludes it capable of generating a magnitude M_w 7.1 earthquake with an effective recurrence interval of about 3,000 years. Field et al. (2014) determined that Zayante-Vergeles fault has about a 0.1% probability of generating an M_w 6.7 or greater earthquake in the next 30 years.

DESCRIPTION OF SITE AND VICINITY

The Site Location Map (Figure 1), Local Geologic Map (Figure 3), Local Fault Map (Figure 4), Alquist-Priolo Earthquake Fault Zone Map (Figure 5), LiDAR and Air Photo Interpretation Map (Figure 6), Site Geologic Map (Plate 1), Geologic Cross Section (Plate 5) and Logs of Trenches (Plates 3 thru 5) depict the relevant topographic and geologic information on the subject property.

Geomorphology

The subject property is situated upon the upper slope of a dissected fluvial terrace. The flat-topped terrace was created by the combined processes of localized faulting, regional tectonic uplift, and erosion over perhaps a hundred thousand years. The flat to gently sloping terrain of the elevated terrace has been modified over several tens of thousands of years by stream incision, shallow landsliding, and seismically-induced liquefaction and associated lateral spreading.

A small perennial stream curves around the toe of the slope below the eastern portion of the parcel, and an ephemeral stream channel passes below the southwest property corner and joins the aforementioned stream to the south-southeast (Figure 6). These stream channels were likely tens of feet deeper during the most recent glacial maximum (approximately 15,000 years ago) and have subsequently backfilled due to post-glacial sea level rise. Today the maximum relief of the slope below Trembley Lane is about 40 feet through the property, with a total slope relief of up to 50 feet (Figure 6).

A steeper slope immediately north of the subject parcel is likely the result of shallow landsliding where the aforementioned perennial stream incises the toe of the slope. The right margin of this broad landslide headscarp roughly parallels the northern property line (Figure 6).

The Zayante fault zone trends northwest-southeast, immediately southwest of the subject parcel (Figure 5). Vertical displacement across the Zayante fault has gradually lowered the region northeast of the fault, including the subject property, relative to the southwest side. With the long recurrence interval of the Zayante-Vergeles fault and long-term regional uplift and erosion of the area, fault-related surface morphology is little preserved and for the most part has been eroded and overprinted by slope and soil-forming processes.

Earth Materials and Geologic Structure

The earth materials underlying the subject property consist of the fluvial facies of the Terrace Deposits of Watsonville, a Pleistocene aged (approximately 80,000 to 125,000 years old) river deposit consisting of interbedded clays, silts, sands and gravels (Figure 3). These stratified river deposits are relatively flat-lying in the vicinity of the subject site. Our observations of the earth materials at the site are in general agreement with the geologic mapping by Dupre (1975) (Figure 3).

Exploratory trenches excavated and logged by our firm on the subject property encountered fluvial deposits consistent with the Terrace Deposits of Watsonville to the depths explored. The fluvial deposits encountered in our trenches consisted generally of light gray to dark yellowish brown,

noncemented, interbedded clays, silts, sands and gravels. These riverine deposits tend to be of variable thickness and laterally discontinuous. The sedimentary layers in the trenches were generally horizontal; however, the bedrock has been locally deformed and tilted as a result of liquefaction and lateral spreading. Exploratory borings advanced by the project geotechnical engineer penetrated similar fluvial deposits at depth. We will discuss liquefaction and lateral spreading on the subject site in a following section.

Subsurface Investigation

We excavated five exploratory trenches in the eastern half of the parcel to examine the underlying geologic materials and structure of the site. We also reviewed the log of Trench 1 by Craig Harwood, the former geologist for the project. Harwood's Trench 1 was excavated between the southwest and northeast corners of the parcel as part of an investigation of the nearby Zayante fault (Plate 1). Our trenches were excavated perpendicular to slope in the locations depicted on Plate 1. The trenches revealed interbedded fluvial deposits with traceable, primary stratigraphy throughout. Bedding was generally horizontal, except where locally deformed. In the lower portions of the trenches, the exposed units were generally finer grained than the coarser units above. The contact between a prevalent clay bed and overlying gravelly sands indicates a hiatus in deposition and change in the depositional regime. We did not see significant disturbance of the soil profile in the trenches as a result of historic agricultural or grading practices.

The trenches logged by our firm all revealed the presence of liquefaction-induced settlement and lateral spreading. A few of the trenches revealed offset or thickened soil horizons where underlain by zones of significant liquefaction related deformation. Measured soil offsets were up to six inches vertically. Shears offsetting bedrock were vertical to steeply dipping and exhibited a normal sense of displacement. While cumulative bedrock offsets in our trenches measured up to three feet vertically (in Trench 3), it is important to note that the displacements were much greater than the corresponding offset of an overlying soil horizon. This suggests that repeated liquefaction and lateral spreading events at the site have incrementally displaced the stratigraphic units, with only the most recent liquefaction event preserved in the soil profile: long-term erosion of the slope has eradicated older offset and thickened soils. We also noted during our subsurface investigation that coarser grained channel deposits infilled areas downdropped as a result of liquefaction and lateral spreading. The presence of these channel infills implies that liquefaction and lateral spreading has likely occurred at the subject site for tens of thousands of years. Following is a summary of the features and materials observed in our exploratory trenches:

Trench 1, excavated in the southwestern portion of the parcel, revealed offset primary stratigraphy indicative of extensional ground movement. Vertical to steeply dipping shears offset bedding throughout the trench (Plate 2). Typical offsets were about six inches vertical and two inches horizontal, with a maximum vertical offset of 1.2 feet. We measured approximately 1.25 feet of cumulative horizontal extension along 13 feet of the most disturbed portion of the trench (about an inch of extension per lineal foot). We saw no distinct offsets of the ground surface or soil horizons associated with underlying shears. Abundant sand-filled fissures resulting from liquefaction were noted throughout the trench, especially where an overlying stiff, impermeable clay unit (Unit 3C) overlies sandier units. We also observed that a sandier unit (Unit 3D) thickened and thinned across a zone of significant liquefaction-induced disturbance. The

overlying clay (Unit 3C), deposited horizontally, is now warped, pinching, and swelling (Plate 2). We encountered groundwater in the downslope end of the trench.

We excavated Trench 2 parallel to, and as an uphill extension of Trench 1. The two trenches overlapped by about 12 feet, with the logged wall of Trench 2 inset about a foot deeper than that of Trench 1 which had been backfilled at the time Trench 2 was excavated. Most noteworthy in Trench 2 was that Unit 3C was sharply offset where the two trenches overlapped (Plate 3), whereas in Trench 1 Unit 3C was observed to be only strongly warped (Plate 2). We also noted that the soil horizons above the sheared clay unit were correspondingly offset (Plate 2). The A and B soil horizons were vertically offset about 4 inches and perhaps up to 12 inches, respectively, above the offset clay unit.

We excavated Trench 3 in the northeast corner of the property across a step in the ground surface identified during our site reconnaissance and air photo analysis (Plate 1). Trench 3 revealed a large infilled graben near its downslope end, roughly consistent with the step in topography. We measured bedrock offset up to three vertical feet in the graben (Plate 3). Corresponding offsets of the surface soils spanning the graben were indistinct but may have thickened by about seven inches. Horizontal extension across individual shears was less than three inches. We noted thin (0.1 inch wide) sand-filled liquefaction-induced fissures extending beneath the floor of the upslope portion of the trench. The graben encountered in Trench 3 is approximately 25 feet from any currently proposed structures. We encountered groundwater in the downslope end of the trench.

Trench 4, excavated in the eastern portion of the parcel, revealed minor amounts of extension (Plate 4). Offsets across individual shears were up to 0.5 feet vertical and 0.3 feet horizontal. Thin fissures infilled by liquefied sand were noted in the trench. We encountered groundwater in the downslope end of the trench.

We excavated Trench 5 in the southern portion of the parcel. The trench revealed extensional offsets similar in appearance and magnitude to the extensional features we observed in Trenches 1 & 2. A bed of stiff clay (Unit 3C) was broadly downwarped up to 2.5 feet in several places along the trench wall where the underlying sand or other liquefiable materials have liquefied out (Plate 5). Gravelly channel lag deposits (Unit 3B) were conspicuous within the bottoms of these downwarped areas. We also noted a six inch thickening of the soil profile above some of the downwarps. In several locations across the trench wall, we measured several zones where numerous vertical, soil-filled extensional cracks were present, noting their widths. We measured a maximum $\frac{3}{4}$ inch of extension per foot near the downslope end of Trench 5.

We reviewed the trench log completed by geologist Craig Harwood for any evidence suggesting that tectonic faults may transect the parcel. Harwood's Trench 1 depicts interbedded fluvial terrace deposits similar to those encountered in our exploratory trenches. While the log of Harwood's Trench 1 showed limited detail and questionable interpretations, any fault-related offsets exposed in the trench should have been fairly obvious to the geologist.

We saw no tectonic-related offsets in the subsurface materials exposed in our exploratory trenches, nor did we interpret from Harwood's log that any faulting was encountered in his trench.

During our data compilation and analysis, we projected subsurface information onto a geologic cross section through the proposed development site (Plate 5). We interpret the observed offsets in the exploratory trenches to sole out within a liquefiable layer or zone at depth. A suspect liquefiable layer was encountered in cone penetrometer test borings CPT-2 and CPT-3 at an elevation of approximately 95 feet (Plate 5). This elevation is roughly 15 feet above the incised stream channel at the base of the slope southeast of the parcel and suggests that future liquefaction-induced lateral spreading at the site could occur at or above this 95 foot elevation. We noted that the amount of liquefaction and lateral spread related deformation in the trenches generally decreased upslope, especially in exploratory trenches 2 and 5.

Aerial Photographic and LiDAR Interpretation

We analyzed eight sets of large-scale stereo aerial photographs as well as Light Distance and Ranging (LiDAR) data covering the subject area. The earliest photographs of the site in 1935 show the parcel planted with orchard trees.

During our analysis we identified a well-defined, northwest-southeast trending tonal lineament approximately 400 southwest of the subject parcel. The lineament, presumably the main trace of the Zayante fault, is visible for a thousand or so feet in either direction; however, south-southwest of the parcel the central portion of the tonal lineament is obscured by a landslide deposit (Figure 6). The landslide deposit extends from the southwest side of the lineament and toes in the broad swale south of the subject parcel.

A subtle topographic and tonal lineament appears in the air photos on the lower portion of the slope in the northeast corner of the subject property. The roughly curved lineament roughly coincides with a distinct break in slope mapped during our site reconnaissance (Plate 1). A moderately steep, arcuate slope extends northward from the northeast property corner and roughly parallel to the incised perennial drainage.

We also identified a very subtle, semi-arcuate lineament in the southeast portion of the parcel during our air photo analysis of the subject site in the 1935 air photos (Figure 6). The location and trend of this lineament is roughly consistent with the areas of significant liquefaction and lateral spread related deformation observed in trenches 2 and 5.

We saw no evidence during our air photo analysis of the subject area to suggest that a trace of the Zayante fault transects the parcel.

GEOLOGIC HAZARDS

Fault Ground Surface Rupture

The subject parcel lies partially within both the county and state fault zones for the Zayante fault. As depicted on Figure 6, the county and state fault zones trend through the northwest corner of the parcel at distances of about 100 and 55 feet, respectively. The Alquist-Priolo Earthquake Fault Zone map of the area shows no potentially active faults within about 400 feet of the site (Figure 5). A *probable* trace of the Zayante fault is mapped by Coppersmith (1979)(Figure 4) paralleling the small, northwest-trending perennial stream immediately northeast of the parcel. A possible fault

trace depicted by Coppersmith (1979) trends toward the middle of the parcel from the south but terminates approximately 200 feet from the property (Figure 4).

The nearest photolineament and likely fault trace we observed during our air photo and LiDAR analysis of the site was approximately 400 feet southwest of the parcel (Figure 6). We saw no evidence of tectonically-related offsets during our surface and subsurface investigation of the site, or during our review of an exploratory trench log completed by the previous geologist for the project.

Seismic Shaking

Seismic shaking at the subject site will be intense during the next major earthquake along local fault systems. Modified Mercalli Intensities of up to IX are possible at the site (see Table 1), based on the intensities reported by Lawson et al. (1908) for the 1906 earthquake and by Stover et al. (1990) for the 1989 Loma Prieta earthquake. It is important that recommendations regarding seismic shaking be used in the design for the proposed development.

TABLE 1
Modified Mercalli Intensity Scale

The modified Mercalli scale measures the intensity of ground shaking as determined from observations of an earthquake's effect on people, structures, and the Earth's surface. Richter magnitude is not reflected. This scale assigns to an earthquake event a Roman numeral from I to XII as follows:

I	Not felt by people, except rarely under especially favorable circumstances.
II	Felt indoors only by persons at rest, especially on upper floors. Some hanging objects may swing.
III	Felt indoors by several. Hanging objects may swing slightly. Vibration like passing of light trucks. Duration estimated. May not be recognized as an earthquake.
IV	Felt indoors by many, outdoors by few. Hanging objects swing. Vibration like passing of heavy trucks; or sensation of a jolt like a heavy ball striking the walls. Standing automobiles rock. Windows, dishes, doors rattle. Wooden walls and frame may creak.
V	Felt indoors and outdoors by nearly everyone; direction estimated. Sleepers wakened. Liquids disturbed, some spilled. Small unstable objects displaced or upset; some dishes and glassware broken. Doors swing; shutters, pictures move. Pendulum clocks stop, start, change rate. Swaying of tall trees and poles sometimes noticed.
VI	Felt by all. Damage slight. Many frightened and run outdoors. Persons walk unsteadily. Windows, dishes, glassware broken. Knickknacks and books fall off shelves; pictures off walls. Furniture moved or overturned. Weak plaster and masonry cracked.
VII	Difficult to stand. Damage negligible in buildings of good design and construction; slight to moderate in well-built ordinary buildings; considerable in badly designed or poorly built buildings. Noticed by drivers of automobiles. Hanging objects quiver. Furniture broken. Weak chimneys broken. Damage to masonry; fall of plaster, loose bricks, stones, tiles, and unbraced parapets. Small slides and caving in along sand or gravel banks. Large bells ring.
VIII	People frightened. Damage slight in specially designed structures; considerable in ordinary substantial buildings, partial collapse; great in poorly built structures. Steering of automobiles affected. Damage or partial collapse to some masonry and stucco. Failure of some chimneys, factory stacks, monuments, towers, elevated tanks. Frame houses moved on foundations if not bolted down; loose panel walls thrown out. Decayed pilings broken off. Branches broken from trees. Changes in flow or temperature of springs and wells. Cracks in wet ground and on steep slopes.
IX	General panic. Damage considerable in specially designed structures; great in substantial buildings, with some collapse. General damage to foundations; frame structures, if not bolted, shifted off foundations and thrown out of plumb. Serious damage to reservoirs. Underground pipes broken. Conspicuous cracks in ground; liquefaction.
X	Most masonry and frame structures destroyed with their foundations. Some well-built wooden structures and bridges destroyed. Serious damage to dams, dikes, embankments. Landslides on river banks and steep slopes considerable. Water splashed onto banks of canals, rivers, lakes. Sand and mud shifted horizontally on beaches and flat land. Rails bent slightly.
XI	Few, if any masonry structures remain standing. Bridges destroyed. Broad fissures in ground; earth slumps and landslides widespread. Underground pipelines completely out of service. Rails bent greatly.
XII	Damage nearly total. Waves seen on ground surfaces. Large rock masses displaced. Lines of sight and level distorted. Objects thrown upward into the air.

Deterministic Seismic Shaking Analysis

For the purpose of evaluating deterministic peak ground accelerations for the site, we have considered the San Andreas fault zone. While other faults or fault zones in this region are active, their potential contribution to seismic shaking at the site is overshadowed by the relatively short recurrence interval of earthquakes on the San Andreas fault. Table 2 shows the moment magnitude of the characteristic or maximum earthquake, its estimated recurrence interval, and the distance from the causative fault to the site. We took the fault data from "The Uniform California Earthquake Rupture Forecast, Version 2" (WGCEP, 2008), "2008 United States National Seismic Hazard Maps" (Petersen et al., 2008) and "Probabilistic Seismic Hazard Assessment for the State of California" (Petersen et al., 1996).

Also shown on Table 2 are deterministically derived accelerations. These accelerations are based on attenuation relationships developed from the analysis of historical earthquakes. It is important to understand that shaking estimates of potential future earthquakes are based on the statistical analysis of shaking generated by past earthquakes. The calculated accelerations listed in Table 2 are the best estimates given the current methods and their application to the current database of past earthquakes. Therefore, we caution that the listed values are approximations, rather than precise predictions. Actual measured "free-field" accelerations at the site may be larger. Because the historical data can be interpreted in different ways, there are a number of different attenuation relationships available.

We have employed a set of up to five attenuation relationship models compiled by the Pacific Earthquake Engineering Research Center (PEER, 2014) in estimating the acceleration values. The resulting accelerations listed are based upon numerous factors, including magnitude, closest distance to the rupture plane, fault type (strike slip, normal, or reverse), as well as site soil classification. In addition, the regressions are adapted for the specific setting of shallow crustal earthquakes in active tectonic regions (e.g., western North America). The attenuation models therefore provide region-specific flexibility within the tectonic setting of California. We have not performed site-specific seismic shaking evaluations. No on-site or laboratory measurements were made to evaluate site-specific seismic response. The values listed, however, do reflect the site soil classification.

If the deterministically derived accelerations are used for engineering analysis on the subject property, we recommend utilizing the accelerations generated by the San Andreas fault. This is due to the high predicted ground accelerations and the short recurrence interval of the San Andreas fault zone. Based on the results listed in Table 2, the earthquake ground motion (mean peak acceleration) expected at the subject property will be approximately 0.56g, based on a M_w 7.9 earthquake centered on the San Andreas fault 4.1 kilometers (2.5 miles) northeast of the site. The duration of strong shaking is dependent on magnitude. Bray & Rathje (1998) have suggested a relationship between magnitude, distance, and duration of strong shaking. On the basis of their relationship, the duration of strong shaking associated with a San Andreas faulting event generating a magnitude 7.9 earthquake and occurring 4.1 km from the site is estimated to be about 30 seconds. This long duration of seismic shaking may be even more critical as a design parameter than the peak acceleration itself.

For pseudostatic slope stability analysis of the subject site, we recommend a site-specific seismic coefficient (k) of 0.33 as calculated utilizing the Bray & Rathje (1998) procedure.

Fault Segment(s)	Moment Magnitude of Characteristic or Maximum Earthquake (M_w)	Estimated Recurrence Interval (years)	Site Soil Classification	Distance from Site (km)	Estimated Mean Peak Ground Acceleration (g)	Estimated Mean + One Dispersion Ground Acceleration (g)
San Andreas (1906 rupture)	7.9	210	(D) Stiff Soil	4.1	0.56	0.94
Zayante-Vergeles	7.1	3,000		0.3	0.63	1.06
Monterey Bay - Tularcitos	7.1	2,800		21.0	0.18	0.31
Calaveras (multi-segment rupture?)	6.8	450		24.1	0.17	0.31

Erosion

The relatively young alluvium underlying the subject parcel is noncemented and as a result is subject to erosion from uncontrolled or misdirected runoff. This is especially true for sloping portions of the site.

Slope Stability

No landslides are depicted by Cooper Clark (1975) in the vicinity of the subject property.

Due to a lack of steep slopes, relatively flat-lying and laterally discontinuous subsurface earth materials on the property, and because we saw no evidence for past landsliding proximal to the site, a slope stability analysis was not performed for the subject slopes.

We did observe, however, offset stratigraphy in our exploratory trenches suggestive of liquefaction-induced settlement and lateral spreading. We will discuss this mode of ground failure in the following section.

Liquefaction and Lateral Spreading Analysis

Liquefaction-induced ground failures occur when shallow, saturated, unconsolidated sands and silts undergo a loss of strength during large regional earthquakes. Differential settlement is a typical mode of ground deformation resulting from liquefaction. If the ground surface is sloping, or there is a free face nearby such as a streambank, a lateral spread may occur. Lateral spreading is the horizontal displacement of an overlying block of soil resulting from liquefaction of an underlying stratum. Lateral spreads can occur on very gentle slopes and result in vertical deformation of the ground surface such as settlement and heaving, and horizontal extension and translation of the ground. Inadequately founded structures constructed upon liquefiable ground may experience considerable damage as a result of lateral spreading caused by a large, liquefaction-inducing earthquake.

No liquefaction or lateral spreads resulting from the 1989 Loma Prieta Earthquake (Pike et al., 1994) and no ground failures associated with the 1906 San Francisco Earthquake (Youd and Hoose, 1978) were mapped in the vicinity of the subject property. Dupre (1975) describes the Terrace Deposits of Watsonville which underlie the subject parcel as having low potential for liquefaction.

Subsurface data collected in the six CPT borings advanced by the project geotechnical engineer indicates the presence of liquefiable material and high groundwater beneath the site. Subsequent liquefaction analysis performed by the geotechnical engineer calculated liquefaction-induced vertical settlements of up to 1.5 inches for the site. Please refer to the report by the project geotechnical engineer for details regarding their analyses (Rock Solid Engineering, 2016).

The project geotechnical engineer also performed a lateral spreading analysis for the site. However, because the site slopes are greater than the allowable range of inputs for the analysis, the results yielded unrealistic or inaccurate magnitudes of deformation. The lateral spreading analysis performed, utilizing existing slope and subsurface data for the site, resulted in lateral spread displacements of 30 inches or more at the site, greater than any *cumulative* lateral spread displacements observed in our exploratory trenches.

During our field reconnaissance and subsurface investigation, we saw surface evidence suggesting relatively recent lateral spreading on the subject site. In our exploratory trenches we measured individual horizontal offsets and cumulative extensional offsets resulting from liquefaction-induced lateral spreading. The largest horizontal displacement measured by our firm across an individual offset was six inches. The largest distributed extension through a given length of trench was 1.25 feet over 13 feet, or about 1.0 inch per lineal foot. These horizontal displacements should be considered maximum values as the site has experienced repeated liquefaction events, with renewed extension and horizontal ground displacement across existing shears and liquefied zones during each liquefaction event. We also measured vertical offsets or thickening of the surface soil of up to six inches in our exploratory trenches.

CONCLUSIONS

The subject property, located on Trembley Lane in Watsonville, California, lies partially within the County and State fault zones designated for the Zayante fault. A nine parcel residential subdivision is proposed on the flat to gently sloping parcel. Relevant geologic concerns for the property include seismic shaking, liquefaction and lateral spreading, and erosion.

The site is underlain by relatively flat-lying, Pleistocene aged fluvial deposits consisting of interbedded clays, silts, sands and gravels. Shallow groundwater exists beneath the lower slopes of the property.

We excavated and logged five exploratory trenches in the eastern half of the parcel. The trenches revealed evidence of liquefaction and lateral spreading. The coarser grained earth materials comprising the uppermost portions of the trenches are indicative of a higher energy depositional environment at the site: one that obviously does not exist today. Some of the coarser deposits infill small extensional grabens within the finer grained materials they overlie, suggesting that liquefaction and lateral spreading has episodically occurred at the site for tens of thousands of

years. Offset surface soils and a topographic step in the ground surface on the property indicate that liquefaction and lateral spreading has occurred in the recent geologic past. The amount of liquefaction and lateral spread related deformation observed in the trenches generally decreased upslope, likely due to thicker overburden above liquefiable zones.

Individual horizontal offsets of up to six inches, and cumulative extensional displacement of up to 1.0 inch per lineal foot was measured in our exploratory trenches. These should be considered maximum values as the site has experienced multiple liquefaction events, with recurring offset along preexisting shears. We measured up to six inches of vertical offset or thickening of the surface soils in our exploratory trenches at the site.

Potentially liquefiable material was encountered in the six CPT borings advanced by the project geotechnical engineer. Subsequent liquefaction analysis by the project geotechnical engineer, based on in-situ conditions, indicates a potential for liquefaction-induced vertical settlements of up to 1.5 inches. Based on our subsurface investigation of the site, and the presence of liquefiable soils at depth, it is our opinion that the risk of liquefaction and lateral spreading within the proposed development area is moderate.

No suspected faults transecting the parcel were identified during our surface and subsurface investigation, air photo and LiDAR analysis, or literature review of the site. The main trace of the Zayante fault is presumed to trend approximately 400 feet southwest of the property within a broad drainage area. Based on our findings, the potential for fault ground-surface rupture within the geologically feasible building envelope depicted on Plate 1 is low.

Seismic shaking at the subject site will be intense during the next major earthquake along local fault systems. Modified Mercalli Intensities of up to IX are possible at the site. The mean peak acceleration expected at the subject property will be approximately 0.56g, based on a M_w 7.9 earthquake centered on the San Andreas fault 4.1 kilometers (2.5 miles) northeast of the site. The duration of strong shaking at the site during this seismic event is estimated to be about 30 seconds. We calculated a site-specific seismic coefficient (k) of 0.33 for the site.

Due to a lack of steep slopes, relatively flat-lying and laterally discontinuous subsurface earth materials on the property, and because we saw no evidence for past landsliding proximal to the site, a slope stability analysis was not performed for the subject slopes.

The earth materials underlying the subject parcel are subject to erosion from uncontrolled runoff. The potential for erosion resulting from uncontrolled runoff at the subject site can be reduced to an acceptable level with carefully designed and implemented drainage plans.

The proposed development on the subject property will be subject to "ordinary" risks (as defined in Appendix B) over its assumed design lifetime of 100 years if our recommendations and those of the project geotechnical engineer are followed. Appendix B should be reviewed in detail by the property owner to determine whether an "ordinary" level of risk is acceptable. If "ordinary" risks as defined are unacceptable, then the geologic hazards in question should be further mitigated to reduce the corresponding risks to a lower level.

RECOMMENDATIONS

1. The development proposed for the subject property is geologically feasible and should be situated within the building envelope depicted on Plate 1. The envelope is consistent with the current agricultural and side yard zoning setbacks shown on Plate 1, with the exception that it provides a 20 to 25 foot setback from the top of the topographic step and infilled graben in the northeastern property corner. A representative from our firm must verify that all residential development on the parcel is sited within the building envelope. Modification of the geologically feasible building envelope, if possible, to decrease the setback from the graben in the northeast corner of the parcel will require additional subsurface investigation and analysis by our firm.
2. The proposed dwellings should be supported by foundations which adequately accommodate the effects of liquefaction-induced settlement, liquefaction-induced lateral spreading, and expansive or compressive soils. Vertical settlements of up to six inches, and distributed horizontal downslope extension of up to one inch per foot (5 feet of extension beneath the foundation of a 60 foot long house) are possible at the site for lots 2 thru 6. Lesser downslope extension of up to one-half inch per foot (2.5 feet of extension beneath the foundation of a 60 foot long house) is possible for lots 1, 7, 8, and 9. Foundation types which may accommodate differential settlement and extension include reinforced structural slab and reinforced grid foundations. Engineered fill reinforced with geogrid fabric, used in conjunction with the above foundation types may provide additional mitigation against differential settlement and extension. Please refer to the recommendations within the geotechnical engineering report for suitable foundation design criteria.
3. The project engineers and architect should review our seismic shaking parameters and choose a value appropriate for their particular analyses.
4. Drainage from improved surfaces, such as walkways, patios, roofs and driveways on the property should be collected in impermeable gutters or pipes and either carried to the base of the slope via closed conduit or discharged into an established storm drain system that does not issue onto the slope. At no time should any concentrated discharge be allowed to spill directly onto the ground adjacent to the residence. The control of runoff is essential for control of erosion and prevention of ponding.
5. We request the privilege of reviewing all geotechnical, civil and structural engineering; and drainage, septic and architectural reports and plans pertaining to the proposed development and mitigation measures.

INVESTIGATION LIMITATIONS

1. The conclusions and recommendations contained herein are based on probability and in no way imply that the proposed development will not possibly be subjected to ground failure, seismic shaking, or landsliding of such a magnitude that it overwhelms the site. The report does suggest that using the site for residential purposes in compliance with the recommendations contained herein is an acceptable risk.

2. This report is issued with the understanding that it is the duty and responsibility of the owner or his representative or agent to ensure that the recommendations contained in this report are brought to the attention of the architect and engineers for the project, incorporated into the plans and specifications, and that the necessary steps are taken to see that the contractor and subcontractors carry out such recommendations in the field.
3. If any unexpected variations in soil conditions or if any undesirable conditions are encountered during construction, Easton Geology, Inc. should be notified so that supplemental recommendations may be given.

REFERENCES

Aerial Photographs

- January 1935 (1935), frames 3300-74, 75, and 76, black and white, nominal scale 1:19,512, U.S. Soil Erosion Service.
- 22 October 1939 (1939-A), frames CJA-297-103, and 104, black and white, nominal scale 1:20,000, U.S. Department of Agriculture.
- 14 May 1948 (1948), frames CDF5-3-100 and 101, black and white, nominal scale 1:10,000, U.S. Forest Service.
- 2 June 1956 (1956-B), frames CJA-2R-25, and 26, black and white, nominal scale 1:10,000, U.S. Department of Agriculture.
- 24 June 1963 (1963-E), frames CJA-1DD-210 and 211, black and white, nominal scale 1:10,000, U.S. Department of Agriculture.
- 14 October 1975 (1975), frames SCZCO 1-219, 220, and 221, black and white, nominal scale 1:12,000, Santa Cruz County Resources Agency, Planning Department.
- 26 October 1989 (1989-F), frames WATSONVILLE WEST 14-8, and 9, black and white nominal scale 1:24,000, U.S. Geological Survey.
- 22 June 1994 (1994), frames 5-7, and 8, black and white, nominal scale 1:15,840, Big Creek Lumber.

Photos are available for viewing at the Map Room in the University Library at the University of California, Santa Cruz, with their collections referenced above in parentheses (e.g., 1990-B, etc.)

Maps and Reports

- Aagaard, B.T., Blair, J.L., Boatwright, J., Garcia, S.H., Harris, R.A., Michael, A.J., Schwartz, D.P., and DiLeo, J.S., 2016, Earthquake outlook for the San Francisco Bay region 2014-2043: U.S.G.S. Fact Sheet 2016-3020, 6p., <http://dx.doi.org/10.3133/fs20163020>.
- Bray, J.D. and Rathje, E.M., 1998, Earthquake-induced displacements of solid-waste landfills, *Journal of Geotechnical and Geoenvironmental Engineering*, v. 124, no. 3, p. 242-253.
- Bryant, W.A., and Cluett, S.E., compilers, 1999, Calaveras fault zone, Northern, Central, and Southern Calaveras sections, in Quaternary fault and fold database of the United States: U.S. Geological Survey website, <http://earthquakes.usgs.gov/hazards/qfaults>, accessed 11/30/16.

- Bryant, W.A., compiler, 2001, Monterey Bay–Tularcitos fault zone, *in* Quaternary fault and fold database of the United States: U.S. Geological Survey website, <http://earthquakes.usgs.gov/hazards/qfaults>, accessed 11/30/16.
- Bryant, W.A., compiler, 2000, Zayante-Vergeles fault zone, *in* Quaternary fault and fold database of the United States: U.S. Geological Survey website, <http://earthquakes.usgs.gov/hazards/qfaults>, accessed 11/30/16.
- Bryant, W.A., and Lundberg, M., compilers, 2002, San Andreas fault zone, Peninsula section, *in* Quaternary fault and fold database of the United States: U.S. Geological Survey website, <http://earthquakes.usgs.gov/hazards/qfaults>, accessed 07/20/16.
- Buchanan-Banks, J.M., Pampeyan, E.H., Wagner, H.C., and McCulloch, D.S., 1978, Preliminary map showing recency of faulting in coastal south-central California, U. S. Geological Survey Miscellaneous Field Studies Map MF-910, 3 sheets, scale 1:250,000.
- Burkland and Associates, 1975, Geotechnical study for the seismic safety element, prepared for the Planning Department, Monterey County, California, 125 p.
- California Division of Mines and Geology, 2000, Official Map of Alquist-Priolo Earthquake Fault Zones, Watsonville East Quadrangle, 1982, DMG CD 2000-04.
- California Division of Mines and Geology, 2000, Official Map of Alquist-Priolo Earthquake Fault Zones, Watsonville West Quadrangle, 1976, DMG CD 2000-04.
- California Geological Survey, 2006, Simplified Geologic Map of California, Map Sheet 57, approximate scale 1:2,250,000.
- Clark, J.C., and Reitman, J.D., 1973, Oligocene stratigraphy, tectonics, and paleogeography southwest of the San Andreas fault, Santa Cruz Mountains and Gabilan Range, California Coast Ranges, U. S. Geological Survey Professional Paper 783, 18 p.
- Coppersmith, K.J., 1979, Activity Assessment of the Zayante-Vergeles Fault, Central San Andreas Fault System, California, Unpublished Ph.D. dissertation, University of California, Santa Cruz, 216 p.
- Dupré, W.R., 1975, Geology and Liquefaction Potential of Quaternary Deposits in Santa Cruz County, California, U.S. Geological Survey Miscellaneous Field Studies Map MF-648, 2 sheets, scale 1:62,500.
- Field, E.H., and 2014 Working Group on California Earthquake Probabilities, 2015, UCERF3: A new earthquake forecast for California's complex fault system: U.S. Geological Survey 2015–3009, 6 p., <https://dx.doi.org/10.3133/fs20153009>.
- Greene, H.G., 1977, Geology of the Monterey Bay region, California, U. S. Geological Survey Open-File Report 77-718, 347 p., 9 plates, scale 1:200,000.

- Griggs, G.B., 1973, Earthquake activity between Monterey and Half Moon Bays, California, *California Geology*, v. 26, p. 103-110.
- Hall, N.T., Sarna-Wojcicki, A.M., and Dupré, W.R., 1974, Faults and their potential hazards in Santa Cruz County, California, U. S. Geological Survey Miscellaneous Field Studies Map MF-626, 3 sheets, scale 1:62,500.
- Harwood, C.S., 2014, Engineering geologic evaluation, proposed residential subdivision, APN 051-411-20, off Trembley Lane, Watsonville, California, Job No. G-349.1, Unpublished Consultants Report prepared August 5, 2014, 17p.
- Jennings, C.W., Strand, R.G., and Rogers, T.H., 1975, Fault map of California, California Division of Mines and Geology, California Geologic Data Map Series, map no. 1.
- Lawson, A.C., Gilbert, G.K., Reid, H.F., Branner, J.C., Fairbanks, H.W., Wood, H.O., Hayford, J.F., Baldwin, A.L., Omori, F., Leuschner, A.O., Davidson, G., Matthes, F.E., Anderson, R., Louderback, G.D., Holway, R.S., Eakle, A.S., Crandall, R., Hoffman, G.F., Warring, G.A., Hughes, E., Rogers, F.J., and Baird, A., 1908, The California Earthquake of April 18, 1906, Report of the State Earthquake Investigation Commission, Carnegie Institution of Washington, Publication 87, 2 v. and atlas, 600 p.
- Pacific Earthquake Engineering Research Center, 2014, Weighted Average of 2014 NGA WEST-2 GMPEs, last updated 22 February 2014, available at: <http://peer.berkeley.edu/ngawest2/databases/>
- Petersen, M.D., Bryant, W.A., Cramer, C.H., Cao, T., Reichle, M.S., Frankel, A.D., Lienkamper, J.J., McCrory, P.A., Schwartz, D.P., 1996, Probabilistic seismic hazard assessment for the State of California: California Division of Mines and Geology Open-File Report issued jointly with United States Geological Survey, CDMG 96-08 and USGS 96-706, 52p.
- Petersen, Mark D., Frankel, Arthur D., Harmsen, Stephen C., Mueller, Charles S., Haller, Kathleen M., Wheeler, Russell L., Wesson, Robert L., Zeng, Yuehua, Boyd, Oliver S., Perkins, David M., Luco, Nicolas, Field, Edward H., Wills, Chris J., and Rukstales, Kenneth S., 2008, Documentation for the 2008 Update of the United States National Seismic Hazard Maps: U.S. Geological Survey Open-File Report 2008-1128, 61 p. http://geohazards.usgs.gov/cfusion/hazfaults_search/hf_search_main.cfm
- Pike, R.J., Bernknopf, R.L., Tinsley, J.C., III, and Mark, R.K., 1994, Hazard of Earthquake-Induced Lateral-Spread Ground Failure on the Central California Coast Modeled from Earth-Science Map Data in a Geographic Information System, U.S. Geological Survey Open File Report 94-0662, 46p., 1 plate, scale 1: 62,500.
- Rock Solid Engineering, 2016, Geotechnical Investigation – Design Phase, Proposed Subdivision, Trembley Lane, Watsonville, California, Project No. 14034, prepared December 9, 2016, 71p.

- Roper Engineering, 2014, Agricultural Exhibit, Lakeview Estates, Trembley Lane, Watsonville, APN 051-411-20, Job No. 14036, sheet AG1 dated October 15, 2014.
- Roper Engineering, 2014, Tentative Map, Tract No. 1582, Lakeview Estates, Trembley Lane, Watsonville, APN 051-411-20, Job No. 14036, sheet T1 dated September 18, revised December 30, 2014.
- Ross, D.C., and Brabb, E.E., 1973, Petrography and structural relations of granitic basement rocks in the Monterey Bay area, California, U. S. Geological Survey Journal of Research, v. 1, p. 273-282.
- Santa Cruz County Geographic Information System,
<http://gis.co.santa-cruz.ca.us/PublicGISWeb/>, accessed 8 December 2016.
- Schwartz, S.Y., Orange, D.L., and Anderson, R.S., 1990, Complex fault interactions in a restraining bend on the San Andreas fault, southern Santa Cruz Mountains, California, Geophysical Research Letters, v. 17, p. 1207-1210.
- Stover, C.W., Reagor, B.G., Baldwin, F.W., and Brewer, L.R., 1990, Preliminary isoseismal map for the Santa Cruz (Loma Prieta), California, earthquake of October 18, 1989 UTC, U. S. Geological Survey Open-File Report 90-18, 24 p.
- Sykes, L.R., and Nishenko, S.P., 1984, Probabilities of occurrence of large plate-rupturing earthquakes for the San Andreas, San Jacinto, and Imperial faults, California, 1983-2003, Journal of Geophysical Research, v. 89, p. 5905-5927.
- U.S. Geological Survey, 1998, Preliminary Map of Landslide Deposits in Santa Cruz County, California – A Digital Map Database, landslides mapped by Cooper-Clark & Associates, 1975, digital compilation by Sebastian Roberts & Andrew D. Baron, 1998, OFR 98-792, scale 1:62,500.
- U.S. Geological Survey, 2012, Watsonville East Quadrangle, California-Santa Cruz Co., 7.5-minute series, scale 1:24,000.
- U.S. Geological Survey, 2012, Watsonville West Quadrangle, California-Santa Cruz Co., 7.5-minute series, scale 1:24,000.
- Wallace, R.E., editor, 1990, The San Andreas fault system, California, U. S. Geological Survey Professional Paper 1515, 283 p.
- Working Group on California Earthquake Probabilities, 1988, Probabilities of Large Earthquakes Occurring in California on the San Andreas Fault, U. S. Geological Survey Open-File Report 88-398, 62 p.
- Working Group on California Earthquake Probabilities, 1990, Probabilities of large earthquakes in the San Francisco Bay region, California, U. S. Geological Survey Circular 1053, 51 p.
- 2007 Working Group on California Earthquake Probabilities, 2008, The Uniform California

Earthquake Rupture Forecast, Version 2 (UCERF 2): U.S. Geological Survey Open-File Report 2007-1437 and California Geological Survey Special Report 203, April 14, 2008, revised 11 July 2008 (version 1.1), <http://pubs.usgs.gov/of/2007/1437/>

Working Group on Northern California Earthquake Potential, 1996, Database of Potential Sources for Earthquakes Larger than Magnitude 6 in Northern California, U. S. Geological Survey Open-File Report 96-705, 53 p.

Youd, T.L., and Hoose, S.N., 1978, Historic Ground Failures in Northern California Triggered by Earthquakes, U.S. Geological Survey Professional Paper 993, 177p., 5 plates.

APPENDIX A

FIGURES 1 through 6

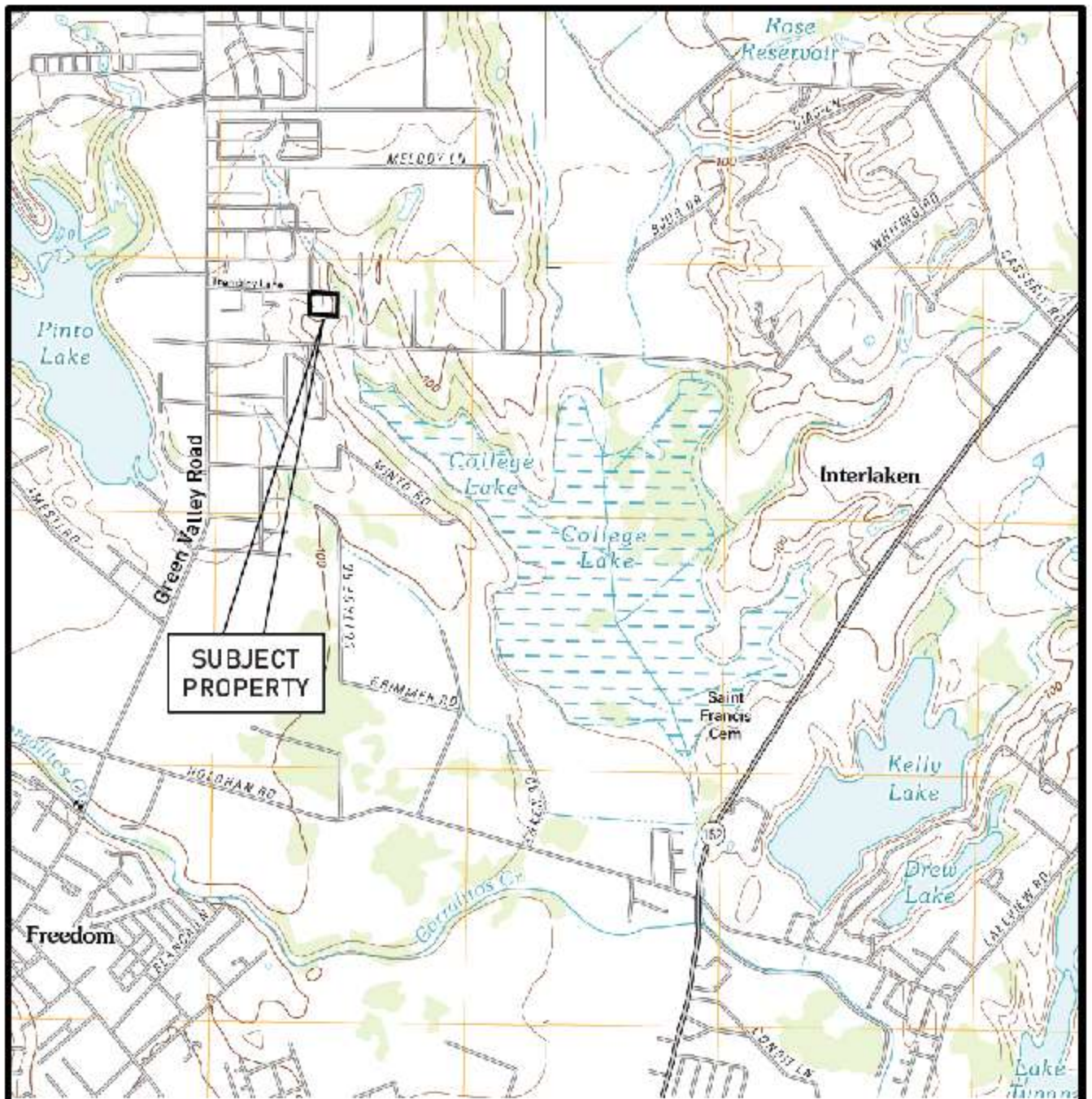

Base Map: U.S. Geological Survey, 2012, Watsonville East and Watsonville West Quadrangles, California-Santa Cruz Co., 7.5-Minute Series.

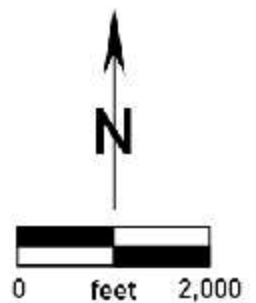

EASTON GEOLOGY, INC.
 P.O. Box 3533
 Santa Cruz, California 95063
 831.247.4317

SITE LOCATION MAP
 Farhat Property
 Trembley Lane
 Watsonville, California
 Santa Cruz County APN 051-411-20

FIGURE #
1
 JOB #
 G15021

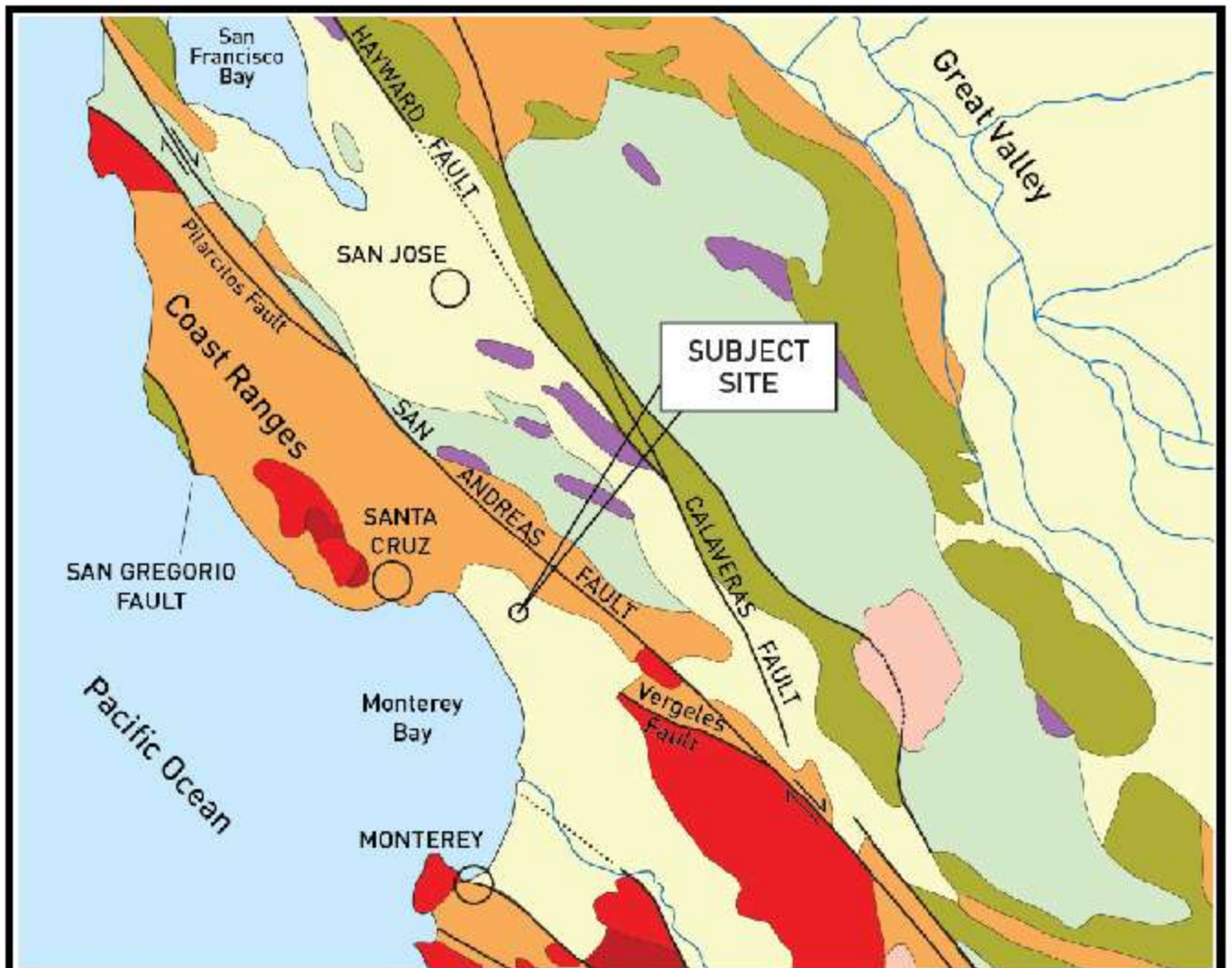

EXPLANATION

This map is based on the Simplified Geologic Map of California, Map Sheet 57

SEDIMENTARY AND VOLCANIC ROCKS

- Cenozoic nonmarine (continental) sedimentary rocks and alluvial deposits
- Cenozoic marine sedimentary rocks
- Cenozoic volcanic rocks

INTRUSIVE AND IGNEOUS METAMORPHIC ROCKS

- Granitic rocks - chiefly Mesozoic
- Serpentinized ultramafic rocks - chiefly Mesozoic
- Pre-Cenozoic metamorphic rocks of unknown age
- Late Mesozoic (latest Jurassic and Cretaceous) marine sedimentary rocks; Great Valley Sequence and related rocks
- Late Mesozoic (latest Jurassic and Cretaceous) rocks of the Franciscan Complex

kilometers

0 10 20 30 40 50



miles

0 10 20 30



SYMBOLS

- Contact
- Fault - dotted where concealed; arrows indicate relative movement on strike-slip faults

EASTON GEOLOGY, INC.
 P.O. Box 3533
 Santa Cruz, California 95063
 831.247.4317

REGIONAL GEOLOGIC MAP
 Farhat Property
 Trembley Lane
 Watsonville, California
 Santa Cruz County APN 051-411-20

FIGURE #
2
 JOB #
 G15021

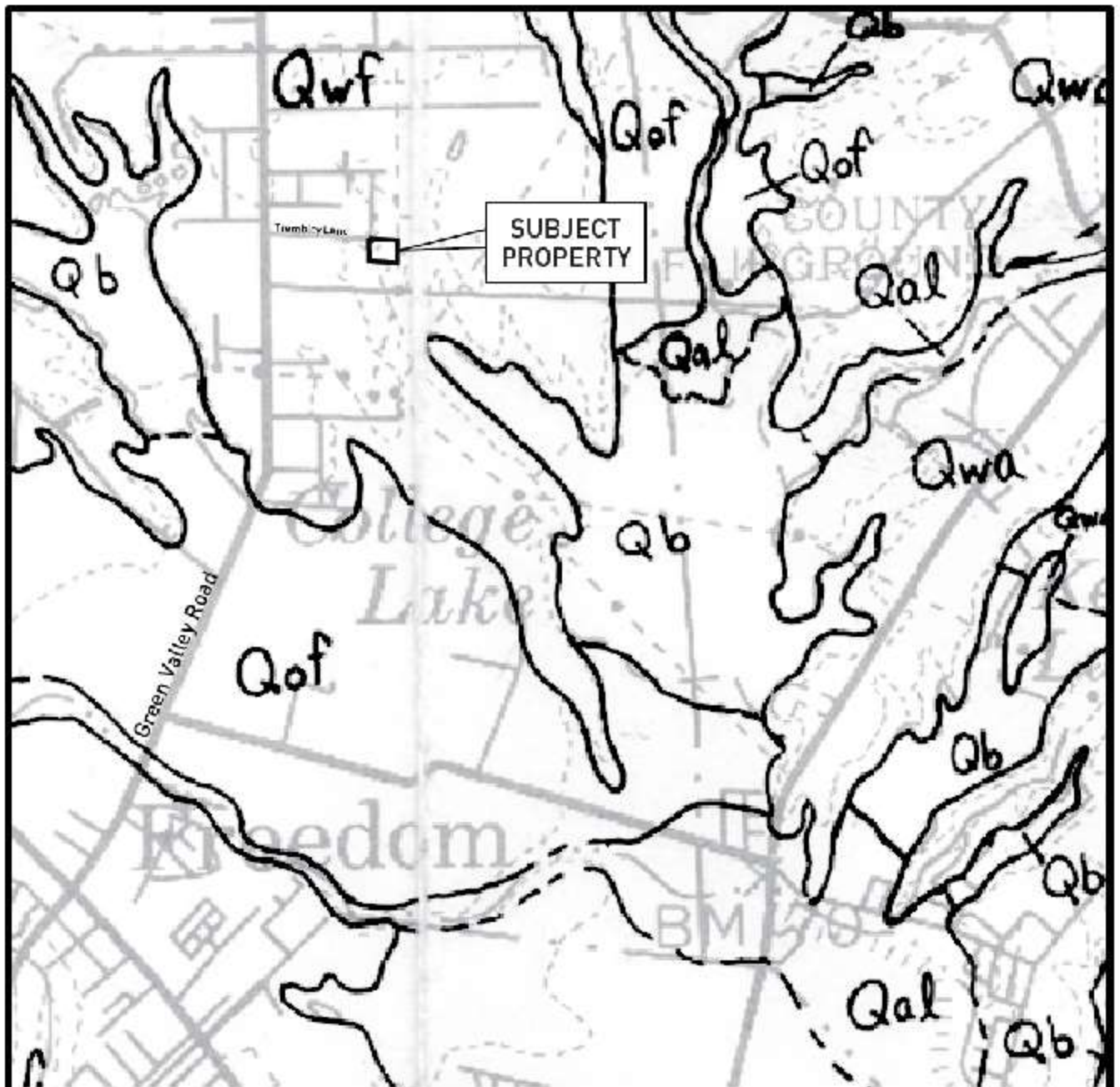

EXPLANATION

- Qb Basin Deposits
- Qal Alluvial Deposits
- Qof Older Floodplain Deposits
- Qwf Terrace Deposits of Watsonville - fluvial facies
- Qwa Terrace Deposits of Watsonville - alluvial fan facies

--- Contact - dashed where approximately located

Base Map: U.S. Geological Survey, 1975, MF-648.

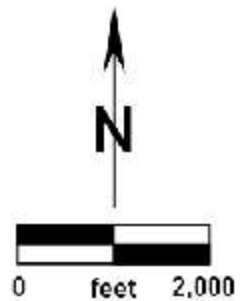



EASTON GEOLOGY, INC.
 P.O. Box 3533
 Santa Cruz, California 95063
 831.247.4317

LOCAL GEOLOGIC MAP
 Farhat Property
 Trembley Lane
 Watsonville, California
 Santa Cruz County APN 051-411-20

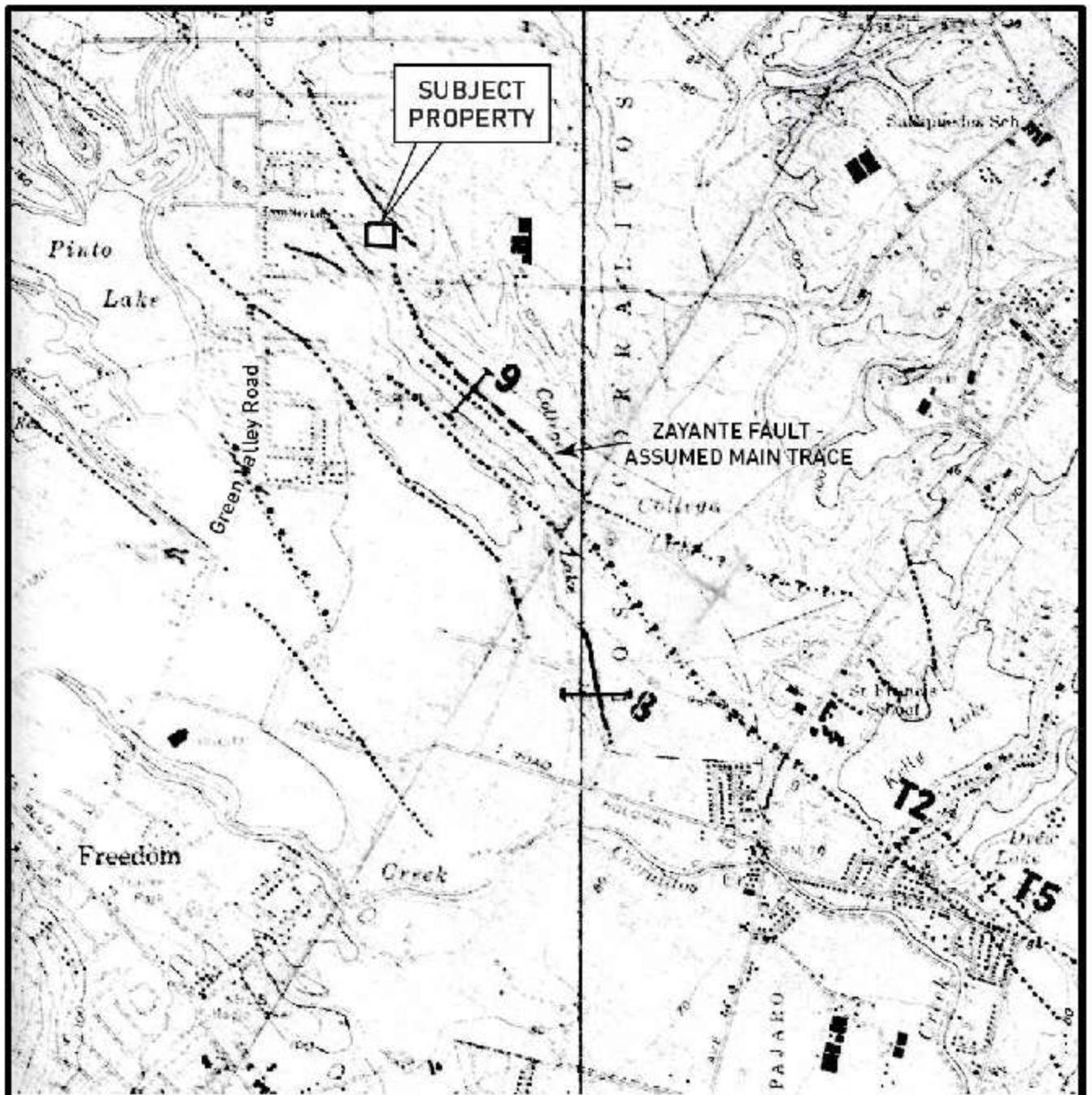
FIGURE #
3
 JOB #
 G15021

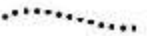
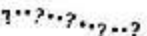

EXPLANATION

-  Probable Fault Trace
-  Possible Fault Trace
-  Linear Feature - photolineament
-  Magnetometer Traverse location
- T5** Trench location

Base Map: Coppersmith, 1979.

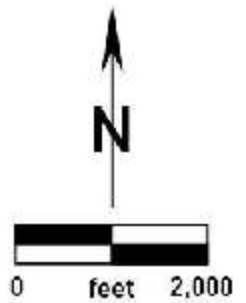

EASTON GEOLOGY, INC.
 P.O. Box 3533
 Santa Cruz, California 95063
 831.247.4317

LOCAL FAULT MAP
 Farhat Property
 Trembley Lane
 Watsonville, California
 Santa Cruz County APN 051-411-20

FIGURE #
4
 JOB #
 G15021

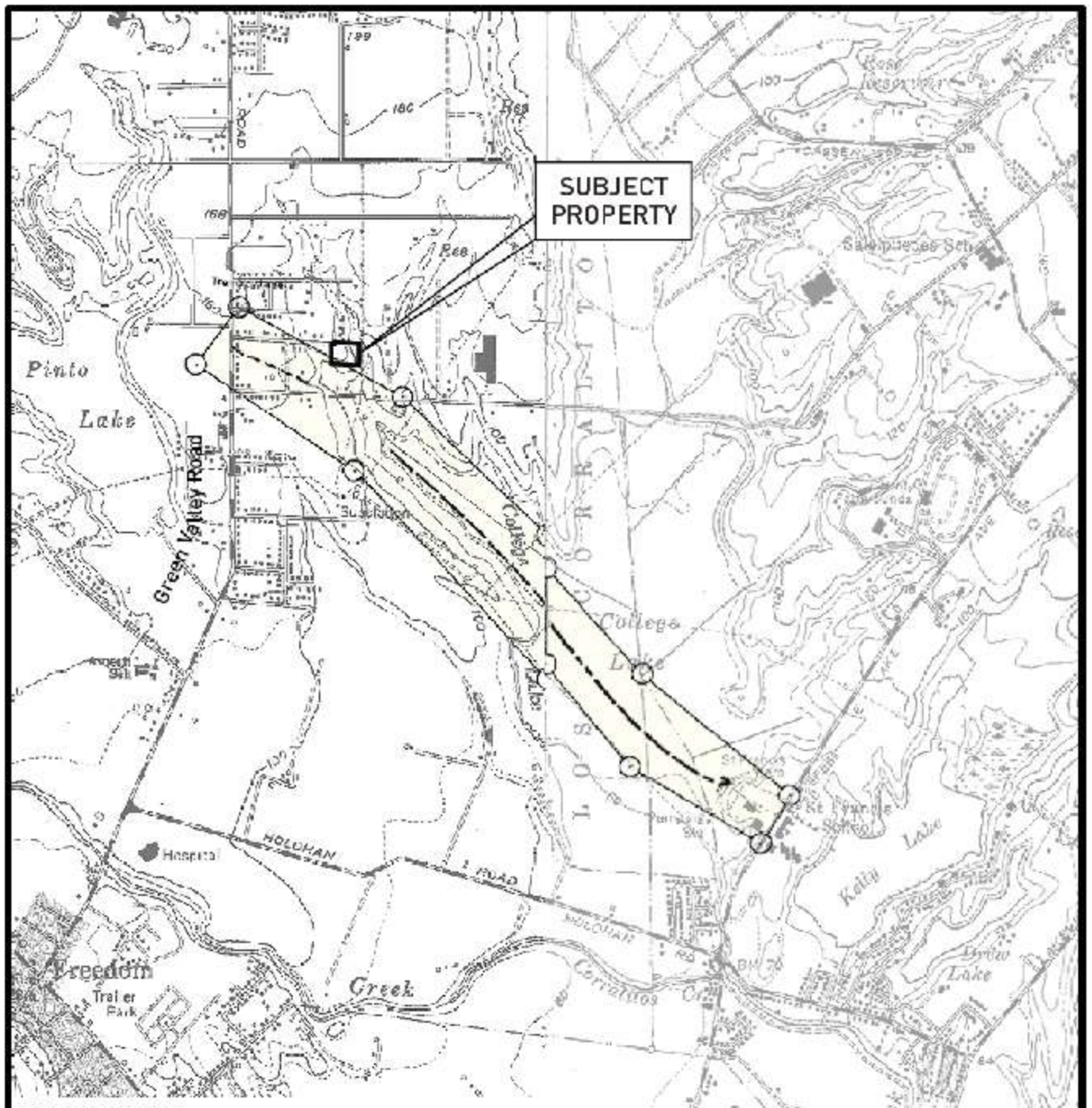

EXPLANATION

-  AP Fault Zone Boundaries
-  Potentially Active Fault - approximate location
-  Potentially Active Fault - inferred location, queried where uncertain

Base Map: CDMG, 2000, Alquist-Priolo Earthquake Fault Zone Maps, Watsonville East (1982) and Watsonville West (1976) Quadrangles.

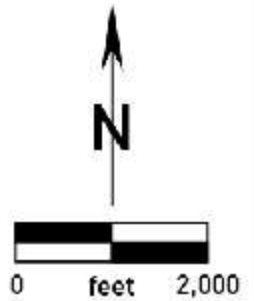

EASTON GEOLOGY, INC.
 P.O. Box 3533
 Santa Cruz, California 95063
 831.247.4317

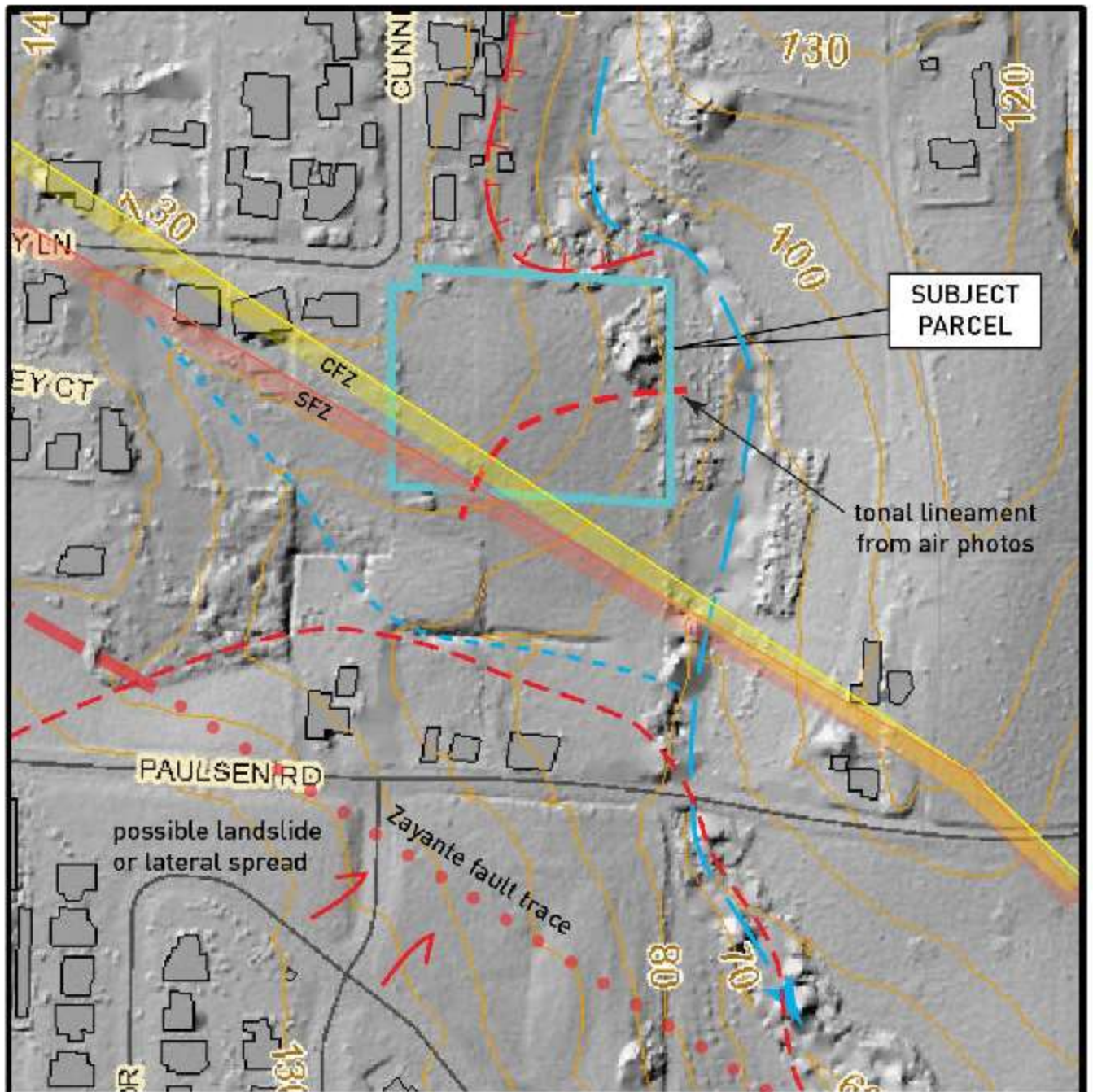

ALQUIST-PRIOLO EARTHQUAKE FAULT ZONE MAP
 Farhat Property
 Trembley Lane
 Watsonville, California
 Santa Cruz County APN 051-411-20

FIGURE #
5
 JOB #
 G15021



EXPLANATION

-  suspected main trace of Zayante fault, dotted where concealed
-  stream channel
-  landslide headscarp and deposit

-  CFZ
County fault zone - northeast boundary
-  SFZ
State fault zone - northeast boundary

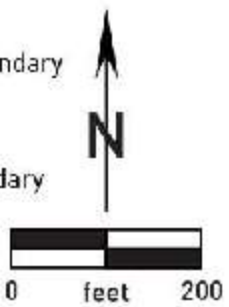

Base Map: Santa Cruz County GIS, 2016.

EASTON GEOLOGY, INC.
 P.O. Box 3533
 Santa Cruz, California 95063
 831.247.4317

LIDAR and AIR PHOTO INTERPRETATION MAP
 Farhat Property
 Trembley Lane
 Watsonville, California
 Santa Cruz County APN 051-411-20

FIGURE #
6
 JOB #
 G15021

APPENDIX B

SCALE OF ACCEPTABLE RISKS FROM GEOLOGIC HAZARDS

SCALE OF ACCEPTABLE RISKS FROM SEISMIC GEOLOGIC HAZARDS		
Risk Level	Structure Types	Extra Project Cost Probably Required to Reduce Risk to an Acceptable Level
Extremely low ¹	Structures whose continued functioning is critical, or whose failure might be catastrophic: nuclear reactors, large dams, power intake systems, plants manufacturing or storing explosives or toxic materials.	No set percentage (whatever is required for maximum attainable safety).
Slightly higher than under "Extremely low" level. ¹	Structures whose use is critically needed after a disaster: important utility centers; hospitals; fire, police and emergency communication facilities; fire station; and critical transportation elements such as bridges and overpasses; also dams.	5 to 25 percent of project cost. ²
Lowest possible risk to occupants of the structure. ³	Structures of high occupancy, or whose use after a disaster would be particularly convenient: schools, churches, theaters, large hotels, and other high rise buildings housing large numbers of people, other places normally attracting large concentrations of people, civic buildings such as fire stations, secondary utility structures, extremely large commercial enterprises, most roads, alternative or non-critical bridges and overpasses.	5 to 15 percent of project cost. ⁴
An "ordinary" level of risk to occupants of the structure. ^{3,5}	The vast majority of structures: most commercial and industrial buildings, small hotels and apartment buildings, and single family residences.	1 to 2 percent of project cost, in most cases (2 to 10 percent of project cost in a minority of cases). ⁴
<p>¹ Failure of a single structure may affect substantial populations.</p> <p>² These additional percentages are based on the assumptions that the base cost is the total cost of the building or other facility when ready for occupancy. In addition, it is assumed that the structure would have been designed and built in accordance with current California practice. Moreover, the estimated additional cost presumes that structures in this acceptable risk category are to embody sufficient safety to remain functional following an earthquake.</p> <p>³ Failure of a single structure would affect primarily only the occupants.</p> <p>⁴ These additional percentages are based on the assumption that the base cost is the total cost of the building or facility when ready for occupancy. In addition, it is assumed that the structures would have been designed and built in accordance with current California practice. Moreover the estimated additional cost presumes that structures in this acceptable-risk category are to be sufficiently safe to give reasonable assurance of preventing injury or loss of life during and following an earthquake, but otherwise not necessarily to remain functional.</p> <p>⁵ "Ordinary risk": Resist minor earthquakes without damage; resist moderate earthquakes without structural damage, but with some non-structural damage; resist major earthquakes of the intensity or severity of the strongest experienced in California, without collapse, but with some structural damage as well as non-structural damage. In most structures it is expected that structural damage, even in a major earthquake, could be limited to repairable damage. (Structural Engineers Association of California)</p> <p>Source: <i>Meeting the Earthquake</i>, Joint Committee on Seismic Safety of the California Legislature, Jan. 1974, p.9.</p>		

SCALE OF ACCEPTABLE RISKS FROM NON-SEISMIC GEOLOGIC HAZARDS⁶		
Risk Level	Structure Type	Risk Characteristics
Extremely low risk	Structures whose continued functioning is critical, or whose failure might be catastrophic: nuclear reactors, large dams, power intake systems, plants manufacturing or storing explosives or toxic materials.	1. Failure affects substantial populations, risk nearly equals nearly zero.
Very low risk	Structures whose use is critically needed after a disaster: important utility centers; hospitals; fire, police and emergency communication facilities; fire station; and critical transportation elements such as bridges and overpasses; also dams.	1. Failure affects substantial populations. Risk slightly higher than 1 above.
Low risk	Structures of high occupancy, or whose use after a disaster would be particularly convenient: schools, churches, theaters, large hotels, and other high rise buildings housing large numbers of people, other places normally attracting large concentrations of people, civic buildings such as fire stations, secondary utility structures, extremely large commercial enterprises, most roads, alternative or non-critical bridges and overpasses.	1. Failure of a single structure would affect primarily only the occupants.
"Ordinary" risk	The vast majority of structures: most commercial and industrial buildings, small hotels and apartment buildings, and single family residences.	<ol style="list-style-type: none"> 1. Failure only affects owners /occupants of a structure rather than a substantial population. 2. No significant potential for loss of life or serious physical injury. 3. Risk level is similar or comparable to other ordinary risks (including seismic risks) to citizens of coastal California. 4. No collapse of structures; structural damage limited to repairable damage in most cases. This degree of damage is unlikely as a result of storms with a repeat time of 50 years or less.
Moderate risk	Fences, driveways, non-habitable structures, detached retaining walls, sanitary landfills, recreation areas and open space.	<ol style="list-style-type: none"> 1. Structure is not occupied or occupied infrequently. 2. Low probability of physical injury. 3. Moderate probability of collapse.

⁶ Non-seismic geologic hazards include flooding, landslides, erosion, wave runup and sinkhole collapse

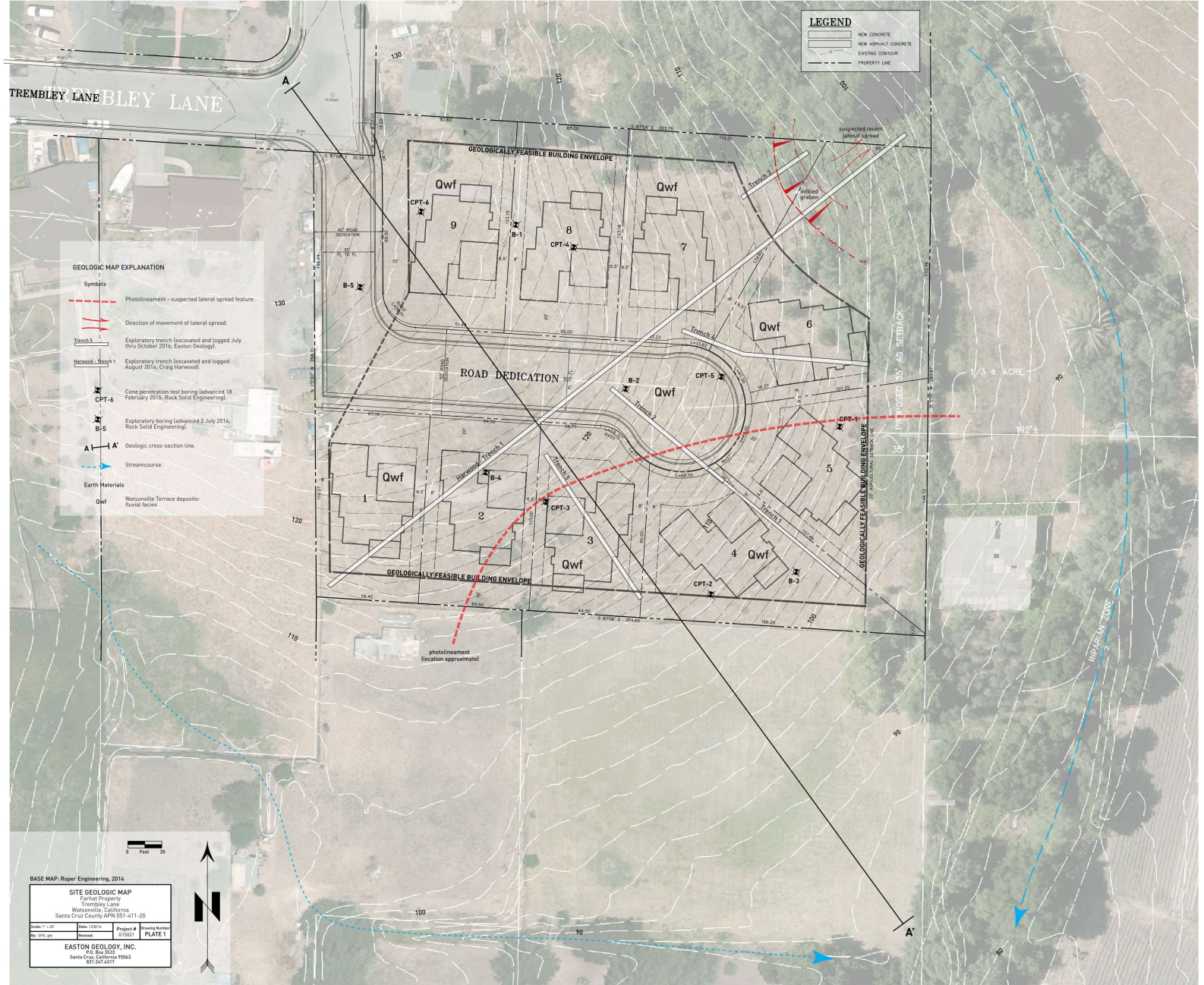

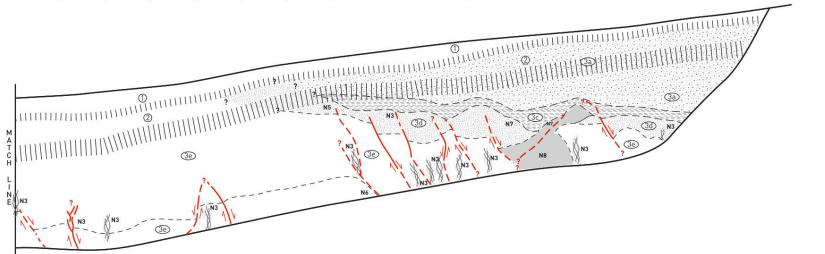
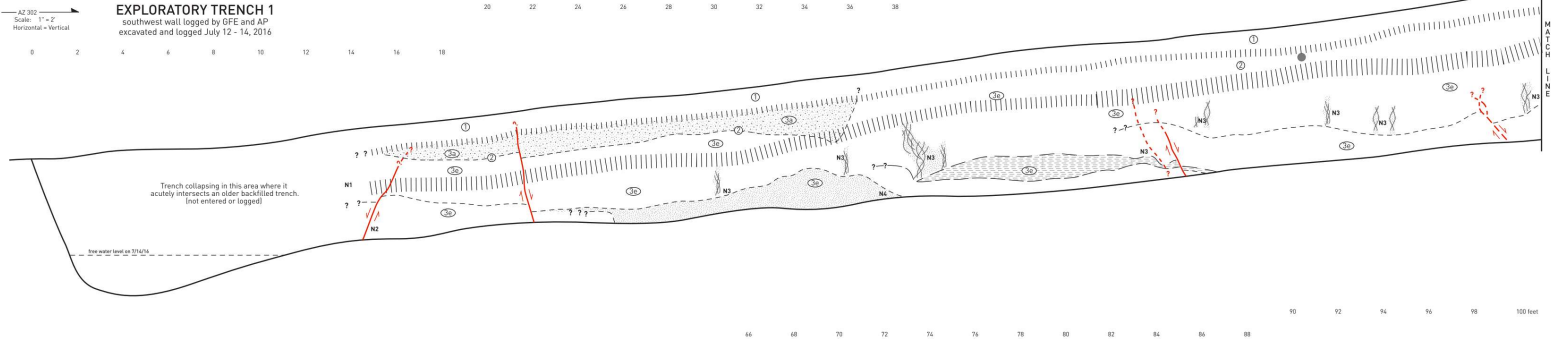

EXPLORATORY TRENCH EXPLANATION

EARTH MATERIALS

Topsoil

① **A soil horizon - Silty Clayey Sand to Sandy Clay** - Light brownish gray (10YR 6/2) to dark grayish brown (10YR 4/2) silty clayey sand with occasional gravel, abundant pans and macropores, poorly to well developed crumb structure (thin) near ground surface, dry, frequent rootlets.

② **B soil horizon - Varying Materials** - Dark brown (7.5YR 4/4), materials vary depending on the composition of the underlying unit; the soil horizon is overprinting, generally well developed with poorly to well developed blocky to prismatic peds, dry.

Watsonville Terrace Deposits - fluvial facies bedrock

③ **Silty Sand with Gravel** - Light yellowish brown (10YR 6/4) with abundant iron oxide staining, silty, clayey, fine to coarse sand with scattered to abundant fine gravel and occasional cobbles, massive to blocky interbedded, matrix supported gravels more abundant in upper portion of unit, some narrow sand-filled fissures penetrate base of unit from below, dry.

④ **Interbedded Sand and Gravelly Sand** - Yellowish brown (10YR 5/3) interbedded gravelly, coarse grained sand, sand with silt and clay, planar to undulatory bedding, fining upward from the base of individual beds, matrix to clay supported, loose, dry to slightly moist, Channel scour and fill deposit.

⑤ **Sandy Clay** - Light brownish gray (2.5Y 6/2) to light yellowish brown (2.5Y 6/4) fine sandy clay to clay with sand, originally horizontal, unit is variably warped due to liquefaction of underlying deposits, abundant through-going desiccation cracks where shallow, dry to slightly moist, stiff, slightly plastic when moist. Floodplain deposit.

⑥ **Silty Sand with Gravel** - Light gray (10YR 7/2) to brownish yellow (10YR 6/6) silty fine to coarse sand with abundant fine gravel at base of unit, dry to slightly moist, local iron oxidation staining.

⑦ **Interbedded Sandy Clay, Clayey Sand, and Sand** - Pale yellow (2.5Y 7/4), Light gray (2.5Y 7/2), and Light olive brown (2.5Y 5/4), interbeds of sandy clay, sand, and clayey sand, plastic, loose, blocky desiccation cracks, thin extensional cracks infilled with very dark brown clayey sand (topsoil), occasional iron oxide staining, slightly moist to moist.

SYMBOLS

Materials contact - dashed where approximate, queried where uncertain.

Gradational contact over length of vertical hachures, queried where uncertain.

Shear, arrows show direction of movement.

Thin, anastomosing sand-filled fissures.

Open burrow.

Krotovina - infilled burrow.

TRENCH 1 NOTES

N1 Very sandy - possible liquefaction features.

N2 Cross-trench trend of offset approximately 218AZ.

N3 Zone of thin, anastomosing sand-filled fissures within highly fractured bedrock.

N4 Groundwater seep from floor of trench.

N5 Desiccation crack infilled with very dark brown clayey sand (topsoil).

N6 Sand-filled fissure, up to 1/4" wide, parallel shear.

N7 White colored fine-grained sand silt beneath clay bed (Unit 3C), also penetrates into clay.

N8 Wide liquefaction-related fissure filled with highly fractured bedrock units.



LOG OF EXPLORATORY TRENCH 1			
Parcel Property Tremblay Lane Watsonville, California Santa Cruz County APN 051-411-20			
Date: 7-14-16	Drawn: 10/16/16	Project #	Drawn: 10/16/16
By: GFE, AP, etc.	Revised:		Sheet: 1 of 1
EASTON GEOLOGY, INC.			
P.O. Box 2033 Santa Cruz, California 95063 831.547.6279			

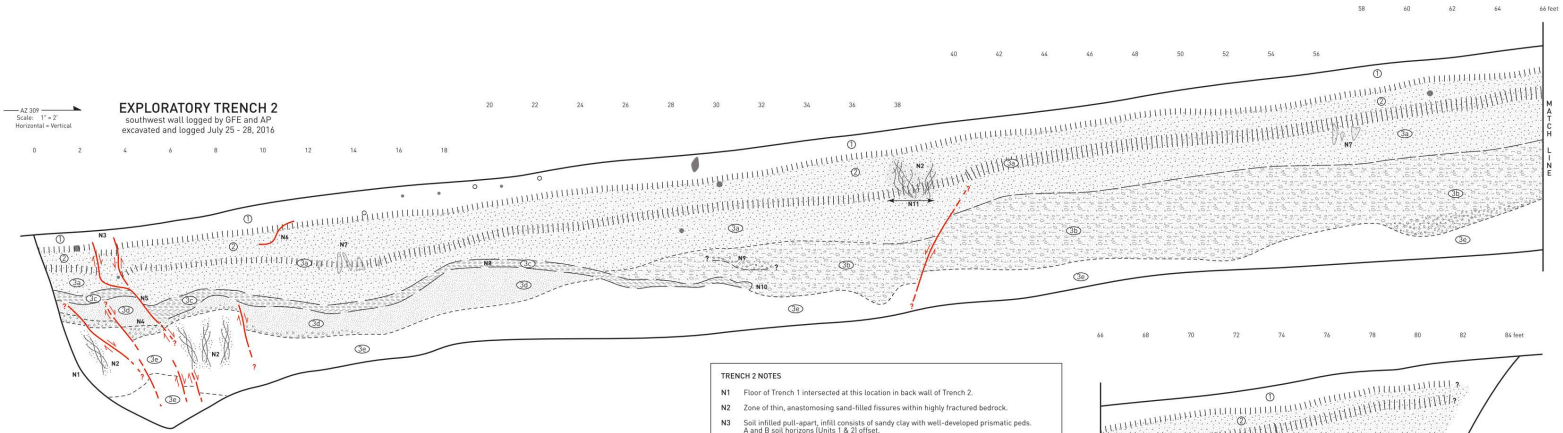

EXPLORATORY TRENCH 2

southwest wall logged by GFE and AP
excavated and logged July 25 - 26, 2016

AZ 209
Scale: 1" = 2'
Horizontal = Vertical

- TRENCH 2 NOTES**
- N1 1/4" wide desiccation cracks infilled with very dark brown clayey sand (topsoil) and roots, indistinct and anastomosing near ground surface.
 - N2 A soil horizon (Unit 1) appears highly mixed and bioturbated within portion of graben.
 - N3 Cross-trench trend of shear - 137AZ.
 - N4 Cross-trench trend of shear - 110AZ (variable).
 - N5 Thin, weakly developed B soil horizon (Unit 2) not mapped.
 - N6 Silt and sand interbeds (Unit 3E) absent due to scour.
 - N7 Zone of thin, anastomosing sand-filled fissures within highly fractured bedrock.
 - N8 Older sand-infilled crack up to 1/2" wide.

- TRENCH 2 NOTES**
- N1 Floor of Trench 1 intersected at this location in back wall of Trench 2.
 - N2 Zone of thin, anastomosing sand-filled fissures within highly fractured bedrock.
 - N3 Silt infilled pull-apart. Infill consists of sandy clay with well-developed prismatic beds. A and B soil horizons (Units 1 & 2) offset.
 - N4 Liquefied sand unit (Unit 3D) thickens and thins across offsets due to volume loss.
 - N5 Unit 3C not distinctly offset on opposite wall nor in wall of overtopping Trench 1; however, unit does warp down on opposite wall on cross-trench trend 205-AZ from offset on logged wall.
 - N6 Open shrink-swell crack.
 - N7 Older sand-infilled fissures or sand intrusions.
 - N8 Unit 3C becomes sandier and less distinct.
 - N9 Interbed not offset.
 - N10 Unit 3C absent due to scour.
 - N11 Zone of cracks, some open and some with soil and root in-fillings.

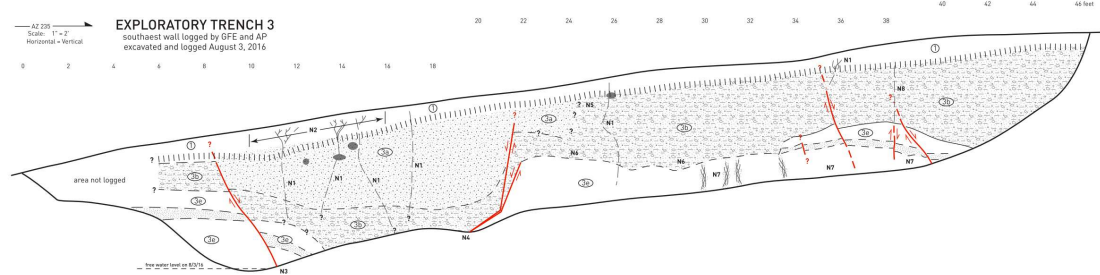
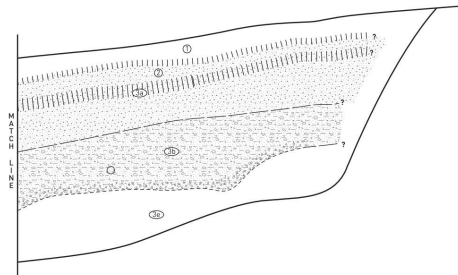

EXPLORATORY TRENCH 3

southeast wall logged by GFE and AP
excavated and logged August 3, 2016

AZ 209
Scale: 1" = 2'
Horizontal = Vertical

- TRENCH 3 NOTES**
- N1 1/4" wide desiccation cracks infilled with very dark brown clayey sand (topsoil) and roots, indistinct and anastomosing near ground surface.
 - N2 A soil horizon (Unit 1) appears highly mixed and bioturbated within portion of graben.
 - N3 Cross-trench trend of shear - 137AZ.
 - N4 Cross-trench trend of shear - 110AZ (variable).
 - N5 Thin, weakly developed B soil horizon (Unit 2) not mapped.
 - N6 Silt and sand interbeds (Unit 3E) absent due to scour.
 - N7 Zone of thin, anastomosing sand-filled fissures within highly fractured bedrock.
 - N8 Older sand-infilled crack up to 1/2" wide.

See Plate 1 for Explanation of Materials and Symbols



LOGS OF EXPLORATORY TRENCHES 2 & 3			
Farmland Property			
Tremblay Lane			
Watsonville, California			
Santa Cruz County APN 051-411-20			
Scale: 1" = 2'	Date: 07/26/16	Project #	01001
By: GFE, AP, etc.	Revised:	01/01/17	PLATE 4
EASTON GEOLOGY, INC.			
P.O. Box 2033 Santa Cruz, California 95063 831.547.6379			

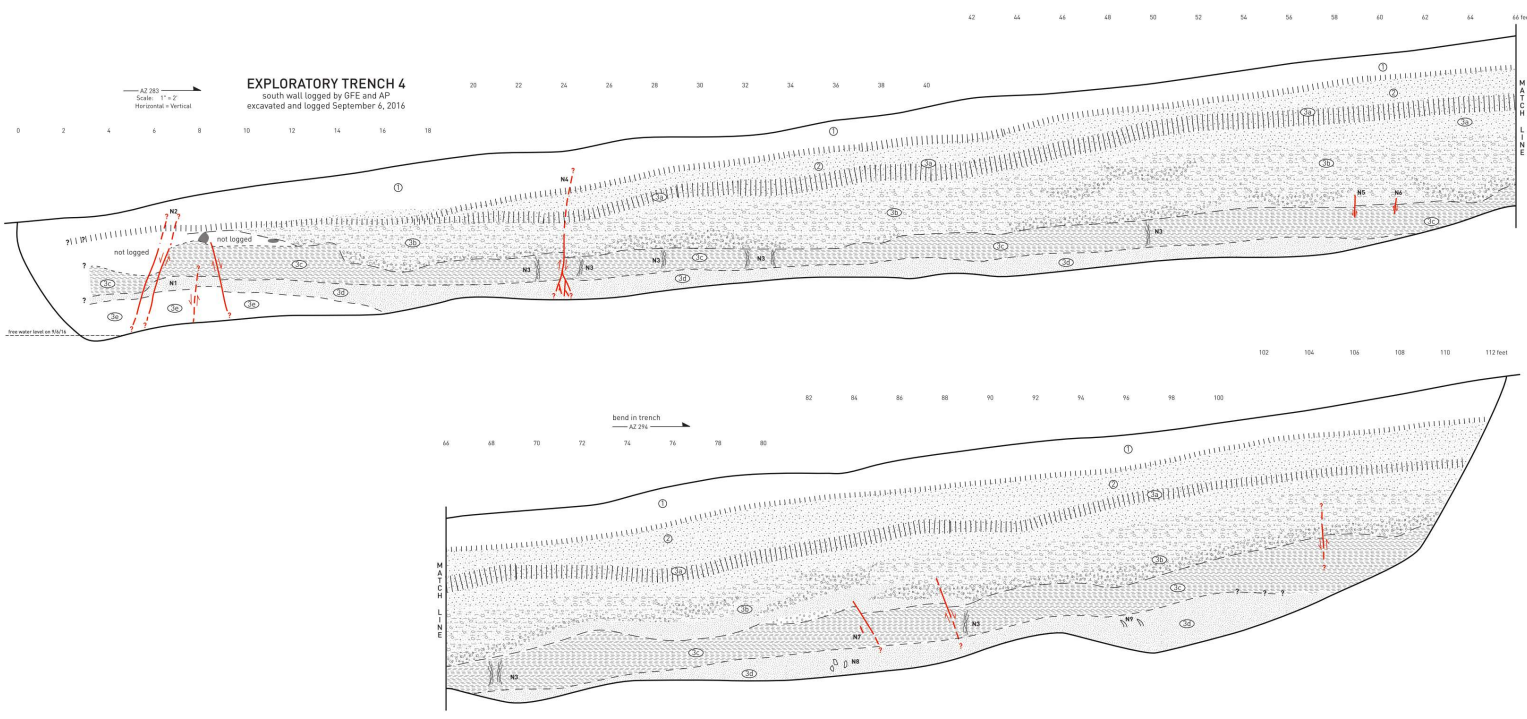

- TRENCH 4 NOTES**
- N1 Highly liquefied zone.
 - N2 A soil horizon (Unit 1) does not appear offset.
 - N3 Zone of thin, anastomosing sand-filled fissures within fractured bedrock.
 - N4 Root-lined desiccation crack consistent with shear below.
 - N5 Contact is offset vertically 1/2 inch.
 - N6 Contact is offset vertically 1/2 inch.
 - N7 Sand filled desiccation crack (fissure?).
 - N8 Older sand-filled fissures or sand intrusions.
 - N9 Soft sediment deformation (flame structures).



See Plate 1 for Explanation of Materials and Symbols

LOG OF EXPLORATORY TRENCH 4			
Farmland Property			
Tremblay Lane			
Watsonville, California			
Santa Cruz County APN 051-411-20			
Scale: 1" = 2'	Date: 07/20/16	Project #	Drawn/Checked
By: GFE, AP, etc.	Revised:	07/20/16	PLATE 5
EASTON GEOLOGY, INC.			
P.O. Box 2033			
Santa Cruz, California 95063			
(831) 542-6279			

EXPLORATORY TRENCH 5
 northeast wall logged by GFE and AP
 excavated and logged October 12, 2016

Scale: 1" = 2'
 Horizontal = Vertical

0 2 4 6 8 10 12 14 16 18 20
 0 2 4 6 8 10 12 14 16 18 20

LOG OF EXPLORATORY TRENCH 5 and GEOLOGIC CROSS SECTION A-A			
Farhat Property Tremblay Lane Watsonville, California Santa Cruz County AGN 051-111-20			
Scale in sheet	Date: 11/08/16	Project #	Sheet Number
By: GFE, AP, etc.	Revised:	10101	PLATE 6
EASTON GEOLOGY, INC. P.O. Box 2022 Kerman, California 93633 817.247.4317			

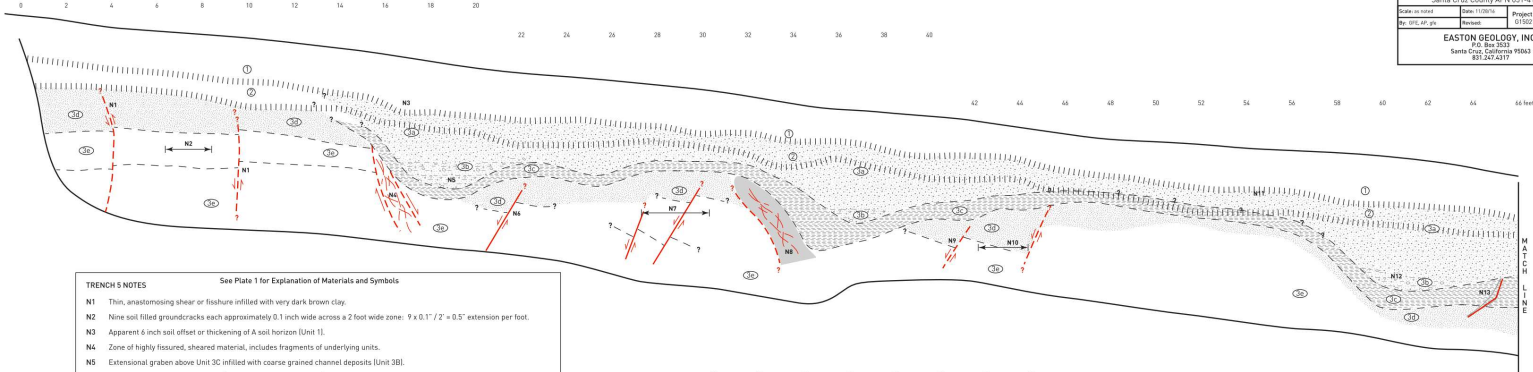

- TRENCH 5 NOTES** See Plate 1 for Explanation of Materials and Symbols
- N1 Thin, anastomosing shear or fissure infilled with very dark brown clay.
 - N2 Nine soil filled groundcracks each approximately 0.1 inch wide across a 2 foot wide zone: $9 \times 0.1' / 2' = 0.5'$ extension per foot.
 - N3 Apparent 6 inch soil offset or thickening of A soil horizon (Unit 1).
 - N4 Zone of highly fissured, sheared material, includes fragments of underlying units.
 - N5 Extensional graben above Unit 3C infilled with coarse grained channel deposits (Unit 3B).
 - N6 4 inch apparent offset along shear (0.2' horizontal, 0.55' vertical).
 - N7 Nineteen soil filled groundcracks each approximately 0.05 inch wide across a 3 foot wide zone: $19 \times 0.05' / 3' = 0.3'$ extension per foot.
 - N8 Wide liquefaction-related fissure filled with highly fractured bedrock units.
 - N9 Apparent offset: 0.7' horizontal, 0.8' vertical.
 - N10 Ten soil filled groundcracks each approximately 0.05 inch wide across a 2 foot wide zone: $10 \times 0.05' / 2' = 0.25'$ extension per foot.
 - N11 Several burrows and Arctostaphylos.
 - N12 Small channel infill similar to Note N5 above.
 - N13 Older sand-infilled fissure or sand intrusion, with orange oxidation staining.
 - N14 Sand-infilled fissure or intrusion, with orange oxidation staining.
 - N15 Apparent offset: 0.2 feet horizontal across both shears.
 - N16 Thirty three soil filled groundcracks each approximately 0.05 inch wide across a 4 foot wide zone: $33 \times 0.05' / 4' = 0.4'$ extension per foot.
 - N17 Bedding is warped - no apparent offset.
 - N18 Twenty six soil filled groundcracks each approximately 0.1 inch wide over 4 foot wide zone: $26 \times 0.1' / 4' = 0.7'$ extension per foot.

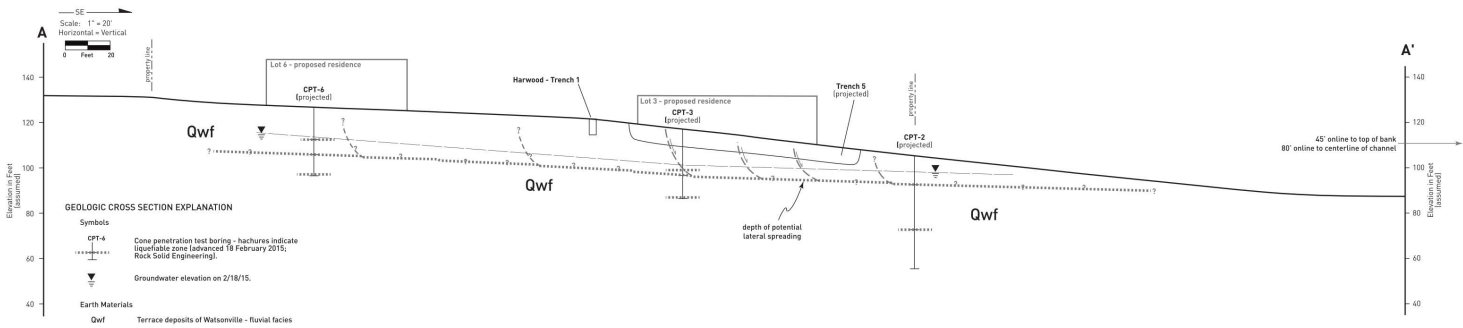
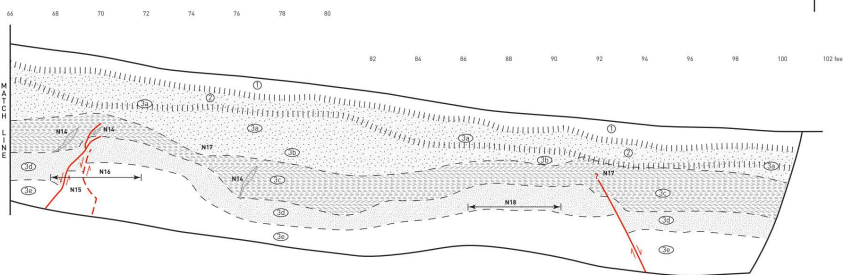

GEOTECHNICAL INVESTIGATION-DESIGN PHASE

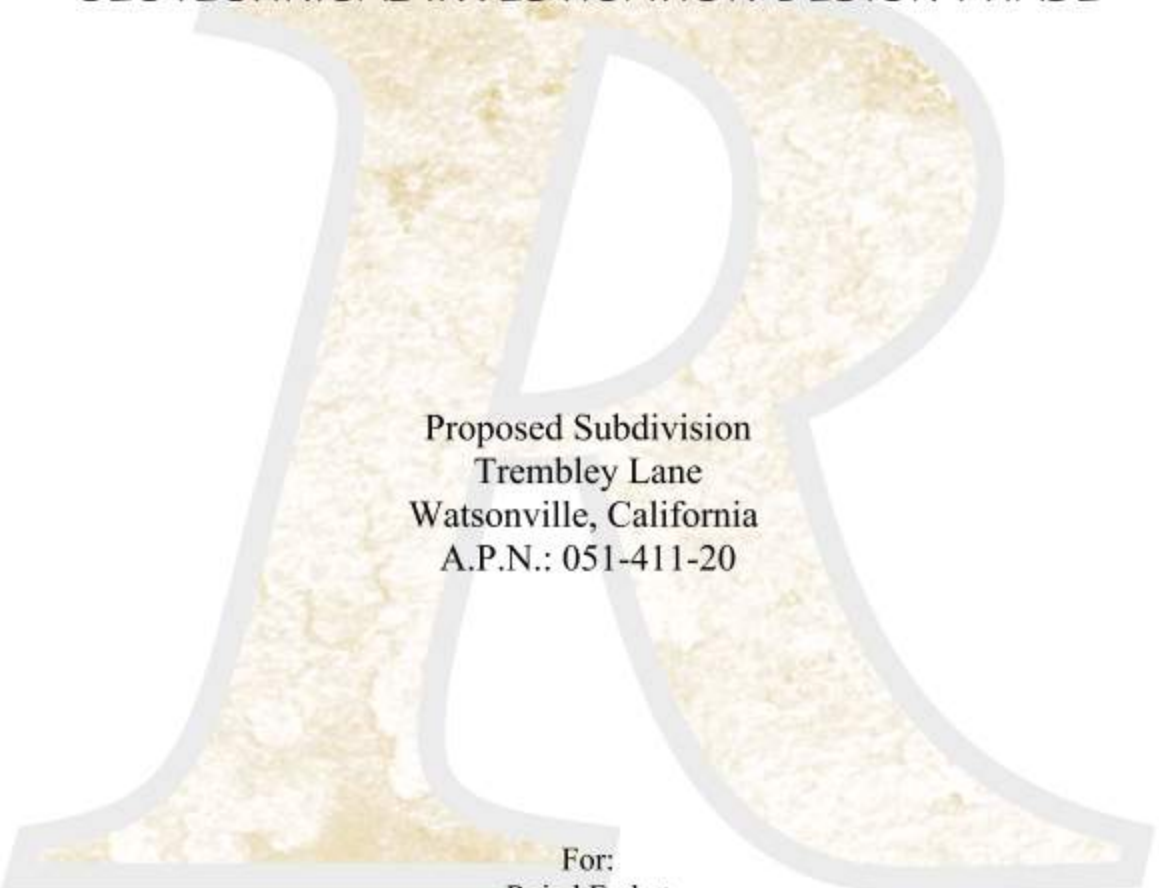

Proposed Subdivision
Trembley Lane
Watsonville, California
A.P.N.: 051-411-20

For:
Raied Farhat
734 East Lake Avenue #9
Watsonville, California 95076

Project No. 14034
December 9, 2016

ATTACHMENT 9

Project No. 14034
December 9, 2016

Raied Farhat
734 East Lake Avenue #9
Watsonville, California 95076

SUBJECT: GEOTECHNICAL INVESTIGATION - DESIGN PHASE
Proposed Subdivision
Trembley Lane, Watsonville, California
APN: 051-411-20

REFERENCES: See Attached

Dear Mr. Farhat:

In accordance with your authorization, we have completed a design phase geotechnical investigation for the proposed subdivision at the corner of Trembley Lane and Cunningham Way, in Watsonville, California. This report summarizes the findings, conclusions, and recommendations from our field exploration, laboratory testing, and engineering analysis. The conclusions and recommendations included herein are based upon applicable standards at the time this report was prepared.

It is a pleasure being associated with you on this project. If you have any questions, or if we may be of further assistance, please do not hesitate to contact our office.

Sincerely,

ROCK SOLID ENGINEERING, INC.



Signed: December 16, 2016

Yvette M. Wilson, P.E.
Principal Engineer
R.C.E. 60245

Distribution: (6) Addressee and via email

TABLE OF CONTENTS

1.	<u>INTRODUCTION</u>	1
1.1	Purpose	1
1.2	Proposed Development	1
1.3	Scope of Services	1
1.4	Authorization	2
2.	<u>FIELD EXPLORATION AND LABORATORY TESTING PROGRAM</u>	2
3.	<u>SITE DESCRIPTION</u>	2
4.	<u>GEOTECHNICAL HAZARDS</u>	3
4.1	General	3
4.2	Liquefaction and Lateral Spreading	3
5.	<u>CONCLUSIONS AND RECOMMENDATIONS</u>	6
5.1	<u>General</u>	6
5.2	<u>Grading</u>	7
5.2.1	General	7
5.2.2	Site Clearing	7
5.2.3	Excavating Conditions	7
5.2.4	Fill Material	8
5.2.5	Fill Placement and Compaction	8
5.2.6	Preparation of On-Site Soils	9
5.2.7	Cut and Fill Slopes	10
5.2.8	Groundwater Table	11
5.2.9	Expansive Soils	11
5.2.10	Sulfate Content	11
5.2.11	Surface Drainage	12
5.2.12	Utility Trenches	13
5.3	<u>Foundations</u>	13
5.3.1	General	13
5.3.2	Rigid Structural Foundations	14
5.4	<u>Settlements</u>	15
5.5	<u>Retaining Structures</u>	15
5.5.1	General	15
5.5.2	Lateral Earth Pressures	16
5.5.3	Backfill	16
5.5.4	Backfill Drainage	17
5.6	<u>Pavement Design</u>	18
5.7	<u>Exterior Concrete Flatwork</u>	18
6.	<u>LIMITATIONS</u>	19
	REFERENCES	20

Appendix A: Field Exploration and Laboratory Testing Program

Appendix B: Liquefaction Analysis

1. INTRODUCTION

1.1 Purpose

The purpose of our investigation is to provide geotechnical design parameters and recommendations for development of the site. Conclusions and recommendations related to site grading, foundations, slabs-on-grade, pavements and retaining structures are presented herein.

1.2 Proposed Development

- a. Based on our conversations with you, it is our understanding that the project consists of the subdivision of the existing parcel into nine new parcels with an access road. The construction of a new single family residence with an attached garage and accessory dwelling unit is planned for each parcel.
- b. Anticipated construction consists of a wood frame structures with raised wood or concrete slab floors. Exact wall, column, and foundation loads are unavailable, but are expected to be typical of such construction.
- c. Final grading and foundation plans were unavailable at the time of this report. It is our understanding that the information obtained during our investigation will be used in the development of a finalized plan set.
- d. Also anticipated, are the construction of attendant driveways, drainage systems and associated landscaping improvements.

1.3 Scope of Services

The scope of services provided during the course of our investigation included:

- a. Review of the referenced geotechnical, geologic, and seismological reports and maps pertinent to the development of the site (available in our files).
- b. Field exploration consisting of 5 borings and 6 CPT soundings advanced in the area of the proposed development.
- c. Logging and sampling of the borings by our Field Engineer, including the collection of soil samples for laboratory testing.
- d. Laboratory testing of soil samples considered representative of subsurface conditions.
- e. Geotechnical analyses of field and laboratory data.
- f. Preparation of a report (6 copies) presenting our findings, conclusions and recommendations.

1.4 Authorization

This investigation, as outlined in our Proposal dated June 16, 2014, was performed in accordance with your written authorization on June 18, 2014. The additional services were performed in accordance with your written authorization on March 16, 2015.

2. FIELD EXPLORATION AND LABORATORY TESTING PROGRAM

Details of the field exploration and laboratory testing are presented in Appendix A.

3. SITE DESCRIPTION

3.1 Location

The subject project is located at the southeast corner of the intersection of Trembley Lane and Cunningham Way, in Watsonville, Santa Cruz County, California. The location is shown on the Location Map, **Figure 1**.

3.2 Surface Conditions

The subject site slopes down gently to the south and east with an average gradient of 8:1 (H:V). The parcel is currently clear of all development.

3.3 Subsurface Conditions

- a. Perched groundwater was encountered during the course of our field exploration at approximately 5 feet below the existing grade, at its closest elevation to the ground surface. The groundwater was observed to be traveling through sandier strata throughout our borings. Groundwater and wet conditions are noted on the boring and CPT logs, **Figures A-3 through A-13**.
- b. The topsoil consists of orange brown sandy silt. The sandy silt was observed from the surface to between 6 inches and 1 foot below existing grade. This material is generally dry and medium plastic.
- c. Underlying the sandy silt stratum, inter-bedded layers of clay, clayey sand, sand and silt were encountered. This profile is consistent with the mapped Terrace Deposits of Watsonville, fluvial facies.
- d. Based on our laboratory test results, the near surface soil is moderately compressible under the anticipated loads.
- e. Based on our laboratory test results, **the near surface clays are very highly expansive** upon wetting while the near surface clayey sands have a low potential for expansion.



REFERENCE: The Thomas Guide, 2004.

ROCK SOLID ENGINEERING, INC.

LOCATION MAP

FIGURE

Trembley Lane, Watsonville

1

- f. Complete soil profiles are presented on the Logs of Exploratory Borings and CPT Logs. The locations are shown on the Boring Location Plan in Appendix A.

4. GEOTECHNICAL HAZARDS

4.1 General

- a. Potential geotechnical hazards to man made structures include ground shaking, surface rupture, landsliding, liquefaction, lateral spreading, and differential compaction. The potential for ground shaking, surface rupture and landsliding to impact the site is discussed in the Geologic Investigation prepared for the project by Easton Geology, Inc. (Reference 5). The seismic design criteria and potential for liquefaction is discussed below.
- b. The subject site is situated at the approximate latitude of 36°57' 26" and longitude -121°45' 35". The project location (latitude and longitude) were used in conjunction with the U.S. Geologic Survey website (Reference 11) to obtain the seismic design parameters presented in **Table 1**. All proposed structures at the subject site shall be designed with the corresponding seismic design parameters in accordance with the 2013 California Building Code (Reference 2).

Table 1
2013 CBC Seismic Design Criteria

SEISMIC DESIGN CRITERIA							
Site Class	Seismic Design Category	Spectral Response Accelerations					
		S _s	S ₁	S _{M_s}	S _{M₁}	S _{D_s}	S _{D₁}
D	E	2.414	0.979	2.414	1.469	1.609	0.979

- c. Liquefaction, lateral spreading, and differential compaction tend to occur in loose, unconsolidated, noncohesive soils with shallow groundwater. During our field exploration, relatively loose, non-cohesive soils were observed below the groundwater level and a quantitative liquefaction analysis was deemed necessary. The The results of our analysis are presented in Section 4.2 of this report, and the methodology and calculations are presented in Appendix B.

4.2 Liquefaction and Lateral Spreading

4.2.1 Liquefaction

- a. The CPT soundings were advanced to get more detailed soil profiles for the liquefaction analysis.

- b. The liquefaction analysis uses empirical predictions of earthquake-induced liquefaction potential and was performed using the software NovoCPT (Reference 8).
- c. The soil stratum is generally composed of thin sandy layers interbedded with clayey silts and clays. The sandy strata encountered below the groundwater table were generally characteristic of potentially liquefiable soil.
- d. Based on our review of the results of the CPT soundings and the geologic trenches, the soil strata tend to be of variable thickness and are laterally discontinuous.
- e. The results of our quantitative liquefaction analysis indicate that the underlying sandy layers situated below the groundwater level are **susceptible** to liquefaction during the design seismic event.
- f. We have calculated the resulting vertical surface deformation due to liquefaction during the design seismic event to be approximately 0.5 to 1.5 inches. This settlement can occur beneath the entire structure, or differentially, across the least dimension of the structure. The liquefaction calculations are presented in Appendix B.

4.2.2 Lateral Spreading

- a. Easton Geology excavated several exploratory trenches on the site. The trenches revealed evidence of previous liquefaction and lateral spreading. However, no evidence of large scale flow type failures were observed in the geologic trenches.
- b. The available methods for calculating lateral spread are generally based on gently sloping conditions (0.2% to 3.5%) or a free face such as a river channel. As the methods were developed with a limited range of data based from previous earthquakes, the methods are not recommended for values beyond the specified range.
- c. The site slopes generally range from 3.5% on the northwest upper portion of the parcel to between 10.5% and 12.3% at the southeast lower portion property. Lateral spread was calculated using the available methods (Reference 8) for the portion of the site with a slope of 3.5%. However, the results yield calculated lateral displacements of up to 37 inches. The results are inconsistent with the displacements noted in the geologic trenches as significantly less displacements were noted from the geologic trenches especially on the gently sloping portions of the parcel.

- d. As the available methods for lateral displacement are not recommended for inputs greater than 3.5% slope and there is not a significant free face, it was agreed by our firm, the geologist and the reviewing jurisdiction that the best estimate of future surface deformations would be determined by measuring the vertical and horizontal offsets observed in the trenches.
- e. The observed offsets were summed by the project geologist to arrive at an estimate of the potential offsets for design purposes. Individual observed vertical offsets were measured and cumulative extensional offsets across a set distance were summed to arrive at the distributed horizontal extension per lineal foot across the building sites.
- f. Based on the offset measurements, Easton Geology has recommended that the proposed structures be designed for the following liquefaction induced surface deformations:
 - (a) All Lots: Vertical settlements up to 6 inches
 - (b) Lots 2 through 6: Distributed horizontal extension up to **1 inch per foot** across building pads
 - (c) Lots 1, 7, 8 and 9: Distributed horizontal extension up to **1/2 inch per foot** across building pads

4.2.3 Discussion

- a. It must be cautioned that liquefaction analysis is an inexact science and the empirical predictions of earthquake-induced liquefaction potential are based on a comparison of the subject site with areas that have experienced liquefaction. The soil configuration analyzed contains many simplifying assumptions, not the least of which are isotropy and homogeneity. Soil strata deemed “susceptible” to liquefaction during the design seismic event will not necessarily liquefy, but the probability will be greater than a stratum deemed “not susceptible”.
- b. Significant variations in the proposed grades may require that our analysis and the recommendations herein be reviewed and if necessary, amended.
- c. Further discussion of our liquefaction analysis, methodology, and calculations are presented in Appendix B.

5. CONCLUSIONS AND RECOMMENDATIONS

5.1 General

- a. Based on the results of our investigation, it is our opinion that from the geotechnical standpoint, the subject site will be suitable for the proposed subdivision. Recommendations are presented herein.
- b. To mitigate the potential surface deformations due to liquefaction, the proposed structures shall be founded on **structural mat slabs** or **grade beam waffle type foundations**. Recommendations for these foundation systems are provided in Section 5.3, Foundations.
- c. Site preparation, consisting of over excavation and recompaction of the native subgrade with stabilization fabric will be required prior to placement of shallow foundations, slabs-on-grade and pavements. **See Section 5.2.6** for Preparation of On-Site Soil recommendations.
- d. At the time we prepared this report, grading and foundation plans had not been finalized. We request an opportunity to review these plans during the design stages to determine if supplemental recommendations will be necessary.
- e. The design recommendations of this report must be reviewed during the grading phase when subsurface conditions are exposed.
- f. **Field observation and testing must be provided by a representative of Rock Solid Engineering, Inc.**, to enable them to form an opinion regarding the adequacy of the site preparation, and the extent to which the earthwork is performed in accordance with the geotechnical conditions present, the requirements of the regulating agencies, the project specifications and the recommendations presented in this report. Any earthwork performed in connection with the subject project without the full knowledge of, and not under the direct observation of Rock Solid Engineering, Inc., the Geotechnical Consultant, will render the recommendations of this report invalid.
- g. **The Geotechnical Consultant should be notified at least five (5) working days prior to any site clearing or other earthwork operations** on the subject project in order to observe the stripping and disposal of unsuitable materials and to ensure coordination with the grading contractor. During this period, a preconstruction conference should be held on the site to discuss project specifications, observation/testing requirements and responsibilities, and scheduling. This conference should include at least the Grading Contractor, the Architect, and the Geotechnical Consultant.

5.2 Grading

5.2.1 General

All grading and earthwork should be performed in accordance with the recommendations presented herein and the requirements of the jurisdictions.

5.2.2 Site Clearing

- a. Prior to grading, the areas to be developed for structures, pavements and other improvements, should be stripped of any vegetation and cleared of any surface or subsurface obstructions, including any existing foundations, utility lines, basements, septic tanks, pavements, stockpiled fills, and miscellaneous debris.
- b. All pipelines encountered during grading should be relocated as necessary to be completely removed from construction areas or be capped and plugged according to applicable code requirements.
- c. Any wells encountered shall be capped in accordance with **Santa Cruz County** Health Department requirements. The strength of the cap shall be at least equal to the adjacent soil and shall not be located within 5 feet of any structural element.
- d. Surface vegetation and organically contaminated topsoil should be removed from areas to be graded. The required depth of stripping will vary with the time of year the work is done and must be observed by the Geotechnical Consultant. It is generally anticipated that the required depth of stripping will be 6 to 12 inches.
- e. Holes resulting from the removal of buried obstructions that extend below finished site grades should be backfilled with compacted engineered fill per section 5.2.5.

5.2.3 Excavating Conditions

- a. We anticipate that excavation of the on-site soils may be accomplished with standard earthmoving and trenching equipment.
- b. Perched groundwater was encountered during the course of our field exploration at varying depths, the minimum of which is approximately 5 feet below the existing grade. The water was observed to be traveling through sandier stratum throughout our borings. Groundwater levels fluctuate based on the time of year and rainfall. It should be noted that our field exploration took place during the summer and during a period of severe drought. Groundwater levels may rise especially after periods of rain.

- c. Although not anticipated, any excavations adjacent to existing structures should be reviewed, and recommendations obtained to prevent undermining or distress to these structures.

5.2.4 Fill Material

- a. The highly expansive on-site clays **may not** be used as compacted fill in structural areas and fill slopes. The site soils that have a low potential for expansion may be used as fill provided they are separated from the expansive clays and additional testing is done during construction to verify the expansion index.
- b. All soils, both on-site and imported, to be used as fill, should contain less than 3% organics and be free of debris and cobbles over 6 inches in maximum dimension.
- c. Any imported soil to be used as engineered fill shall meet the following requirements:
 - (i) free of organics, debris and other deleterious materials
 - (ii) be granular (sandy) in nature and have sufficient fines to allow for excavation of the foundation trenches.
 - (iii) free of rock and cobbles in excess of 3 inches
 - (iv) have an expansion potential not greater than low ($EI < 20$)
 - (v) have a soluble sulfate content less than 150 ppm
- d. Imported fill material should be approved by the Geotechnical Consultant prior to importing. The Geotechnical Consultant should be notified not less than 5 working days in advance of placing any fill or base course material proposed for import. Each proposed source of import material should be sampled, tested and approved by the Geotechnical Consultant prior to delivery of any soils imported for use on the site.

5.2.5 Fill Placement and Compaction

- a. Any fill or backfill required should be placed in accordance with the recommendations presented below.
- b. Material to be compacted or reworked should be moisture-conditioned or dried to achieve near-optimum conditions, and compacted to achieve the following minimum relative compaction:
 - (a) All fill and compacted building subgrade: 90%
 - (b) Upper 6 inches of subgrade in pavement/drive areas: 95%
 - (c) Baserock and subbase: 95%.

- c. The placement moisture content of imported material should be evaluated prior to grading.
- d. The relative compaction and required moisture content shall be based on the maximum dry density and optimum moisture content obtained in accordance with ASTM D-1557.
- e. The in-place dry density and moisture content of the compacted fill shall be tested in accordance with ASTM D-6780 or ASTM D-2922/ASTM D-3017.
- f. The number and frequency of field tests required will be based on applicable county standards and at the discretion of the Geotechnical Consultant. As a minimum standard every 1 vertical foot of engineered fill placed within a building pad area, and every 2 vertical feet in all other areas shall be tested, unless specified otherwise by a Rock Solid Engineering, Inc. representative.
- g. Fill should be compacted by mechanical means in uniform horizontal loose lifts not exceeding 8 inches in thickness.
- h. All fill should be placed and all grading performed in accordance with applicable codes and the requirements of the regulating agency.

5.2.6 Preparation of On-Site Soils

- a. In order to help mitigate the potential surface deformations due to liquefaction and lateral spreading, all structures shall be constructed on **level** building pads created with reinforced fill as follows.
- b. The subgrade beneath the structures shall be excavated to a depth of 6 feet below finished grade. A layer of HP 570 stabilization fabric shall be installed at the bottom of the excavation. The native soils (with the exception of the clays) may then be placed on top of the fabric and compacted in lifts. A minimum of 3 layers of stabilization fabric shall be installed spaced 2 feet apart vertically. See **Figure 2**.
- c. Where the highly expansive clay is encountered below buildings, slabs and pavements, **the clay shall be removed and replaced** with native or import with an expansion potential not higher than **low**.
- d. Multiple geologic trenches (Easton and Harwood) have been excavated on this parcel and were loosely backfilled upon completion. The location of all of the geologic trenches shall be shown on the improvement plans. During the project grading, the **loose backfill will need to be removed and replaced as compacted engineered fill** in accordance with Section 5.2.5.

REINFORCED FILL PAD

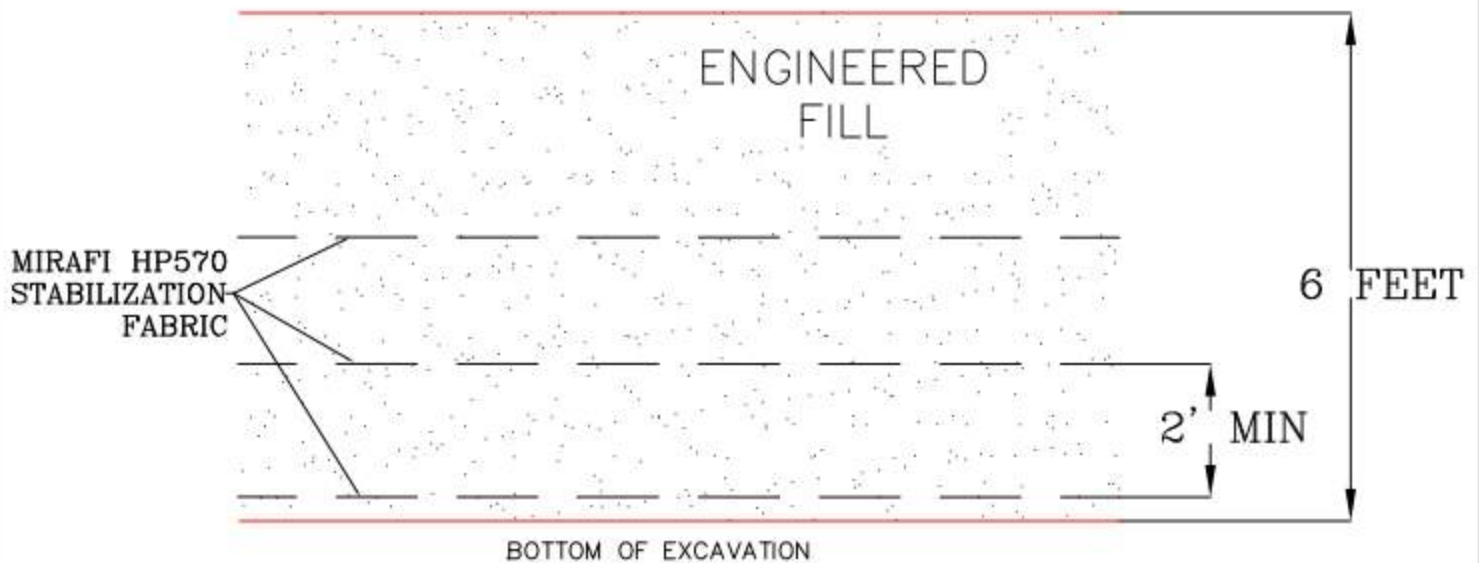

NOTES:

REINFORCED FILL PAD MUST BE CONSTRUCTED UNDER ALL PORTIONS OF ALL HABITABLE STRUCTURES. PAD SHALL EXTEND MINIMUM OF 5 FEET BEYOND THE BUILDING FOOTPRINT.

PLACE MIRAFI HP570 AS SHOWN. MINIMUM OF 3 LAYERS OF FABRIC. SPACED EVERY 2 FEET VERTICALLY. INSTALL FABRIC PER MANUFACTURER'S INSTRUCTIONS.

MINIMUM 1 FOOT SEPARATION BETWEEN BOTTOM OF FOOTING AND FABRIC.

ALTERNATE DIRECTION OF FABRIC FROM LAYER TO LAYER.

COMPACT NATIVE SOILS BETWEEN LAYERS OF FABRIC. MINIMUM 90% RELATIVE COMPACTION.

ALL RECOMMENDATIONS ARE SUBJECT TO REVIEW BY THE SOILS ENGINEER DURING GRADING.

- e. The native subgrade beneath **pavements** should be reworked to a depth sufficient to provide a zone of compacted fill extending at least 12 inches below the bottom of aggregate base coarse.
- f. A representative of our firm shall observe the bottom of the excavation once the required depth of overexcavation has been achieved to verify suitability. Prior to replacing the excavated soil, the exposed surface should be scarified to a depth of 6 to 8 inches, moisture conditioned, and compacted.
- g. The depths of reworking required are subject to review by the Geotechnical Consultant during grading when subsurface conditions become exposed.

5.2.7 Cut and Fill Slopes

- a. The **highly expansive native clay soils may not be used** to create fill slopes.
- b. All fill slopes should be constructed with engineered fill meeting the minimum density requirements of this report and have a gradient no steeper than 2:1 (horizontal to vertical).
- c. Should steeper slopes be necessary, they may be created with reinforced fill slopes using geofabric. Please contact our office if such slopes are required.
- d. Fill slopes should not exceed 15 feet in vertical height unless specifically reviewed by the Geotechnical Consultant. Where the vertical height exceeds 15 feet, intermediate benches must be provided. These benches should be at least 6 feet wide and sloped to control surface drainage. A lined ditch should be used on each bench.
- e. Fill slopes shall be benched and keyed into the native slopes by providing a base keyway whose minimum width is 10 feet and which is sloped negatively at least 2% back into the slope. The depth of keyways will vary, depending on the materials encountered, but at all locations shall be at least 2 feet into firm material. This keyway should be combined with intermediate benching as required. Refer to **Figure 3** for Typical Key and Bench Detail.
- f. Because of the shallow perched water encountered at various depths, we anticipate the need for a keyway drain and bench drains at fill slopes. Refer to **Figure 4** for Keyway/Bench Drain Typical Detail.

FILL SLOPE OVER NATIVE SOIL

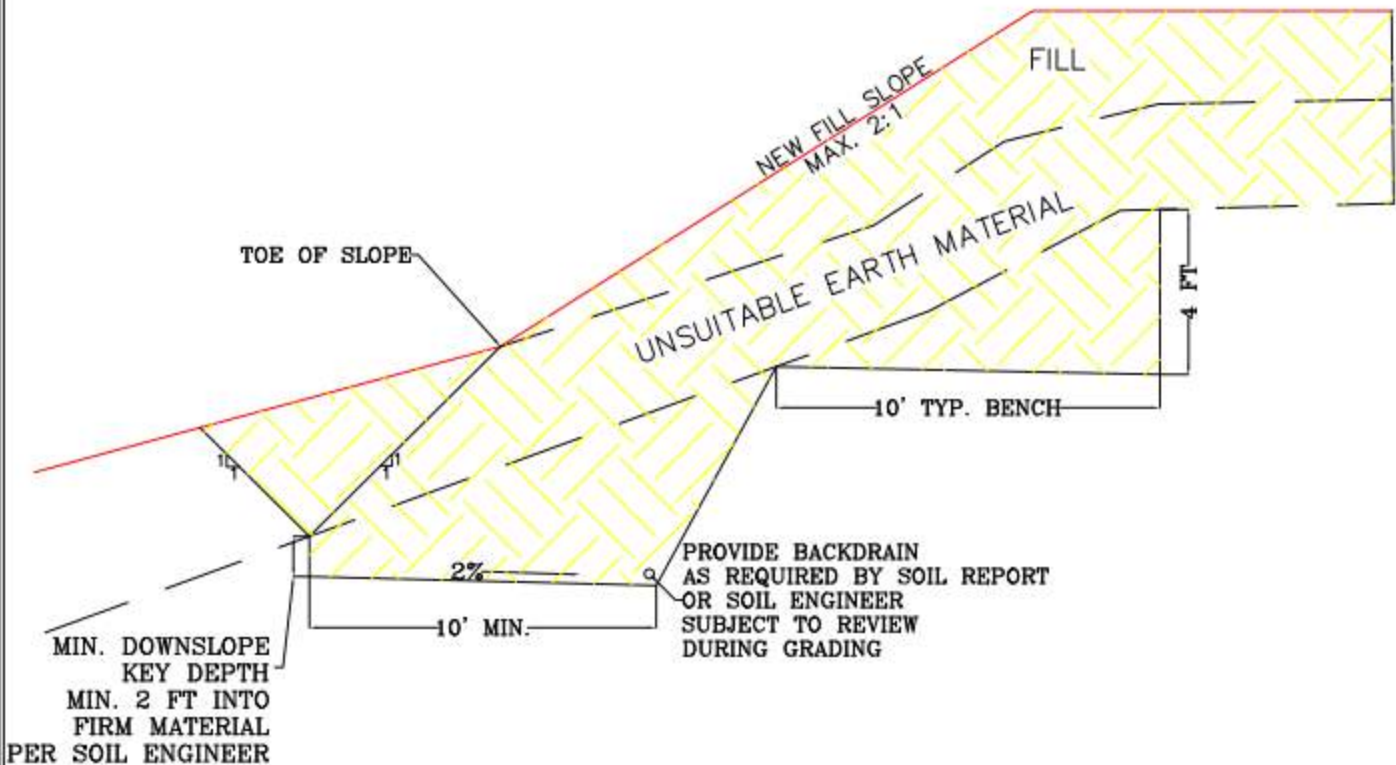

NOTES:

ALL GRADING SHOULD BE IN ACCORDANCE WITH THE LOCAL JURISDICTION REQUIREMENTS AND THE 2013 CALIFORNIA BUILDING CODE.

ALL GRADING SHOULD BE INSPECTED BY THE SOIL ENGINEER. THE ENGINEER MUST APPROVE THE BASE KEYWAY, BENCHING AND COMPACTION.

WHEN NATURAL SLOPE IS LESS THAN 5:1, BENCHING IS NOT REQUIRED. HOWEVER, FILL IS NOT TO BE PLACED ON COMPESSIBLE OR UNSUITABLE MATERIAL.

ALL GRADING RECOMMENDATIONS ARE SUBJECT TO REVIEW BY THE SOILS ENGINEER DURING GRADING.

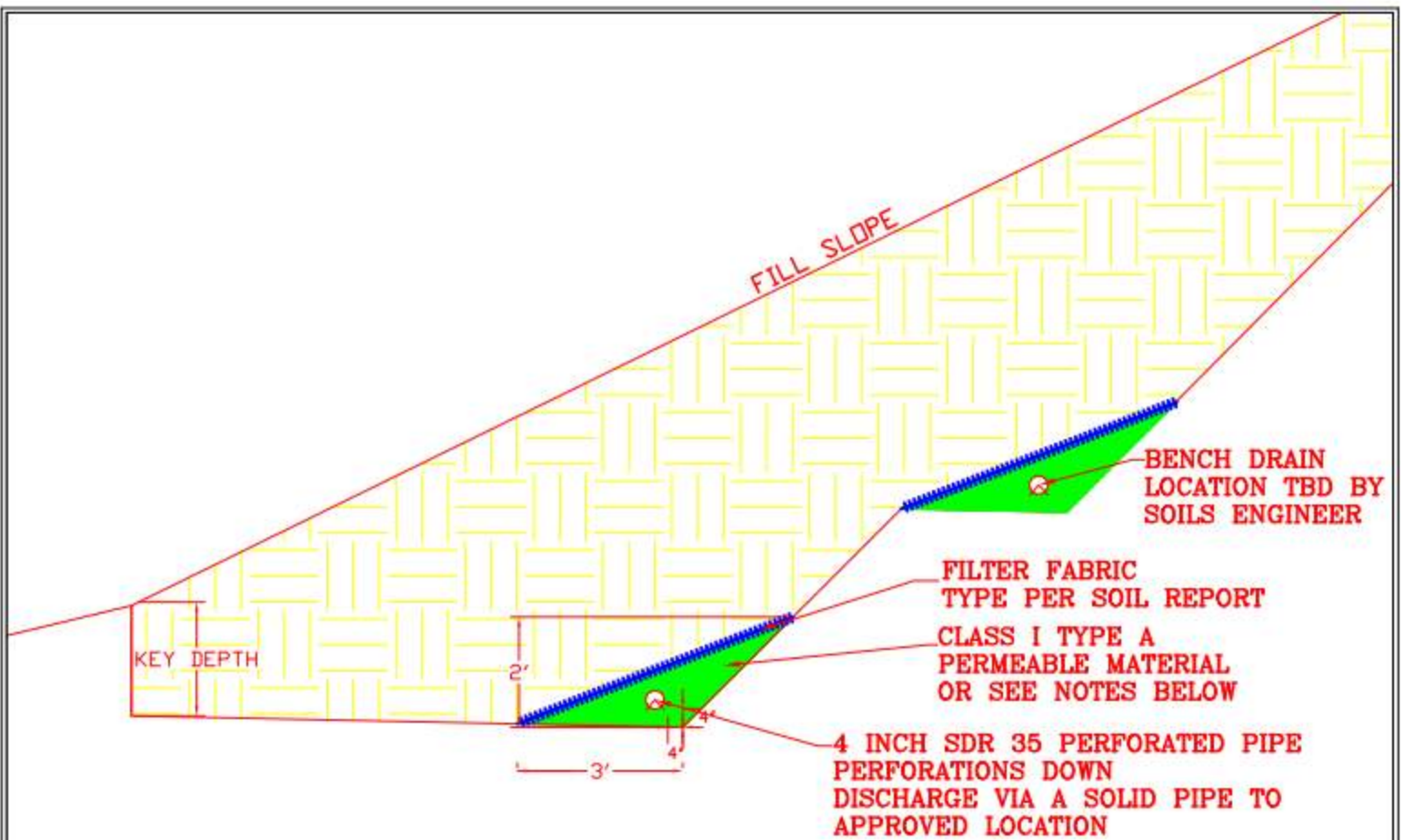

NOTES:

Rock and Fabric Options

- Class 1 Type A, with Specified Filter Fabric Over Top of Material
- Class 2 Material (No Fabric Required)
- Clean Crushed Rock Wrapped in Filter Fabric (Per Report). Fabric Must be Overlapped A Minimum of 2 Feet

A Representative of Rock Solid Engineering, Inc. Must Observe Drain Pipe Prior to Covering Discharge Location to Be Shown on Plans.

Uphill Ends of The Drain Pipe Must Be Capped

- g. Cut slopes shall not exceed a 2:1 (horizontal to vertical) gradient and a 15 foot vertical height unless specifically reviewed by the Geotechnical Consultant. Where the vertical height exceeds 15 feet, intermediate benches must be provided. These benches should be at least 6 feet wide and sloped to control surface drainage. A lined ditch should be used on each bench.
- h. If a fill slope is to be placed above a cut slope, the toe of the fill slope should be set back at least 8 feet horizontally from the top of the cut slope. A lateral surface drain should be placed in the area between the cut and fill slopes.
- i. The surfaces of all cut and fill slopes should be worked to reduce erosion. This work, as a minimum, should include track rolling of the fill slopes and effective planting of all slopes.
- j. Periodic maintenance of slopes may be necessary, as minor sloughing and erosion may take place.

5.2.8 Groundwater Table

Perched groundwater was encountered during the course of our field exploration at varying depths, the minimum of which is approximately 5 feet below the existing grade.

The water was observed to be traveling through sandier stratum throughout our borings. Groundwater depths may vary depending on the amount of recent rainfall, especially at the lower elevations of the site.

5.2.9 Expansive Soils

Our laboratory testing shows that the expansion index of the near surface soils are equal to 41 and 155, this indicates that the expansion potential of the near surface soils should be considered **low to very high**.

The California Building Code (Section 1803.5.3) defines soils with an Expansion Index greater than 20 to be expansive. The foundation and grading recommendations presented herein are intended to be in accordance with CBC Section 1808.6.

5.2.10 Sulfate Content

The results of our laboratory testing indicate that the soluble sulfate content of the on-site soils likely to come into contact with concrete is below the 150 ppm generally considered to constitute an adverse sulfate condition. **Type II cement** is therefore considered adequate for use in concrete in contact with the on-site soils.

5.2.11 Surface Drainage

- a. The lot shall be graded to drain surface water away from foundation walls. The grade shall fall a minimum of **6 inches within the first 10 feet (5 percent)**. If 10 horizontal feet can not be satisfied due to lot lines or physical constraints, the drainage shall be designed in accordance with the requirements of Section R401.3 of the 2013 California Residential Code.
- b. Swales and impervious surfaces shall be sloped a minimum of 2 percent towards an approved drainage inlet or discharge point or as specified by the Project Civil Engineer.
- c. All roof eaves should be guttered with downspouts provided. The downspouts shall discharge to either splash blocks or solid pipe to carry the storm water away from the structure to reduce the possibility of soil saturation and erosion. It may be necessary to use swales or pipes to direct the runoff to an appropriate drainage system or discharge location.
- d. Concentrated runoff shall not be allowed to discharge on to fill slopes.
- e. Because of the perched groundwater conditions, we recommend that the pad grade beneath the house be at the same elevation as the exterior grade. Should the pad grade be lower than the exterior grade, footing drains may be necessary.
- f. Drainage patterns approved at the time of construction should be maintained throughout the life of the structures. The building and surface drainage facilities must not be altered nor any grading, filling, or excavation conducted in the area without prior review by the Geotechnical Consultant.
- g. The surface soils are classified as **moderately erodible**. Therefore, the finished ground surface should be planted with erosion resistant landscaping and ground cover and continually maintained to minimize surface erosion.
- h. Irrigation activities at the site should be controlled and reasonable. Planter areas should not be sited adjacent to walls without implementing approved measures to contain irrigation water and prevent it from seeping into walls and under foundations and slabs-on-grade. Large trees should be planted **a minimum distance of ½ their mature height away from the foundation**.

5.2.12 Utility Trenches

- a. Utility lines shall be designed for the anticipated surface deformations per Section 4.2.2. This may require the use of flexible connections.
- b. Bedding material may consist of sand with SE not less than 20 which may then be jetted, unless local jurisdictional requirements govern.
- c. Existing on-site soils, with the exception of the highly expansive clays, **may** be utilized for trench backfill.
- d. If sand is used, a 3 foot concrete plug should be placed in each trench where it passes under the exterior footings.
- e. Backfill of all exterior and interior trenches should be placed in thin lifts and mechanically compacted to achieve a relative compaction of not less than 95% in paved areas and 90% in other areas per ASTM D-1557. Care should be taken not to damage utility lines.
- f. Utility trenches that are parallel to the sides of a building should be placed so that they do not extend below a line sloping down and away at an inclination of 2:1 (H:V) from the bottom outside edge of all footings.
- g. Trenches should be capped with 1.5± feet of impermeable material. Import material must be approved by the Geotechnical Consultant prior to its use.
- h. Trenches must be shored as required by the local regulatory agency, the State Of California Division of Industrial Safety Construction Safety Orders, and Federal OSHA requirements.

5.3 Foundations

5.3.1 General

- a. It is our opinion that the subject site will be suitable for the support of the proposed structures on **rigid structural mat slabs** or **grade beam waffle** type foundations.
- b. At the time we prepared this report, grading and foundation plans had not been finalized. We request an opportunity to review these plans during the design stages to determine if supplemental recommendations will be necessary.

5.3.2 Rigid Structural Foundations

- a. Based on the results of this investigation and the geologic investigation, we recommend this foundation systems be **designed for:**
 - a. All Lots: Vertical settlements up to 6 inches and a total loss of soil support over an area with an 8 feet diameter occurring an any point beneath the structure.
 - b. Lots 2 through 6: Distributed horizontal extension up to **1 inch per foot** across building pads.
 - c. Lots 1, 7, 8 and 9: Distributed horizontal extension up to **1/2 inch per foot** across building pads.
- b. The foundation may consist of a rigid mat slab or grade beam waffle type with continuous footings connected in a grid pattern.
- c. If a grade beam waffle foundation system is used, we recommend a maximum span of 15 feet between grade beam connections.
- d. Minimum embedment depth for footings shall be 12 inches or as specified by the Structural Engineer. However, we suggest limiting the embedment depth of footings as a minimum of 1 foot of separation will be required between the bottom of footings and the reinforcing fabric. Per Section 5.2.6 and Figure 2.
- e. The foundation system shall have a uniform allowable bearing not exceeding **1,500 psf**.
- f. **The modulus of subgrade reaction (k_s) is 225 lb/in³** for the native soils anticipated to be used as engineered fill below the rigid mat.
- g. Actual slab thickness, reinforcement and doweling should be determined by the Project Structural Engineer.
- h. The subgrade beneath all foundations shall be reinforced fill per the recommendations in Section 5.2.6. The subgrade should be proof-rolled just prior to construction to provide a firm, relatively unyielding surface, especially if the surface has been loosened by the passage of construction traffic.

- i. It is important that the subgrade soils be thoroughly saturated for 24 to 48 hours prior to the time the concrete is poured. **For compacted engineered fill with a medium expansion potential, the subgrade should be presoaked 4 percentage points above optimum to a depth of 1.5 feet.**
- j. The slab-on-grade section should incorporate a minimum 4 inch capillary break consisting of 3/4 inch, clean, crushed rock, or approved equivalent. Class II baserock is not recommended. Structural considerations may govern the thickness of the capillary break.
- k. Where moisture sensitive floor coverings are anticipated or vapor transmission may be a problem, a 15 mil waterproof membrane should be placed between the floor slab and the capillary break in order to reduce moisture condensation under the floor coverings.

5.4 Settlements

- a. Total and differential settlements beneath foundation elements due to static loading are expected to be within tolerable limits. Vertical movements are not expected to exceed 1 inch. Differential movements are expected to be within the normal range (1/2 inch) for the anticipated loads and spacings. These preliminary estimates should be reviewed by the Geotechnical Consultant when foundation plans for the proposed structures become available.
- b. Potential settlement due to liquefaction and lateral spreading at the subject site during the design seismic event is estimated to be approximately 6 inches. This settlement can occur beneath the entire structure, or differentially, across the least dimension of the structure. Details of our liquefaction analysis are presented in Section 4.2 and Appendix B.

5.5 Retaining Structures

5.5.1 General

We request the opportunity to review the location of any proposed retaining walls. The earthwork and design criteria may need to be refined based on the location of proposed walls.

Retaining walls may be founded on **conventional shallow footings** with an allowable bearing capacity of 1,500 psf.

5.5.2 Lateral Earth Pressures

- a. The lateral earth pressures presented in **Table 2** are recommended for the design of retaining structures with a gravel backdrain and backfill soils of expansivity not higher than medium. Should the slope behind the retaining walls be other than level or 2:1 (H:V), supplemental design criteria will be provided for the active earth or at-rest pressures for the particular slope angle.

Table 2
 Lateral Earth Pressures

Type	Soil Profile	Soil Pressure (psf/ft)	
		Unrestrained Wall	Rigidly Supported Wall
Active Pressure	Level 2:1	35	-
		55	-
At-Rest Pressure	Level 2:1	-	70
		-	100
Passive Pressure* *Neglect upper 2'	Level 2:1	400	200
		200	100

- b. The friction factor between rough concrete and the native, near-surface **clayey sand** is **0.35**.
- c. Where both friction and the passive resistance are utilized for sliding resistance, either of the values indicated should be reduced by one-third.
- d. When required by the code, lateral load due to earthquakes may be calculated as $13xH^2$ acting at $0.6H$ above the base of the wall.
- e. These are ultimate values, no factor of safety has been applied.
- f. Although not anticipated, pressure due to any surcharge loads from adjacent footings, traffic, etc., should be analyzed separately.

5.5.3 Backfill

- a. Backfill should be placed under engineering control.
- b. The **wall backfill must be non-expansive native or import** for a width equal to approximately $1/3$ x wall height, and not less than 2 feet, subject to review during construction.

- c. The granular backfill should be capped with at least 12 inches of relatively impermeable material.
- d. Backfill should be compacted to achieve a minimum 90 percent relative compaction, the compaction standard being obtained in accordance with ASTM D-1557.
- e. Precautions should be taken to ensure that heavy compaction equipment is not used immediately adjacent to walls, so as to prevent undue pressures against, and movement of, the walls.
- f. The use of water-stops/impermeable barriers and appropriate waterproofing should be considered for any basement construction, and for building walls which retain earth.

5.5.4 Backfill Drainage

- a. Backdrains should consist of a minimum 4-inch diameter, perforated, SDR 35 pipe or equivalent, embedded in permeable material meeting the State of California Standard Specification Section 68-1.025, Class I or II, Type A, or equivalent. A layer of **Mirafi 140N Filter Fabric**, or equivalent, shall be placed over the permeable material and the remaining 12 inches shall be capped with compacted native soil. The pipe should be approximately 4 inches above the trench bottom with a gradient of at least 1% being provided to the pipe and trench bottom, discharging to an approved location. See **Figure 5** for Retaining Wall Backdrain Configuration.
- b. Perforations in backdrains are recommended as follows: 3/8-inch diameter, in 2 rows at the ends of a 120 degree arc, at 3-inch centers in each row, staggered between rows, placed downward.
- c. Backdrains placed behind retaining walls should be approved by the Geotechnical Consultant prior to the placement of backfill.
- d. An unobstructed outlet should be provided at the lower end of each segment of backdrain. The outlet should consist of an unperforated pipe of the same diameter, connected to the perforated pipe and extended to a protected outlet at a lower elevation on a continuous gradient of at least 1%.
- e. When terrace retaining walls are proposed, the upper retaining wall should have a backdrain which extends below the elevation of the top of the lower retaining wall backdrain. This will prevent spring effects and seepage between the terraced walls.

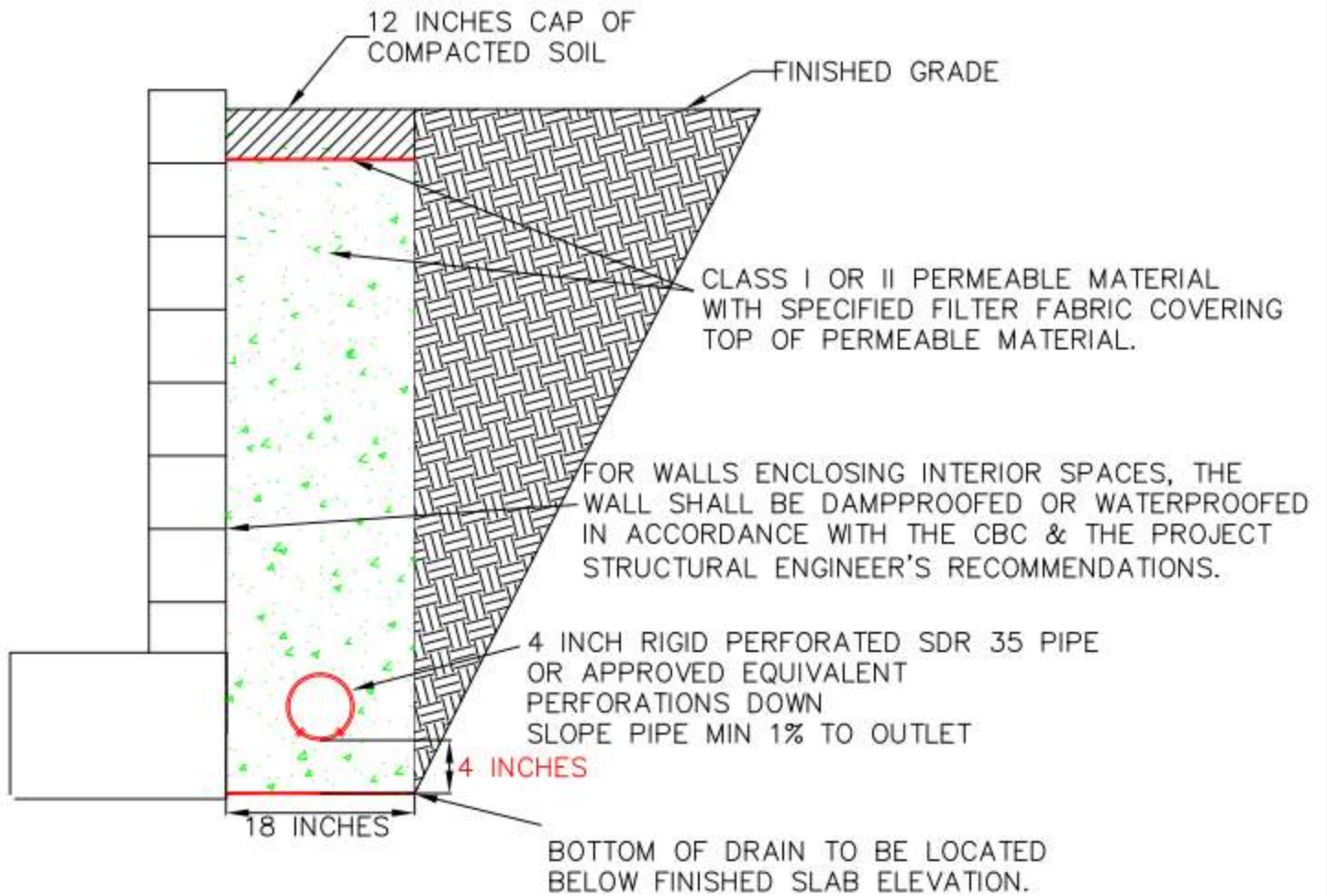

5.6 Pavement Design

The design of the pavement section was beyond our scope of services. The following considerations are imperative for the selected pavement sections to perform effectively:

- a. Use only quality materials of the type and minimum thickness specified. All baserock must meet Cal-Trans Standard Specifications for Class II Aggregate Base.
- b. The **R-Value should be obtained at the conclusion of grading** and the design pavement sections reviewed at that time.
- c. Compact the base and subgrade uniformly to a minimum relative dry density of 95%.
- d. Asphalt concrete should be placed only during periods of fair weather when the ambient air temperature is within prescribed limits.
- e. Provide sufficient gradient to prevent ponding of water.
- f. Maintenance should be undertaken on a routine basis.

5.7 Exterior Concrete Flatwork

- a. Concrete flatwork should be divided into as nearly square panels as possible. Frequent joints should be provided to give articulation to the panels. Landscaping and planters adjacent to concrete flatwork should be designed in such a manner as to direct drainage away from concrete areas to approved outlets.
- b. It is assumed that concrete flatwork will be subjected only to pedestrian traffic.

6. **LIMITATIONS**

- a. Our investigation was performed in accordance with the usual and current standards of the profession, as they relate to this and similar localities. No other warranty, expressed or implied, is provided as to the conclusions and professional advice presented in this report.
- b. The samples taken and tested, and the observations made, are considered to be representative of the site; however, soil and geologic conditions can vary significantly between sample locations.
- c. As in most projects, conditions revealed during construction excavation may be at variance with preliminary findings. If this occurs, the changed conditions must be evaluated by the Project Geotechnical Consultant and the Geologist, and revised recommendations be provided as required.
- d. This report is issued with the understanding that it is the responsibility of the Owner, or of his Representative, to ensure that the information and recommendations contained herein are brought to the attention of the Architect and Engineer for the project and incorporated into the plans, and that it is ensured that the Contractor and Subcontractors implement such recommendations in the field.
- e. This firm does not practice or consult in the field of safety engineering. We do not direct the Contractor's operations, and we are not responsible for other than our own personnel on the site; therefore, the safety of others is the responsibility of the Contractor. The Contractor should notify the Owner if he considers any of the recommended actions presented herein to be unsafe.
- f. The findings of this report are considered valid as of the present date. However, changes in the conditions of a site can occur with the passage of time, whether they be due to natural events or to human activities on this or adjacent sites. In addition, changes in applicable or appropriate codes and standards may occur, whether they result from legislation or the broadening of knowledge.
- g. Accordingly, this report may become invalidated wholly or partially by changes outside our control. Therefore, this report is subject to review and revision as changed conditions are identified.

REFERENCES

1. Brabb, E.E., 1989, Geologic Map of Santa Cruz County, California, U.S. Geological Survey Miscellaneous Investigations Series Map I-1905, Scale: 1:62,500.
2. California Building Standards Commission, July 2013, 2013 California Building Code, California Code of Regulations, Title 24, Part 2, Effective January 1, 2014.
3. Cooper-Clark and Associates, 1975, Preliminary Map of Landslide Deposits in Santa Cruz County, California, Santa Cruz County Planning Dept., Scale: 1:62,500.
4. Dupré, W.R., 1975, Geology and Liquefaction Potential of Quaternary Deposits in Santa Cruz County, California, U.S. Geological Survey Miscellaneous Field Studies Map MF-648, Scale: 1:62,500.
5. Easton Geology Inc., Geologic Investigation, Farhat Property, Trembley Lane, Watsonville, California, Santa Cruz County, APN 051-411-20. Easton Geology Job No. G15021, 9 December 2016.
6. Hall, N.T., Sarna-Wojcicki, A.M., and Dupré, W.R., 1974, Faults and their Potential Hazards in Santa Cruz County, California, U.S. Geological Survey Miscellaneous Field Studies Map MF-626, Scale: 1:62,500.
7. Lattanzio & Associates, Trembley Lane Subdivision, Watsonville, CA, Sheet A1, Dated 6-2-14.
8. Novo Tech Software Ltd., NovoCPT 3.14.2016.527, First Release 2009.
9. Roper Engineering, Tentative Map, Tract No. 1582, Lakeview Estates, Trembley Lane, Watsonville, California, APN 051-411-20, Job No. 14036, Sheet T1, Revised December 30, 2014.
10. Seed et al.(2003), Recent Advances In Soil Liquefaction Engineering: A Unified And Consistent Framework, Dated: April 30, 2003.
11. U.S. Geologic Survey, U.S. Seismic Design Maps, Site Updated June 12, 2014, Utilized August 11, 2014. <http://earthquake.usgs.gov/designmaps/us/application.php>

APPENDIX A

FIELD EXPLORATION AND LABORATORY TESTING PROGRAM

•	Field Exploration Procedures	Page A-1
•	Laboratory Testing Procedures	Page A-2
•	Boring Location Plan	Figure A-1
•	Key to Logs	Figure A-2
•	Logs of Exploratory Borings	Figures A-3 thru A-7
•	Logs of CPT Soundings	Figures A-8 thru A-13
•	Summary of Laboratory Test Results	Figure A-14
•	Direct Shear Test Results	Figures A-15 & A-16
•	Consolidation Test Results	Figures A-17 & A-18
•	Grain Size Distribution Test Results	Figures A-19 & A-20

FIELD EXPLORATION PROCEDURES

- A-1. Subsurface conditions were previously explored by drilling 5 borings to depths between 6.5 and 31.5 feet below existing grade. The borings were advanced with a truck mounted drill rig equipped with 4 inch solid stem augers.
- A-2. The site was further explored by advancing 6 CPT soundings to depths ranging from 30 to 50 feet below existing grade.
- A-3. The approximate locations of the borings and CPT soundings are shown on the Boring Location Plan, **Figure A-1**. The Key to Logs, **Figure A-2**, gives definitions of the terms used in the Logs of Exploratory Borings. The Logs of Exploratory Borings are presented in **Figures A-3 through A-7**. The CPT Logs are presented in **Figures A-8 through A-13**.
- A-4. Drilling of the borings and CPT soundings was observed by our Field Engineer who logged the soils and obtained bulk and relatively undisturbed samples for classification and laboratory testing. The soils were classified, based on field observations and laboratory testing, in accordance with Unified Soil Classification System.
- A-5. Relatively undisturbed soil samples were obtained by means of a drive sampler. The hammer weight and drop being 140 pounds and 30 inches, respectively. The number of "Blows/Foot" required to drive samplers are indicated on the logs.
- A-6. Exploratory borings were located in the field by measuring from know landmarks. The locations, as shown, are therefore within the accuracy of such a measurement.
- A-7. Groundwater was encountered at varying depths below existing grade during the course of our field exploration. The groundwater depths are indicated on the logs.

LABORATORY TESTING PROCEDURES

A-6. Classification

Soils were classified in accordance with the Unified Soil Classification System. Moisture content and in-situ density determinations were made from relatively undisturbed soil samples. The results are presented in the Logs of Exploratory Borings and in the Summary of Laboratory Test Results, **Figure A-14**.

A-7. Direct Shear

Direct shear strength tests were performed on representative samples of the on-site soils in accordance with laboratory test standard ASTM D 3080-98. Samples were relatively undisturbed, or remolded as specified. To simulate possible adverse field conditions, the samples were saturated prior to testing unless otherwise noted. A saturating device was used which permitted the samples to absorb moisture while preventing volume change. The direct shear test results are presented in **Figures A-15 and A-16**.

A-8. Consolidation

Consolidation tests were performed on representative, relatively undisturbed samples of the underlying soils to determine compressibility characteristics. The samples were saturated during the tests to simulate possible adverse field conditions. The test results are presented in **Figures A-17 and A-18**.

A-9. Expansion Index

Expansion tests were performed on representative, remolded samples of the on-site soils in accordance with laboratory test standard ASTM D 4829-95. The test results are presented in **Figure A-14**.

A-10. Amount of Materials in Soil Finer than the No. 200 Sieve

Determination of the amount of materials in the soil finer than the No. 200 sieve analyses was performed on samples considered representative of the on-site soils. The laboratory test was performed in accordance with ASTM: D 1140. The test results are presented in **Figure A-14**.

A-11. Soluble Sulfates

The soluble sulfate content was determined for samples considered representative of the on-soils likely to come in contact with concrete in accordance with test method California 417. The test results are presented in **Figure A-14**.

A-12. Particle Size Analysis

Particle size analyses were performed on samples considered representative of the on-site soils. The laboratory standard used was ASTM: D 422. The test results are presented in **Figures A-19 and A-20**.

KEY TO LOGS

UNIFIED SOIL CLASSIFICATION SYSTEM

PRIMARY DIVISIONS			GROUP SYMBOL	SECONDARY DIVISIONS
COARSE GRAINED SOILS More than half of the material is larger than the No. 200 sieve	GRAVELS More than half of the coarse fraction is larger than the No. 4 sieve	CLEAN GRAVELS (Less than 5% fines)	GW	Well graded gravels, gravel-sand mixtures, little or no fines
			GP	Poorly graded gravels, gravel-sand mixtures, little or no fines
		GRAVEL WITH FINES	GM	Silty gravels, gravel-sand-silt mixtures, non-plastic fines
			GC	Clayey gravels, gravel-sand-clay mixtures, plastic fines
	SANDS More than half of the coarse fraction is smaller than the No. 4 sieve	CLEAN SANDS (Less than 5% fines)	SW	Well graded sands, gravelly sands, little or no fines
			SP	Poorly graded sands, gravelly sands, little or no fines
		SAND WITH FINES	SM	Silty sands, sand-silt mixtures, non-plastic fines
			SC	Clayey sands, sand-clay mixtures, plastic fines
FINE GRAINED SOILS More than half of the material is smaller than the No. 200 sieve	SILTS AND CLAYS Liquid limit less than 50	ML	Inorganic silts and very fine sands, silty or clayey fine sands or clayey silts with slight plasticity	
		CL	Inorganic clays of low to medium plasticity, gravelly clays, sandy clays, silty clays, lean clays	
		OL	Organic silts and organic silty clays of low plasticity	
	SILTS AND CLAYS Liquid limit greater than 50	MH	Inorganic silts, micaceous or diatomaceous fine sandy or silty soils, elastic silts	
		CH	Inorganic clays of high plasticity, fat clays	
		OH	Organic clays of medium to high plasticity, organic silts	
HIGHLY ORGANIC SOILS			Pt	Peat and other highly organic soils

GRAIN SIZE LIMITS

SILT AND CLAY	SAND			GRAVEL		COBBLES	BOULDERS
	FINE	MEDIUM	COARSE	FINE	COARSE		
	No. 200	No. 40	No. 10	No. 4	3/4 in.	3 in.	12 in.
US STANDARD SIEVE SIZE							

RELATIVE DENSITY	
SAND AND GRAVEL	BLOWS/FT*
VERY LOOSE	0 - 4
LOOSE	4 - 10
MEDIUM DENSE	10 - 30
DENSE	30 - 50
VERY DENSE	OVER 50

CONSISTENCY	
SILT AND CLAY	BLOWS/FT*
VERY SOFT	0 - 2
SOFT	2 - 4
FIRM	4 - 8
STIFF	8 - 16
VERY STIFF	16 - 32
HARD	OVER 32

MOISTURE CONDITION
DRY
DAMP
MOIST
WET

* Number of blows of 140 pound hammer falling 30 inches to drive a 2 inch O.D. (1 3/8 inch I.D.) split spoon (ASTM D-1586).

LOG OF EXPLORATORY BORING

Project No.: 14034	Boring: B1	
Project: Trembley Lane Watsonville, California	Location: Northwest Side of Lot Between Lots 8 & 9	Elevation: ~124'
Date: July 3, 2014	Method of Drilling: Truck Mounted Drill Rig, 4in. Solid Stem Auger, 140lb. Safety Hammer	
Logged By: DO		

Depth (ft.)	Soil Type	Undisturbed	Bulk	<div style="display: flex; justify-content: space-around; font-size: small;"> <div style="border: 1px solid black; width: 15px; height: 15px; transform: rotate(45deg); margin: 2px;"></div> 2" DIA Sample</div> <div style="border: 1px solid black; width: 15px; height: 15px; transform: rotate(-45deg); margin: 2px;"></div> 2.5" DIA Sample
-------------	-----------	-------------	------	--

LOG OF EXPLORATORY BORING

Project No.: 14034	Boring: BI Continued	
Project: Trembley Lane Watsonville, California	Location: Northwest Side of Lot Between Lots 8 & 9	
Date: July 3, 2014	Elevation:	
Logged By: DO	Method of Drilling: Truck Mounted Drill Rig, 4in. Solid Stem Auger, 140lb. Safety Hammer	

Depth (ft.)	Soil Type	Undisturbed	Bulk	<input checked="" type="checkbox"/> 2" DIA Sample <input type="checkbox"/> 2.5" DIA Sample <input checked="" type="checkbox"/> Bulk Sample	Blows	Dry Density (pcf)	Moisture Content (%)	Wet Density (pcf)	Direct Shear		Miscellaneous Laboratory Testing
				<input type="checkbox"/> Terzaghi Split Spoon Sample <input type="checkbox"/> Static Water Table					c (psf)	φ °	
	SM/SC		<input checked="" type="checkbox"/>	Blue Grey/Green Silt to Very Fine Grained SAND. Moist Blue Grey/Green SAND. Moist, Medium Dense, Non-Plastic. Water on Outside of Sampler.	17		27.8				
30			<input checked="" type="checkbox"/>	Grey Blue SAND. Saturated, Non-Plastic. Grey Blue Fat SILT. Wet, Plastic. Grey Blue SAND. Saturated, Non-Plastic.	14		36.0				
35				Boring Terminated @ 31.5 ft. Perched Groundwater Encountered at 19.5 and 23 ft. Groundwater Measured at 17.5 ft After Drilling, Collapsed to 19.5 ft Boring Backfilled With Cuttings.							
40											
45											
50											

LOG OF EXPLORATORY BORING

Project No.: 14034	Boring: B2	
Project: Trembley Lane Watsonville, California	Location: Center of Parcel	
Date: July 3, 2014	Elevation: ~118'	
Logged By: DO	Method of Drilling: Truck Mounted Drill Rig, 4in. Solid Stem Auger, 140lb. Safety Hammer	

Depth (ft.)	Soil Type	Undisturbed	Bulk	Description	Blows	Dry Density (pcf)	Moisture Content (%)	Wet Density (pcf)	Direct Shear		Miscellaneous Laboratory Testing
									c (psf)	φ °	
				Brown SILT with SAND. Dry, Medium Plastic.							
	SC			Brown Clayey SAND with Gravel. Dry, Medium Dense, Plastic. Medium to Coarse Grained Sand.	49	109.6	9.3	119.8			Consolidation
				Material Consistent. Gravelly.	22		8.5				
5				Light Brown Sand with Clay and Gravel. Dry, Non-Plastic.		111.0	8.5	120.4			
	ML			Light Brown with Oxide Staining SILT. Moist, Stiff, Non-Plastic.	15		24.7				
							24.1				
	SC			Brown Clayey SAND. Moist, Loose, Non-Plastic.	10		17.5				
10											
	SM/SC			Red Brown/Black Sand with Fines. Moist, Non-Plastic. Over Light Brown Clayey Sand Over Poorly Graded Sand With Fines, Over Light Brown Clayey SAND Over Red Fine Grained Sand, Over Tan Silt (Plastic). Moist, Loose, Non-Plastic.	16	105.9	15.1	121.9			
					8		31.4				
15				Boring Terminated 13 ft. Groundwater Not Encountered. Boring Backfilled With Cuttings.							
20											
25											

LOG OF EXPLORATORY BORING

Project No.: 14034	Boring: B3	
Project: Trembley Lane Watsonville, California	Location: Southeast Lower Corner of Parcel, Lot 4/5	
Date: July 3, 2014	Elevation: ~101'	
Logged By: DO	Method of Drilling: Truck Mounted Drill Rig, 4in. Solid Stem Auger, 140lb. Safety Hammer	

Depth (ft.)	Soil Type	Undisturbed	Bulk	<div style="display: flex; justify-content: space-around; font-size: small;"> <div style="border: 1px solid black; width: 15px; height: 15px; transform: rotate(45deg); margin: 2px;"></div> 2" DIA Sample</div> <div style="border: 1px solid black; width: 15px; height: 15px; transform: rotate(-45deg); margin: 2px;"></div> 2.5" DIA Sample
-------------	-----------	-------------	------	--

Boring Terminated @ 21.5 ft.
Perched Groundwater Encountered at 6, 11, 15 and 20 ft.
Groundwater Measured at 5.25 ft After Drilling,
Collapse to 6.75 ft
Boring Backfilled With Cuttings.

LOG OF EXPLORATORY BORING

Project No.: 14034	Boring: B4	
Project: Trembley Lane Watsonville, California	Location: Southwest Corner of Parcel	
Date: July 3, 2014	Elevation: ~120'	
Logged By: DO	Method of Drilling: Truck Mounted Drill Rig, 4in. Solid Stem Auger, 140lb. Safety Hammer	

Depth (ft.)	Soil Type	Undisturbed	Bulk	<div style="display: flex; justify-content: space-around; font-size: small;"> <div style="border: 1px solid black; width: 15px; height: 15px; transform: rotate(45deg); margin: 2px;"></div> 2" DIA Sample</div> <div style="border: 1px solid black; width: 15px; height: 15px; transform: rotate(-45deg); margin: 2px;"></div> 2.5" DIA Sample
-------------	-----------	-------------	------	--

Boring Terminated @ 16.5 ft.
Groundwater Not Encountered.
Boring Backfilled With Cuttings.

LOG OF EXPLORATORY BORING

Project No.: 14034	Boring: B5	
Project: Trembley Lane Watsonville, California	Location: Northwest Corner of Parcel	
Date: July 3, 2014	Elevation: ~128'	
Logged By: DO	Method of Drilling: Truck Mounted Drill Rig, 4in. Solid Stem Auger, 140lb. Safety Hammer	

Depth (ft.)	Soil Type	Undisturbed	Bulk	<div style="display: flex; justify-content: space-around; align-items: flex-start;"> <div style="text-align: center;"> <input checked="" type="checkbox"/> 2" DIA Sample <input type="checkbox"/> Terzaghi Split Spoon Sample </div> <div style="text-align: center;"> <input type="checkbox"/> 2.5" DIA Sample <input type="checkbox"/> Static Water Table </div> <div style="text-align: center;"> <input checked="" type="checkbox"/> Bulk Sample </div> </div>	Blows	Dry Density (pcf)	Moisture Content (%)	Wet Density (pcf)	Direct Shear		Miscellaneous Laboratory Testing
									c (psf)	φ °	
				Description							
				Brown SILT. Dry, Medium Plastic.							
	SC	<input checked="" type="checkbox"/>	<input checked="" type="checkbox"/>	Brown Clayey SAND with Gravel. Dry, Medium Dense, Plastic. Medium to Coarse Grained Sand.	40	112.9	9.5	123.7			#200 Wash
		<input type="checkbox"/>	<input type="checkbox"/>	Material Consistent.	30		11.0				
5		<input type="checkbox"/>	<input type="checkbox"/>	Material Consistent.							
	CL	<input checked="" type="checkbox"/>	<input checked="" type="checkbox"/>	Light Brown CLAY. Moist, Very Stiff, Plastic.	25	114.7	14.6	131.5			
	SC	<input checked="" type="checkbox"/>	<input checked="" type="checkbox"/>	Material Consistent. Grades to Clayey SAND. Moist, Medium Plastic.	10		19.8				
10				Boring Terminated @ 8 ft. Groundwater Not Encountered. Boring Backfilled With Cuttings.							
15											
20											
25											

Project No: 14034

Project: Trembley Lane Subdivision

Date: February 18, 2015

Borehole No: CPT-1

Groundwater Level: 5 Feet

Cone Area Ratio: 0.8

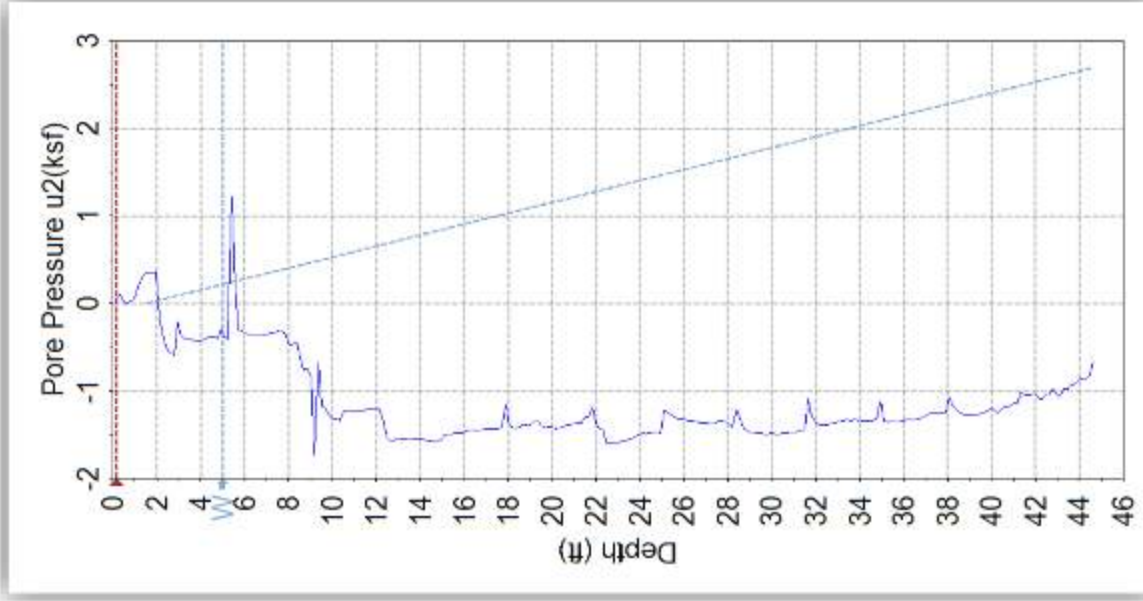
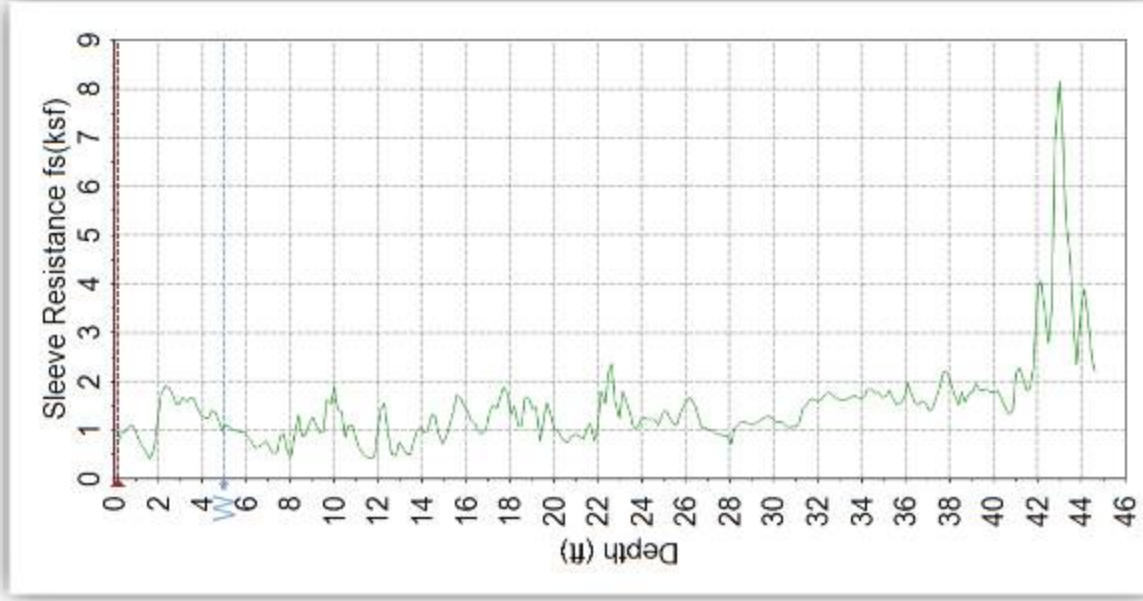
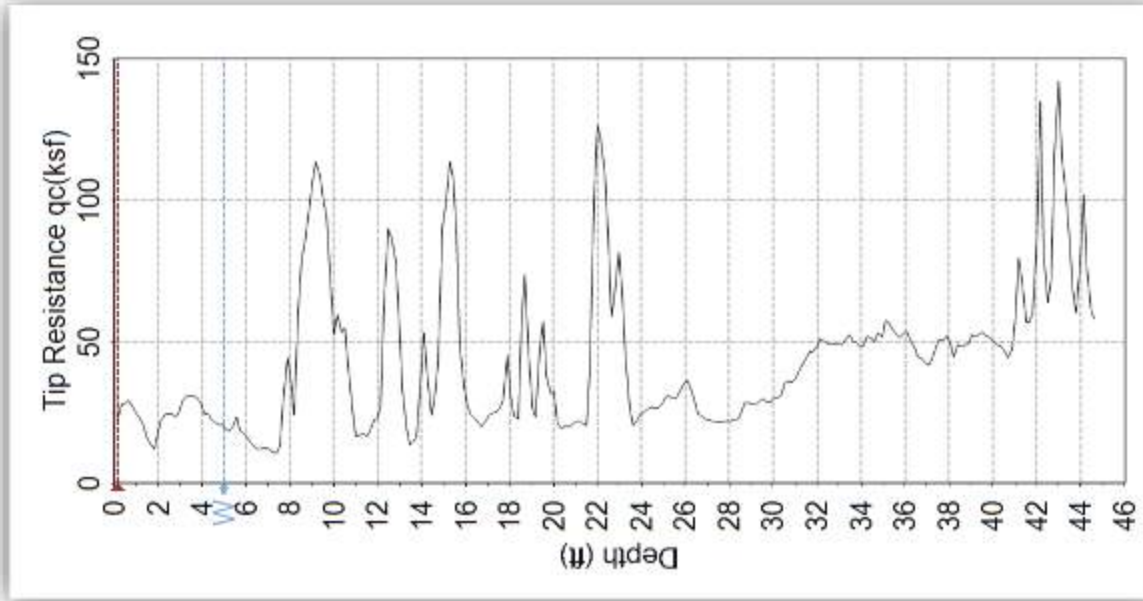

Project No: 14034

Project: Trembley Lane Subdivision

Date: February 18, 2015

Borehole No: CPT-1

Groundwater Level: 5 Feet

Cone Area Ratio: 0.8

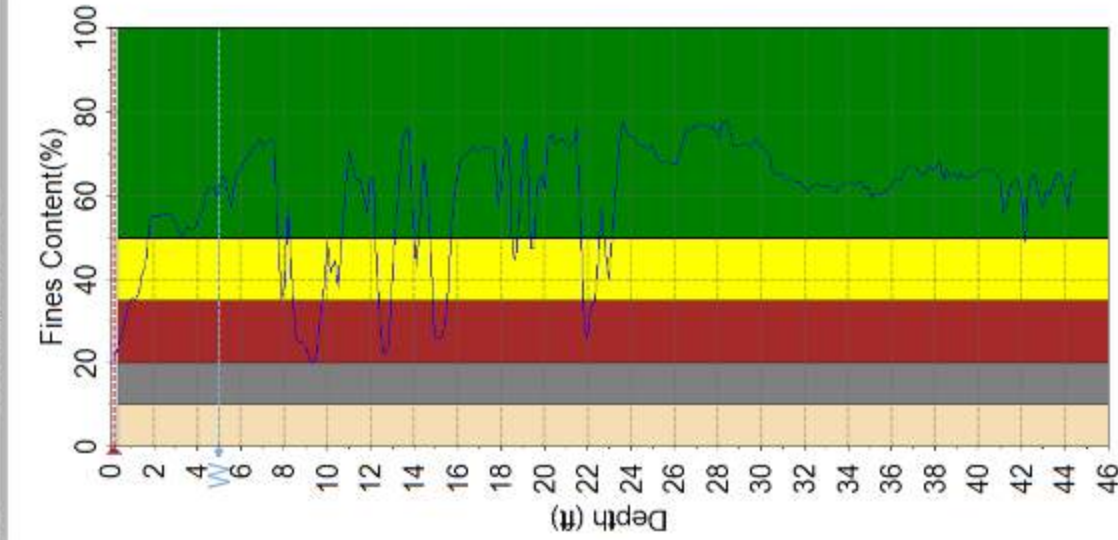

Fc = 42.4179 to 54.0574

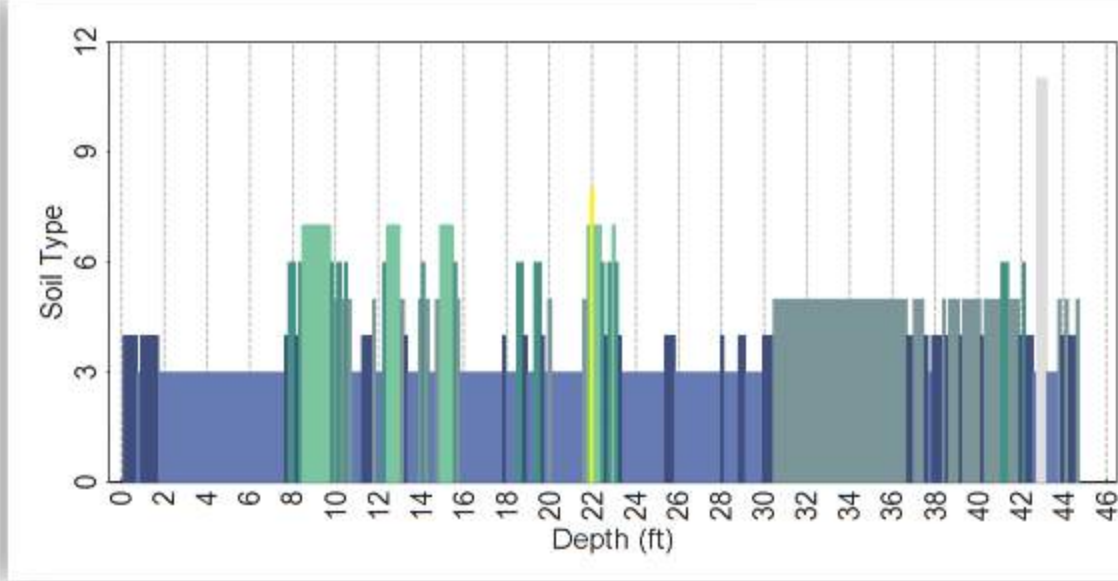

Robertson 1986 (SPT)

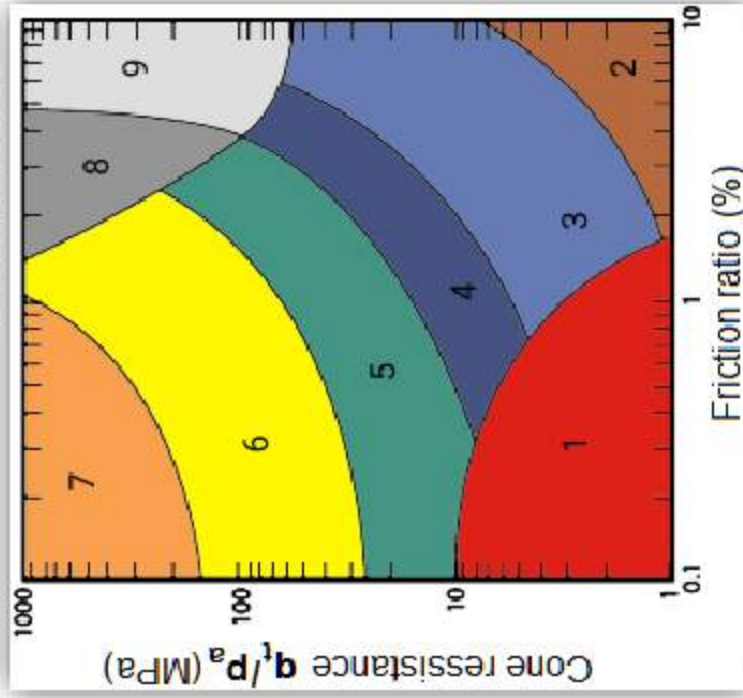

- 1. Sensitive Fines
- 2. Organic Material
- 3. Clay
- 4. Silty Clay to Clay
- 5. Clayey Silt to Silty Clay
- 6. Sandy Silt to Clayey Silt
- 7. Silty Sand to Sandy Silt
- 8. Gravelly Sand to Sand
- 9. Sand and silty sand
- 10. Very Stiff Fine-Grained
- 11. Sand
- 12. Sand to Clayey Sand

CPT LOGS

Trembley Lane, Watsonville

FIGURE

A-8.2



Project No: 14034

Project: Trembley Lane Subdivision

Date: February 18, 2015

Borehole No: CPT-2

Groundwater Level: 7 Feet

Cone Area Ratio: 0.8

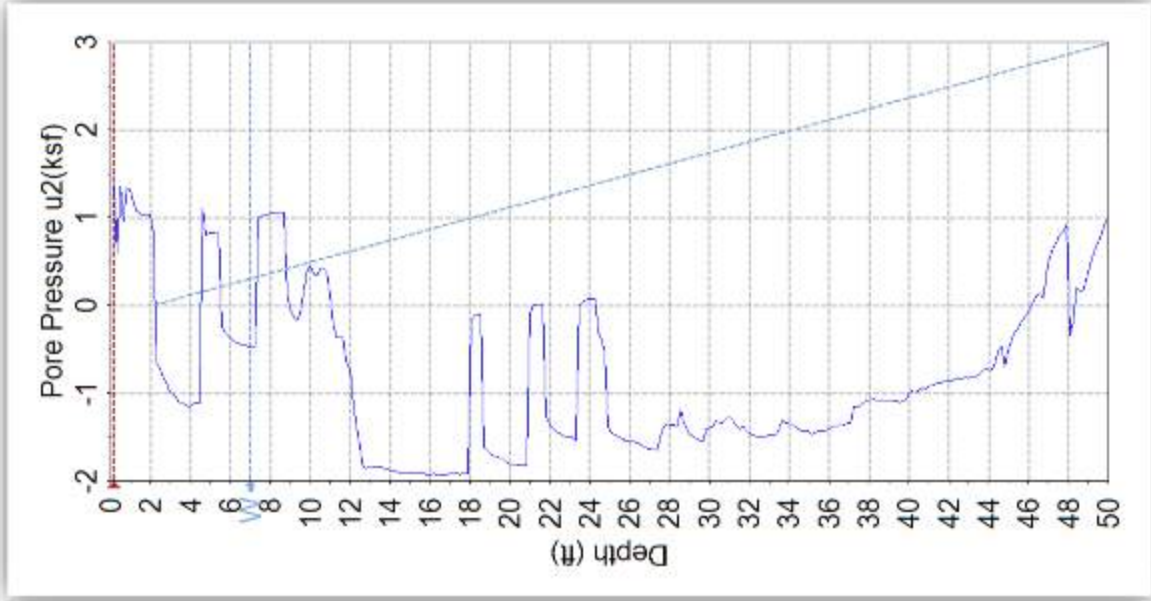
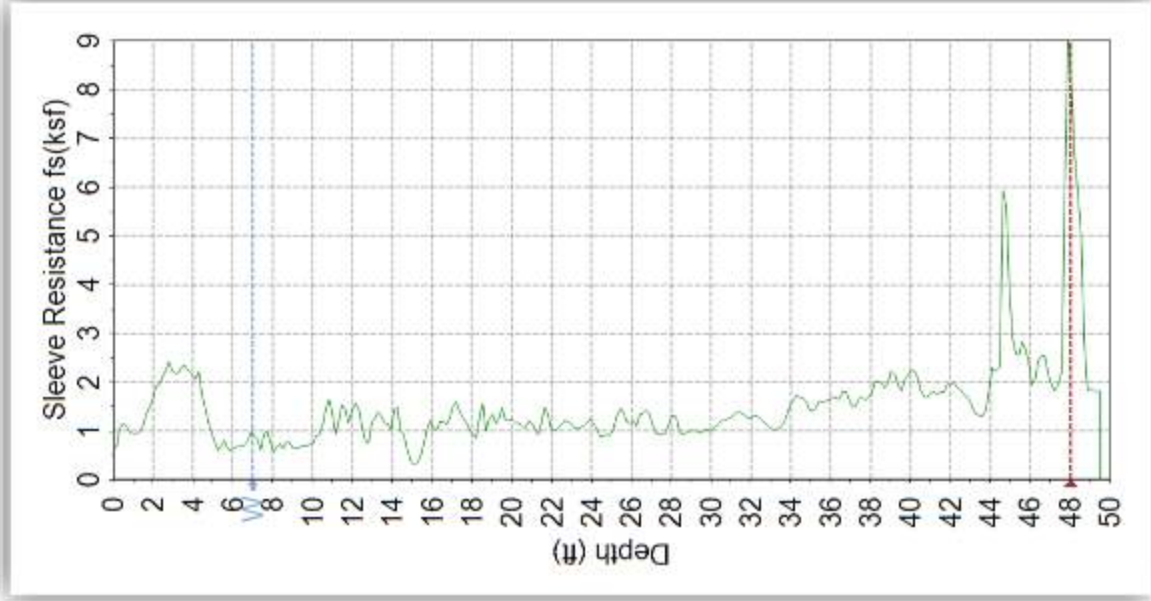
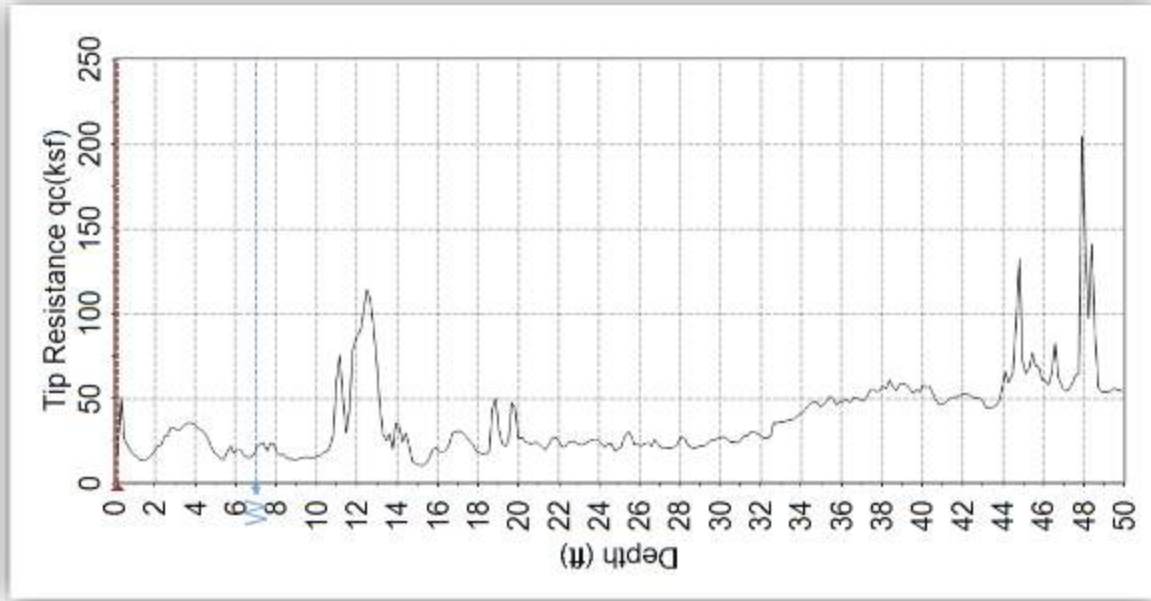

Project No: 14034

Project: Trembley Lane Subdivision

Date: February 18, 2015

Borehole No: CPT-2

Groundwater Level: 7 Feet

Cone Area Ratio: 0.8

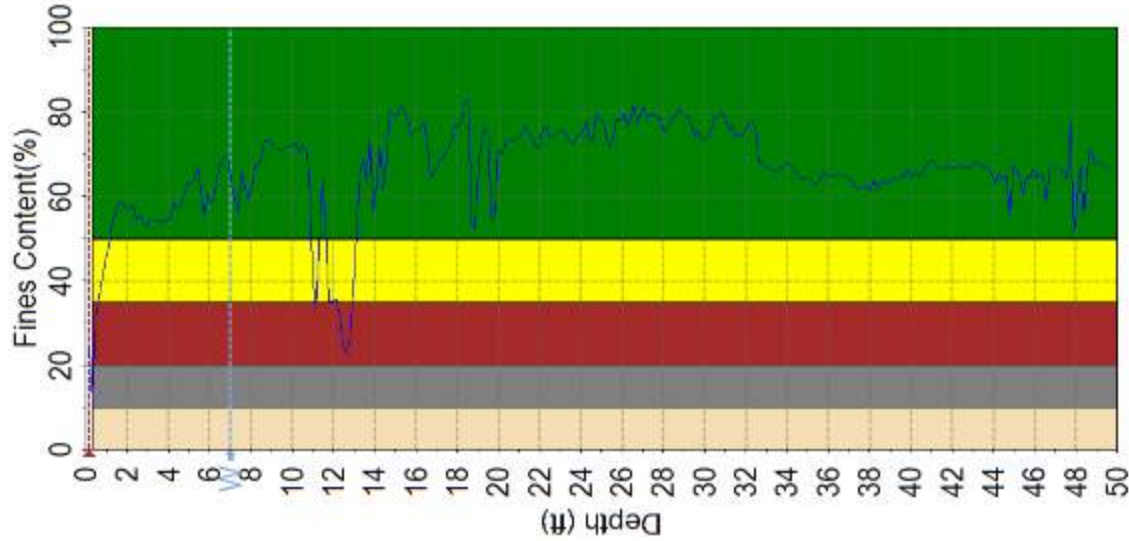

FC = 42.41% (CPT-2)

Robertson 1986 (SB7)

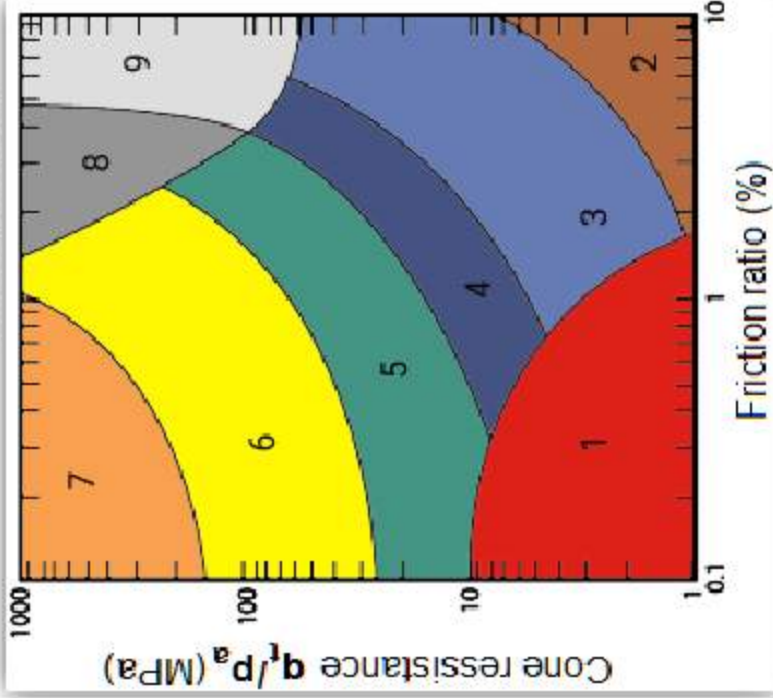
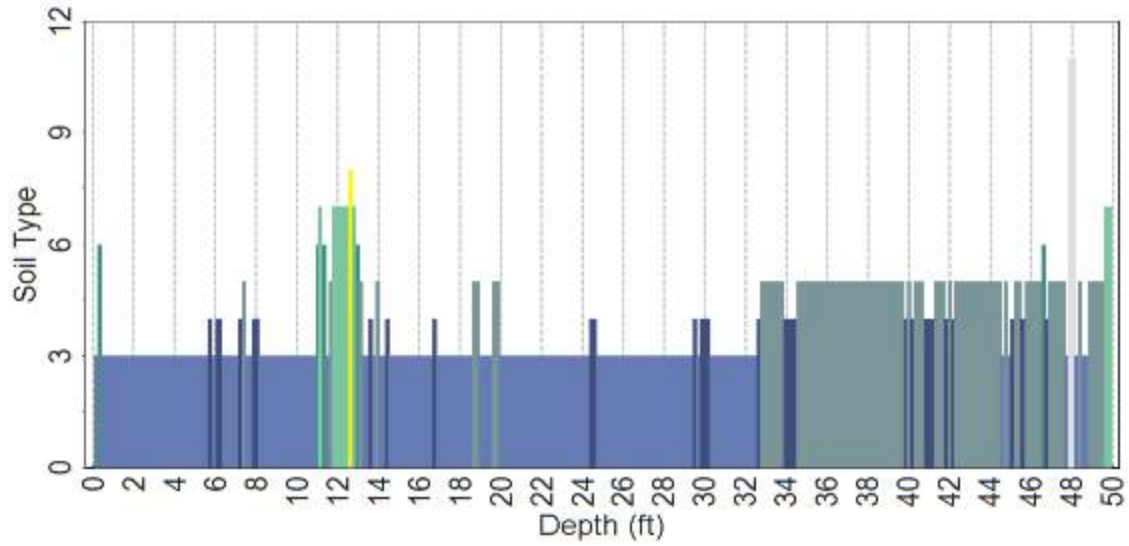

- 1. Sensitive Fines
- 2. Organic Material
- 3. Clay
- 4. Silty Clay to Clay
- 5. Clayey Silt to Silty Clay
- 6. Sandy Silt to Clayey Silt
- 7. Silty Sand to Sandy Silt
- 8. Gravelly Sand to Sand
- 9. Sand and Silty Sand
- 10. Very Stiff Fine-Grained
- 11. Sand to Clayey Sand
- 12. Sand

CPT LOGS

FIGURE

Trembley Lane, Watsonville

A-9.2

Project No: 14034

Project: Trembley Lane Subdivision

Date: February 18, 2015

Borehole No: CPT-3

Groundwater Level: 16 Feet

Cone Area Ratio: 0.8

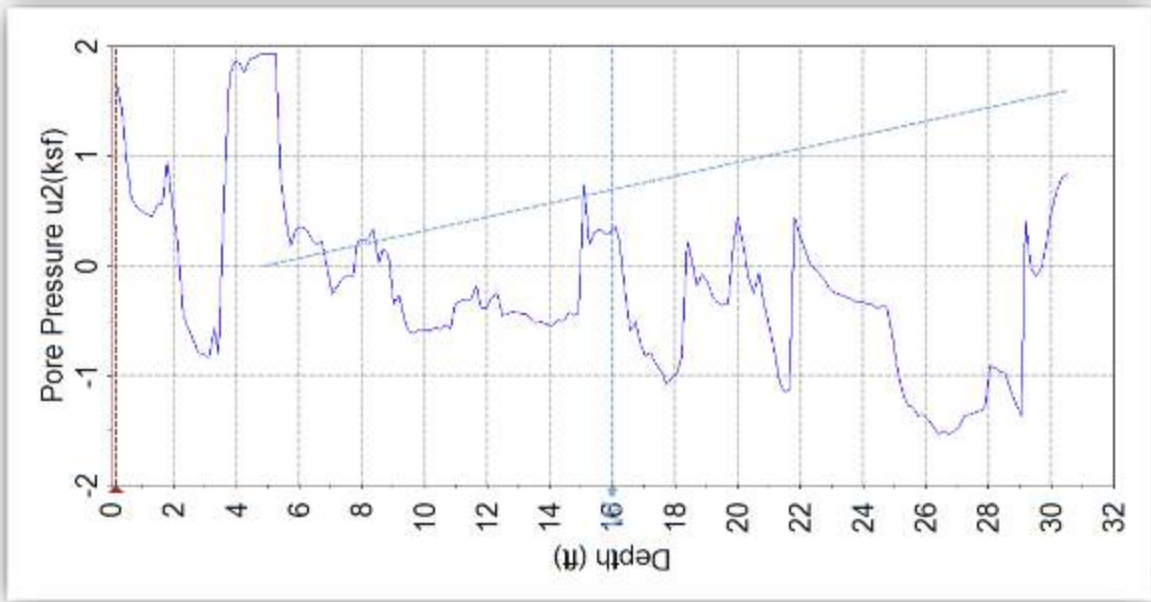
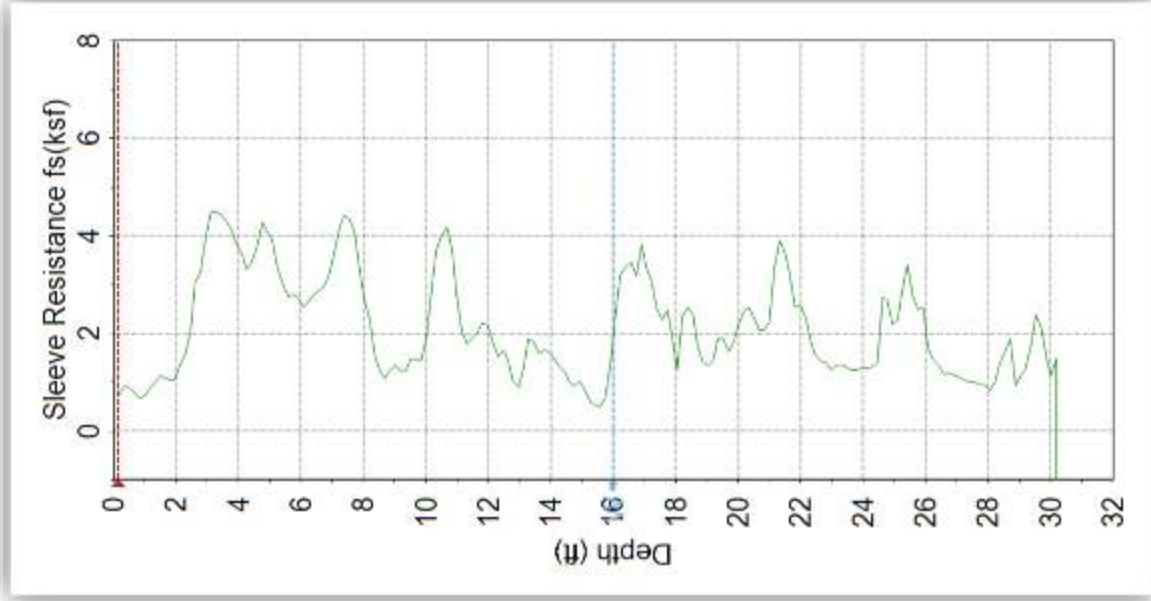
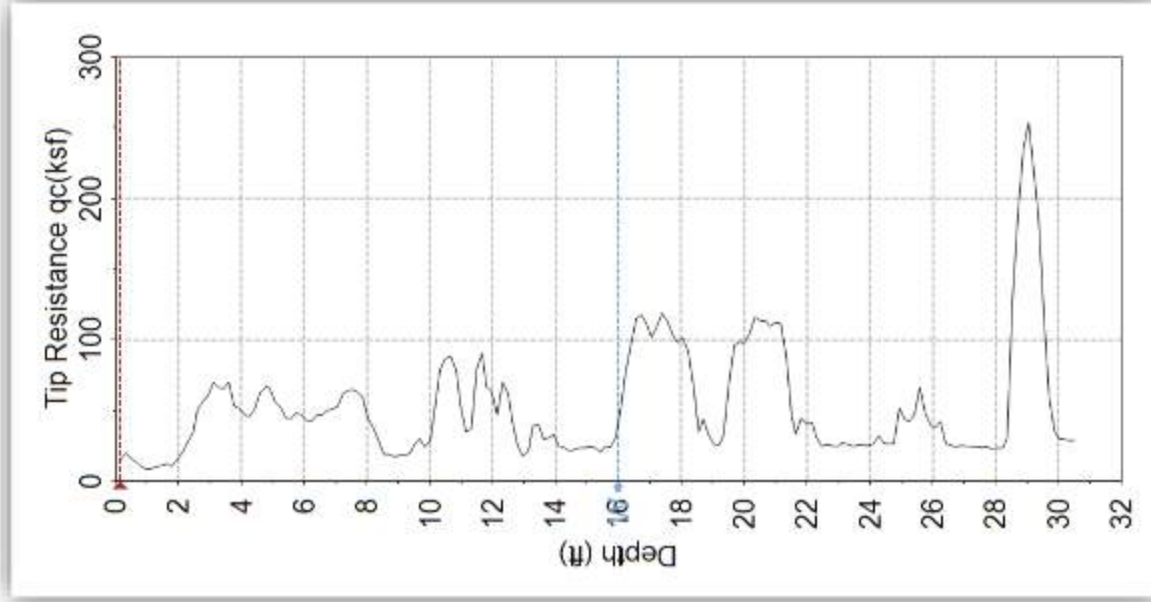

Project No: 14034

Project: Trembley Lane Subdivision

Date: February 18, 2015

Borehole No: CPT-3

Groundwater Level: 16 Feet

Cone Area Ratio: 0.8

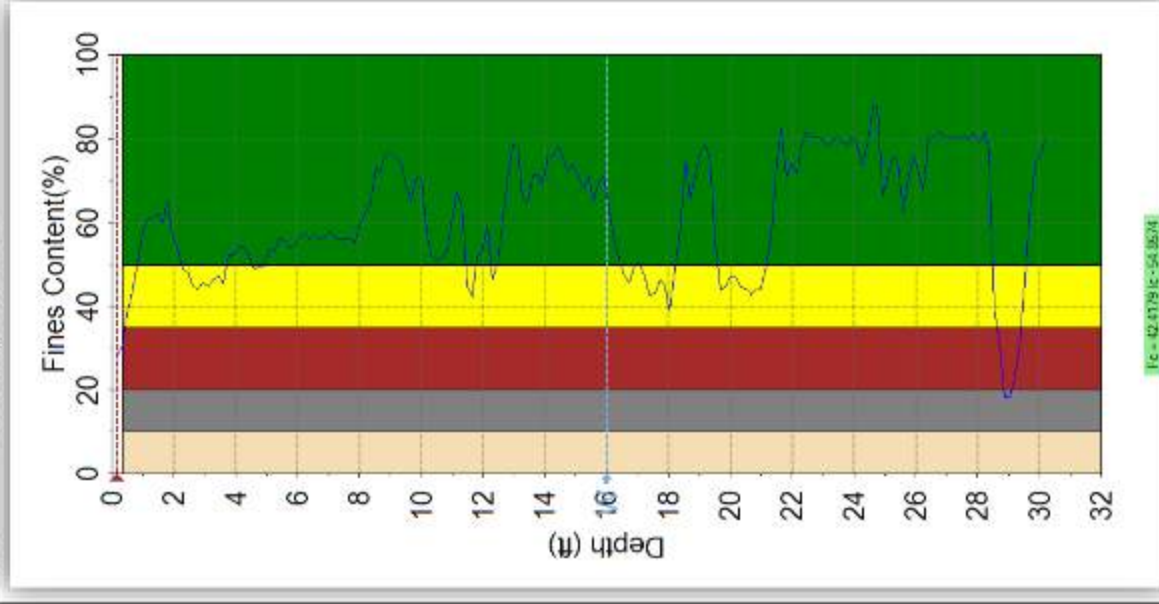
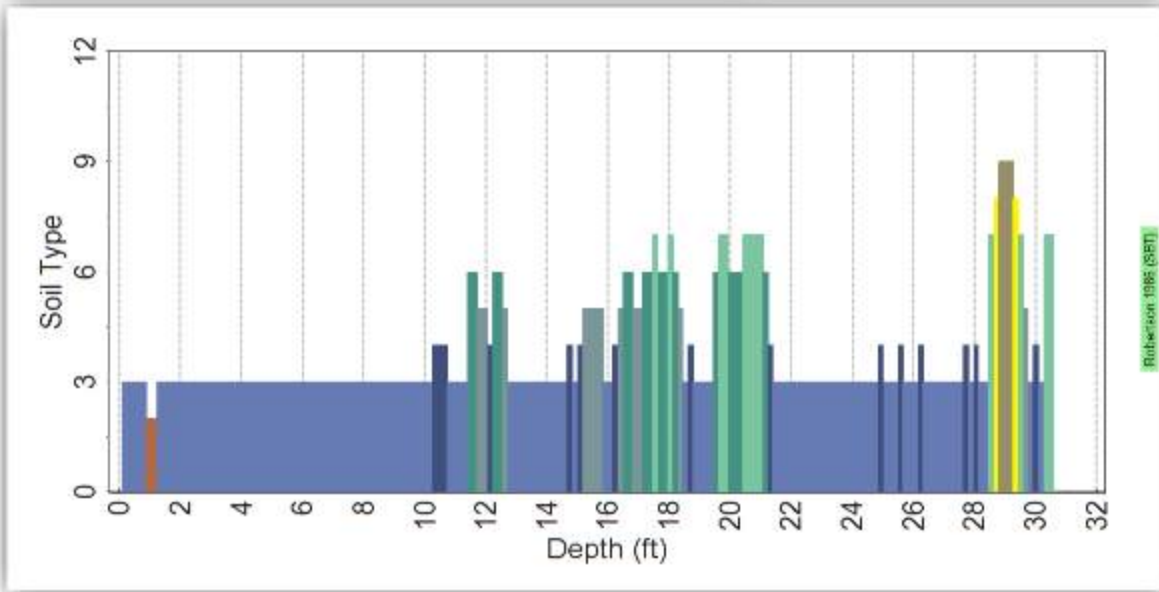
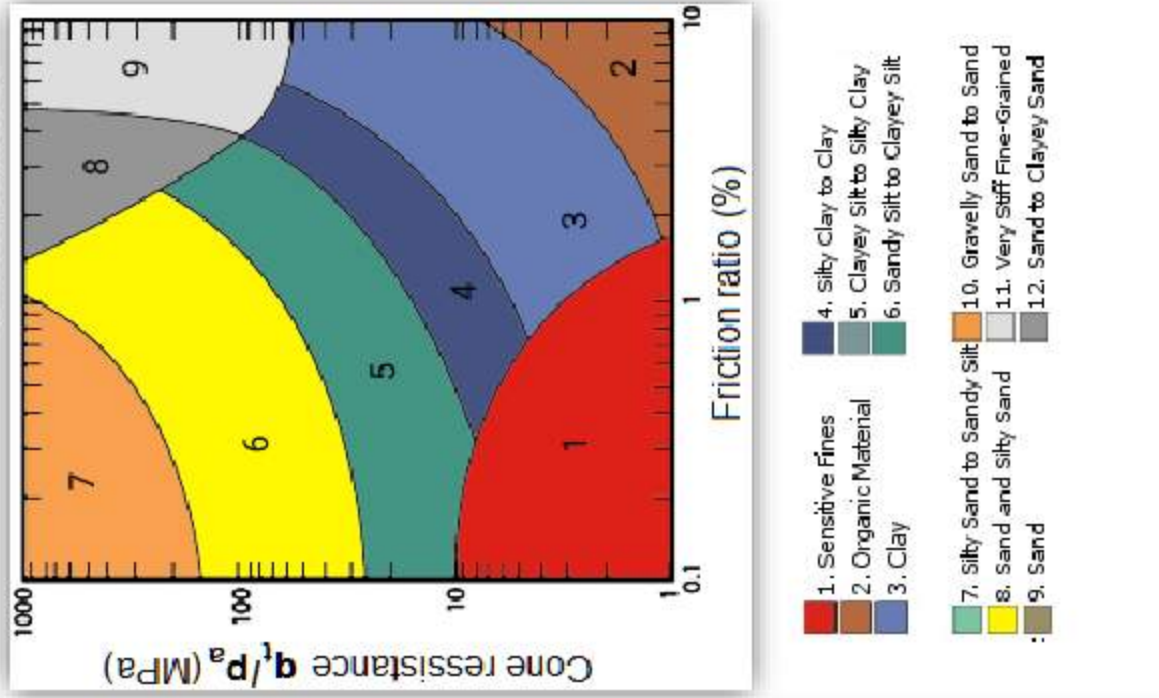

Fig. - 02.07.15 (C-54.0574)



Robinson 1985 (BET)



CPT LOGS

Trembley Lane, Watsonville

FIGURE

A-10.2



Project No: 14034

Project: Trembley Lane Subdivision

Date: February 18, 2015

Borehole No: CPT-4

Groundwater Level: 13 Feet

Cone Area Ratio: 0.8

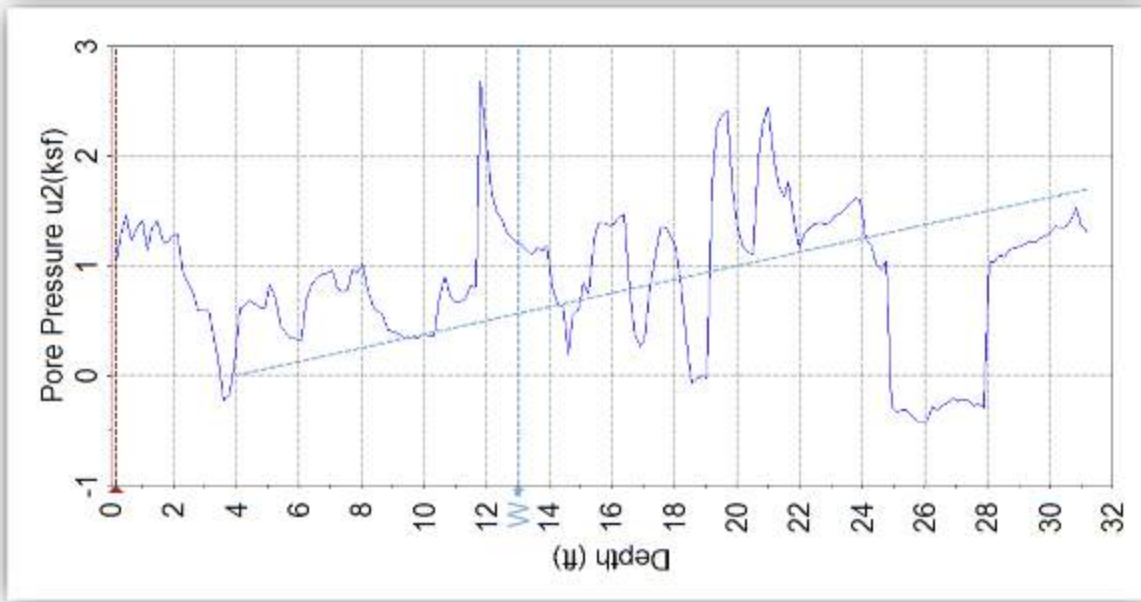
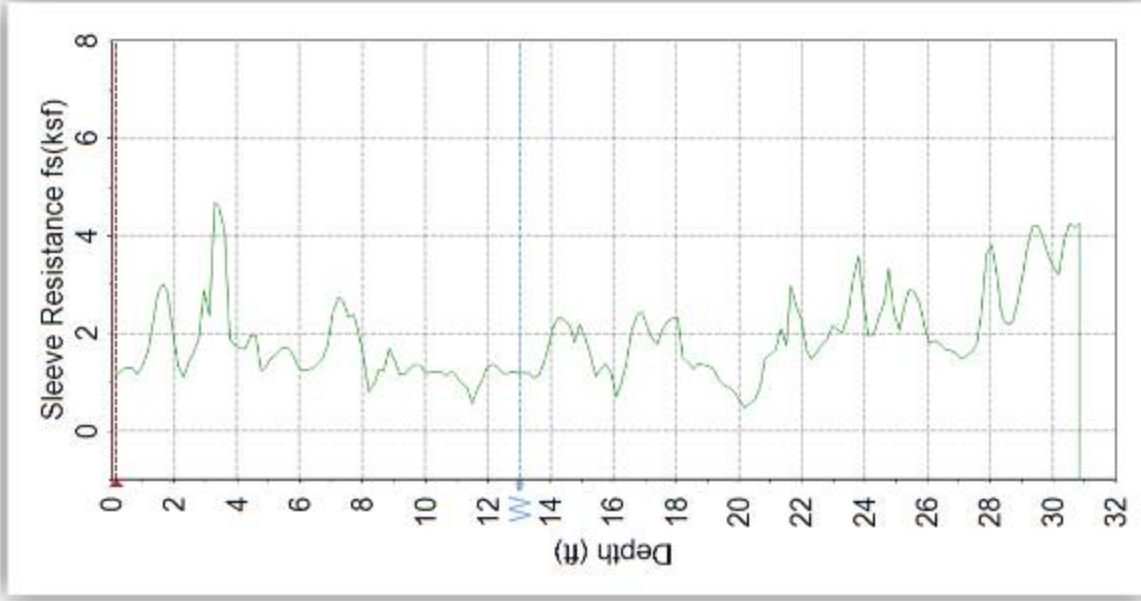
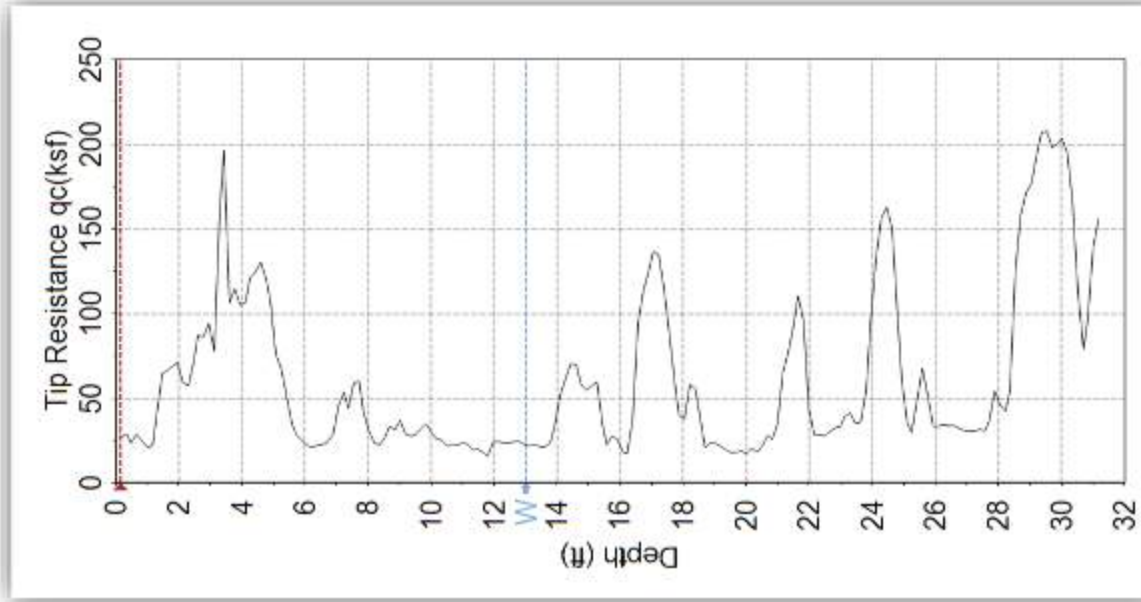

Project No: 14034

Project: Trembley Lane Subdivision

Date: February 18, 2015

Borehole No: CPT-4

Groundwater Level: 13 Feet

Cone Area Ratio: 0.8

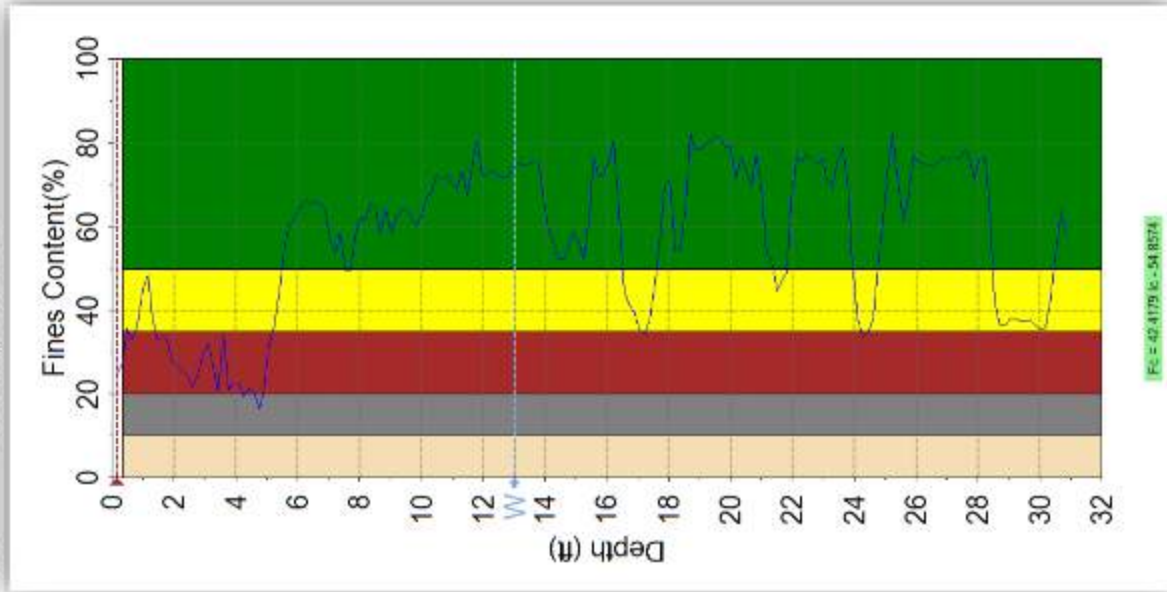

ES-42-4179 (S-5) (8/7/14)

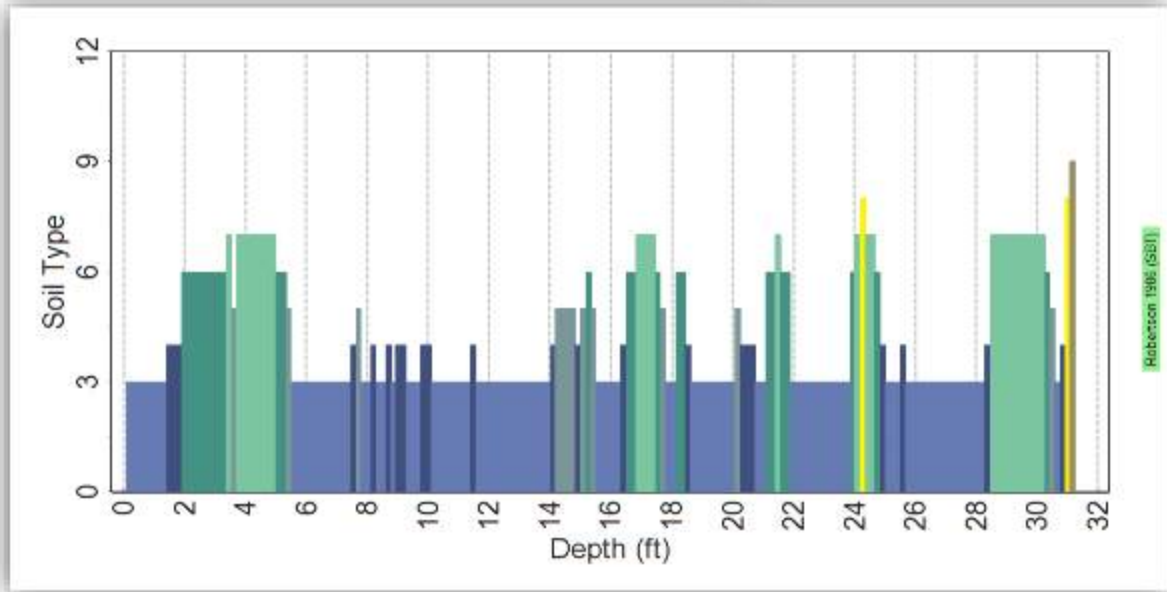

Robertson 1986 (S81)

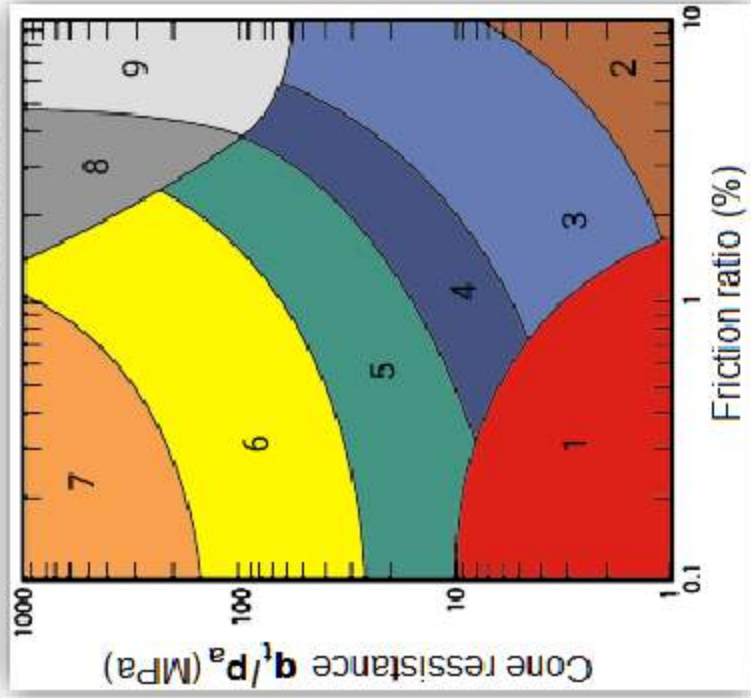

- 1. Sensitive Fines
- 2. Organic Material
- 3. Clay
- 4. Silty Clay to Clay
- 5. Clayey Silt to Silty Clay
- 6. Sandy Silt to Clayey Silt
- 7. Silty Sand to Sandy Silt
- 8. Sand and silty Sand
- 9. Sand
- 10. Gravelly Sand to Sand
- 11. Very Stiff Fine-Grained
- 12. Sand to Clayey Sand



CPT LOGS

Trembley Lane, Watsonville

FIGURE

A-11.2

Project No: 14034

Project: Trembley Lane Subdivision

Date: February 18, 2015

Borehole No: CPT-5

Groundwater Level: 13 Feet

Cone Area Ratio: 0.8

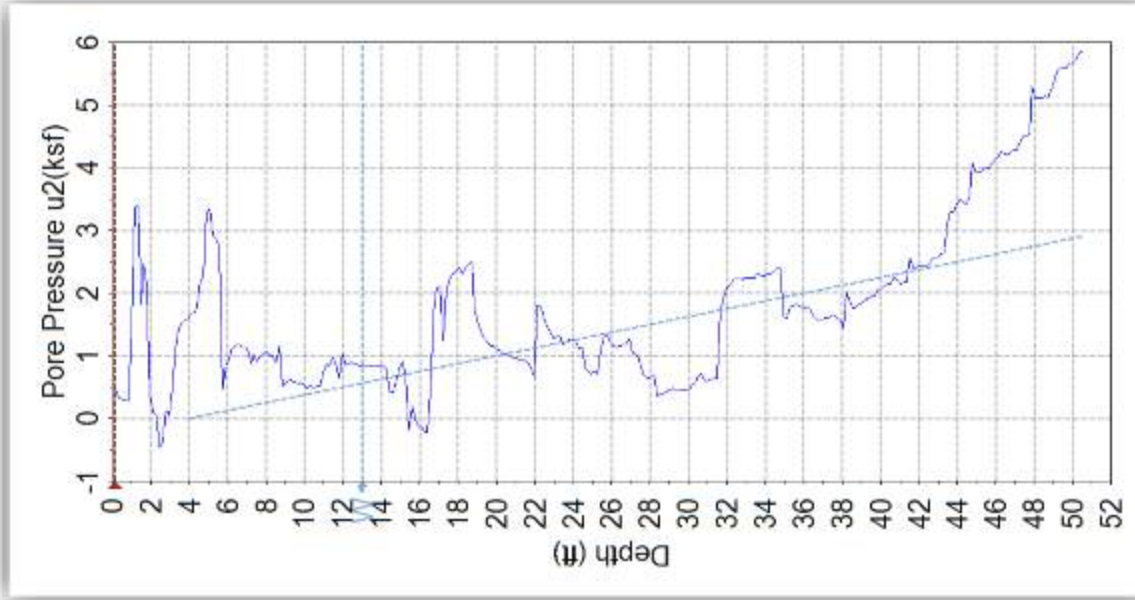
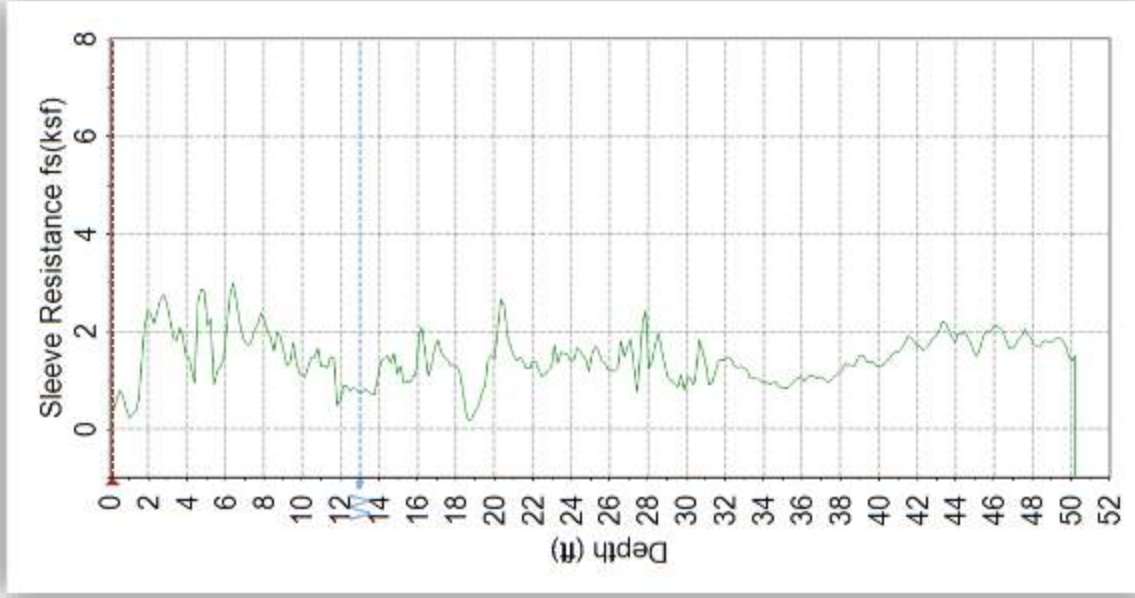
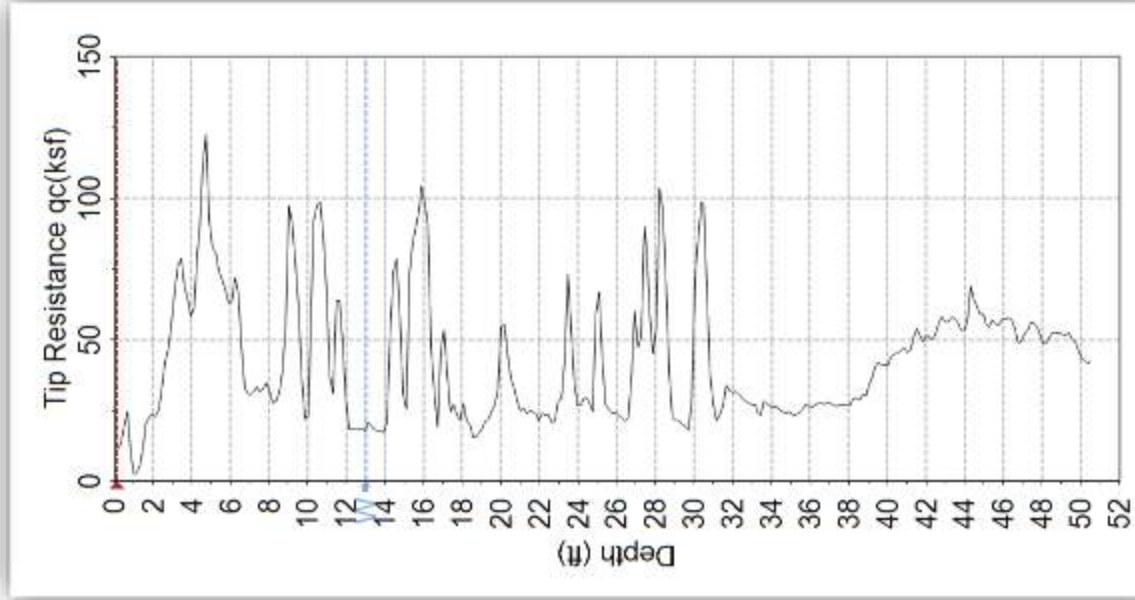

Project No: 14034

Project: Trembley Lane Subdivision

Date: February 18, 2015

Borehole No: CPT-5

Groundwater Level: 13 Feet

Cone Area Ratio: 0.8

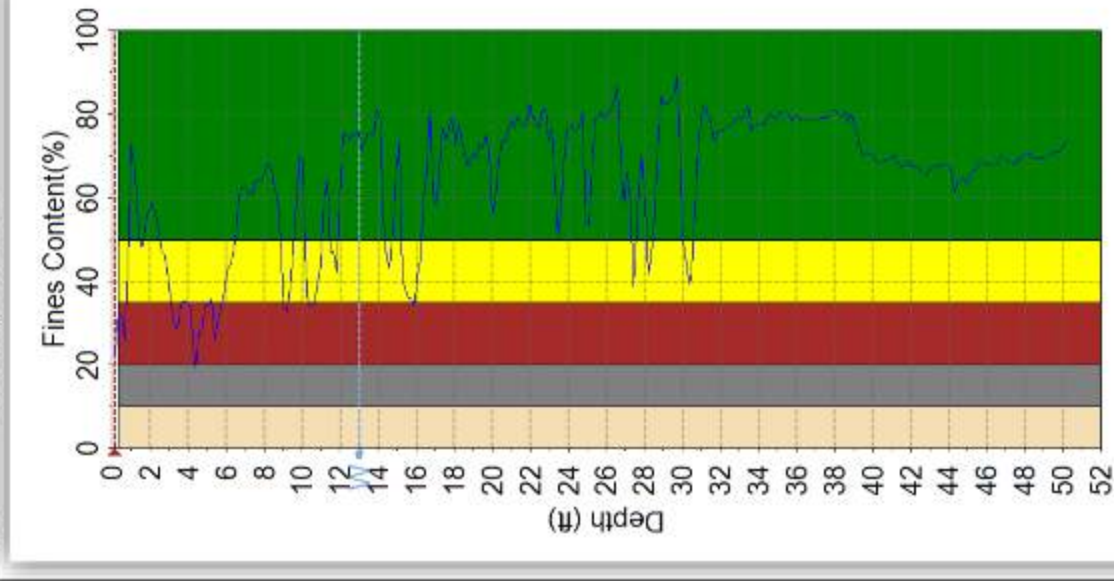

EC = 42.4179 k - 54.6574

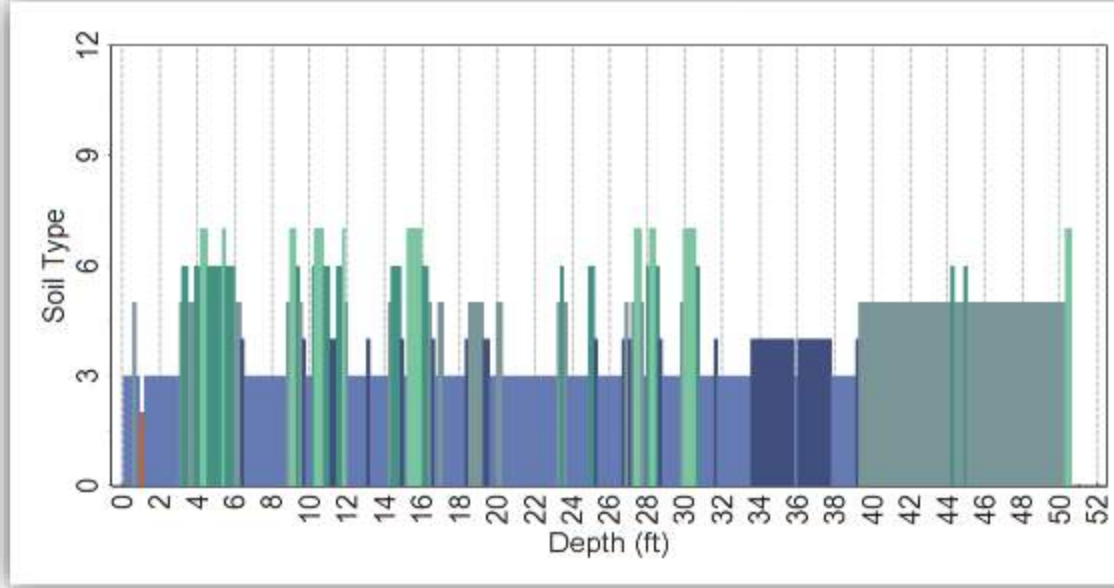

Robertson 1986 (S&S)

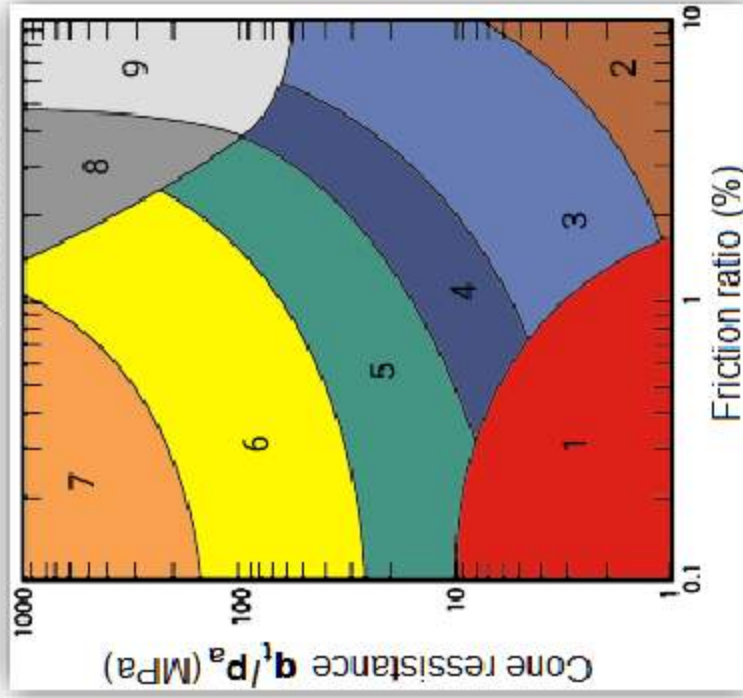

- 1. Sensitive Fines
- 2. Organic Material
- 3. Clay
- 4. Silty Clay to Clay
- 5. Clayey Silt to Silty Clay
- 6. Sandy Silt to Clayey Silt
- 7. Silty Sand to Sandy Silt
- 8. Sand and silty Sand
- 9. Sand
- 10. Gravelly Sand to Sand
- 11. Very Stiff Fine-Grained
- 12. Sand to Clayey Sand



CPT LOGS

Trembley Lane, Watsonville

FIGURE

A-12.2

Project No: 14034

Project: Trembley Lane Subdivision

Date: February 18, 2015

Borehole No: CPT-6

Groundwater Level: 13 Feet

Cone Area Ratio: 0.8

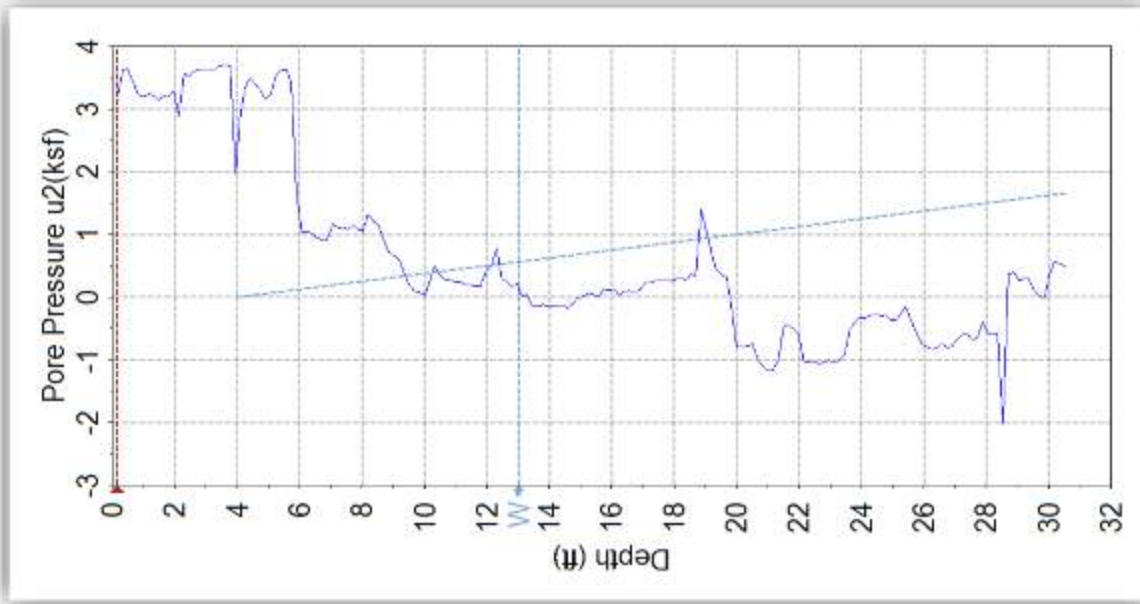
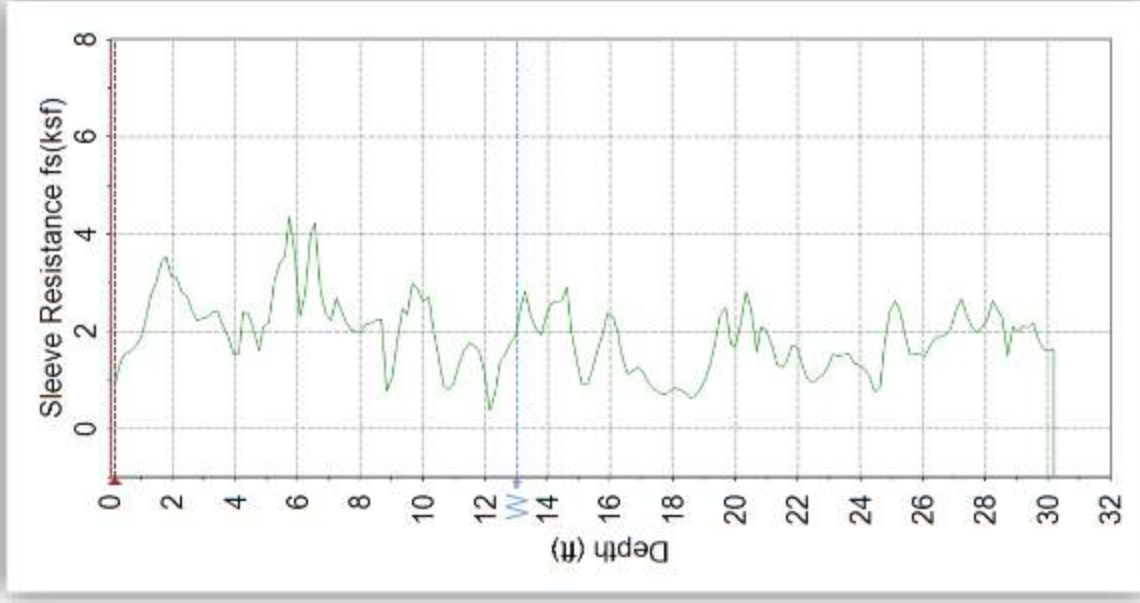
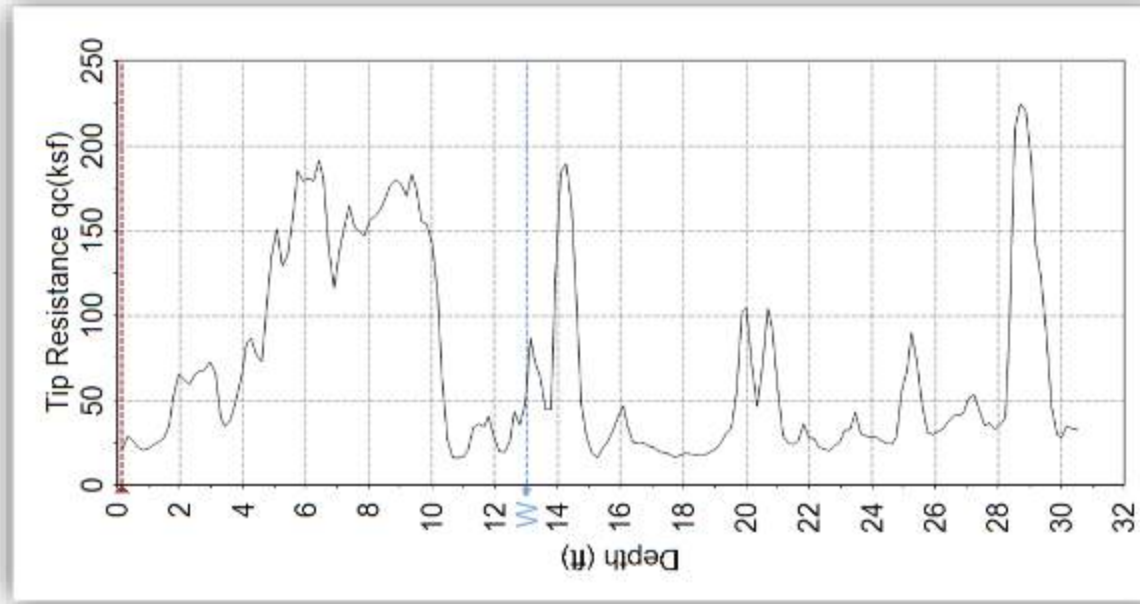

Project No: 14034

Project: Trembley Lane Subdivision

Date: February 18, 2015

Borehole No: CPT-6

Groundwater Level: 13 Feet

Cone Area Ratio: 0.8

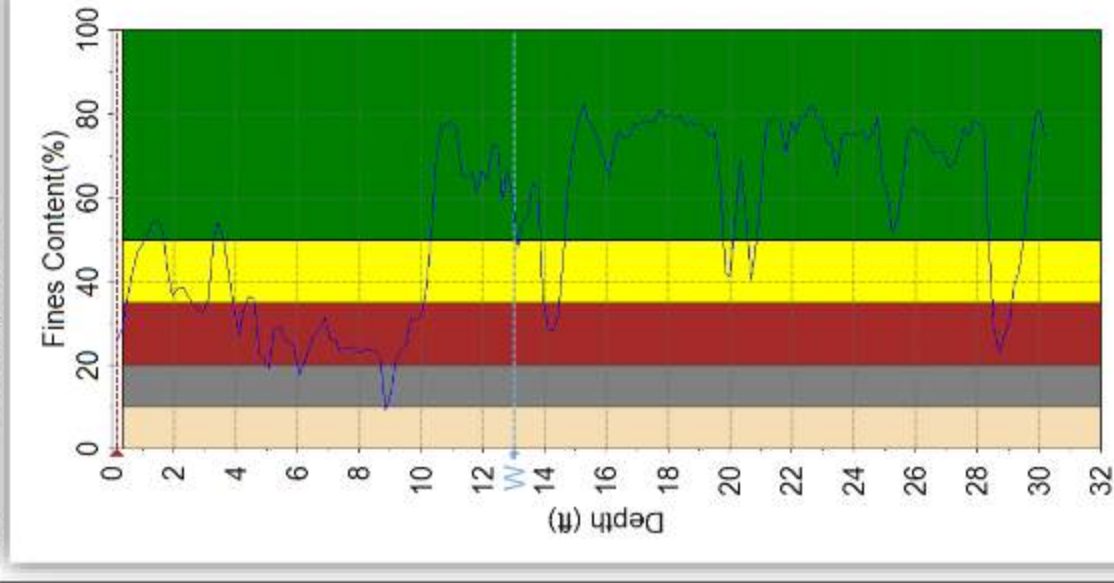

FC = 42.4179 % 51.8574

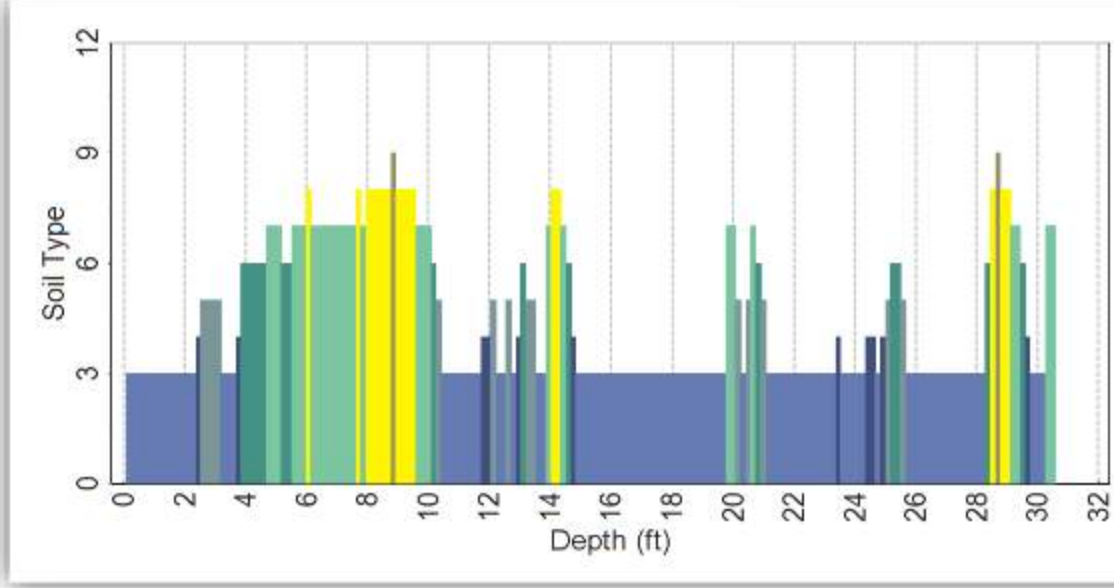

Robertson 1986 (SST)

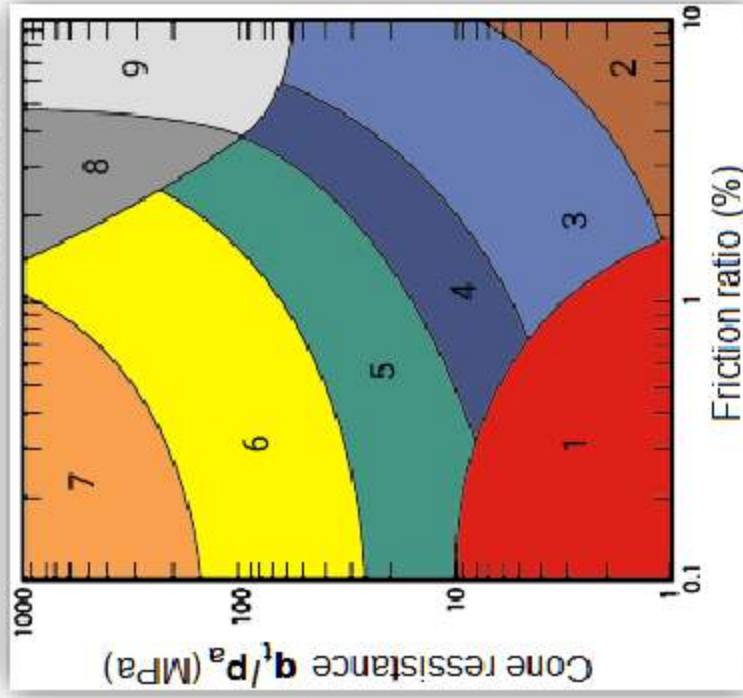

- 1. Sensitive Fines
- 2. Organic Material
- 3. Clay
- 4. Silty Clay to Clay
- 5. Clayey Silt to Silty Clay
- 6. Sandy Silt to Clayey Silt
- 7. Silty Sand to Sandy Silt
- 8. Sand and silty sand
- 9. Sand
- 10. Gravelly Sand to Sand
- 11. Very Stiff Fine-Grained
- 12. Sand to Clayey Sand

CPT LOGS

Trembley Lane, Watsonville

FIGURE

A-13.2



SUMMARY OF LABORATORY TEST RESULTS

BORING	DEPTH	SOIL TYPE	IN-SITU			DIRECT SHEAR		GRAIN SIZE (%)				EXPANSION INDEX	SOLUBLE SULFATES (ppm)
			DRY DENSITY (pcf)	MOISTURE CONTENT (%)	WET DENSITY (pcf)	COHESION (psf) (PEAK)	FRICTION ANGLE (PEAK)	GRAVEL	SAND	SILT	CLAY		
B1	0-1	SC		6.3									7
B1	1.0	SC	114.5	13.1	129.5					46		41	
B1	2.5	SC		13.5									
B1	5.0	SC	109.7	9.5	120.2								2
B1	6.5	SC		11.8									
B1	10.0	SC	102.5	23.6	126.7	330	33						
B1	11.5	SC		19.2									
B1	15.0	SM/SC		27.6									
B1	20.0	SM/SC		36.8									
B1	25.0	SM/SC		27.8									
B1	30.0	SM/SC		36.0									
B2	1.0	SC	109.6	9.3	119.8								
B2	2.5	SC		8.5									
B2	5T	SC	111.0	8.5	120.4								
B2	5B	ML		24.7									
B2	6.5T	ML		24.1									
B2	6.5B	SC		17.5									
B2	10.0	SM/SC	105.9	15.1	121.9								
B2	11.5	SM/SC		31.4									
B3	0.5	SC	102.5	12.3	115.1								3
B3	2.0	CL		23.6						68		155	

SUMMARY OF LABORATORY TEST RESULTS

BORING	DEPTH	SOIL TYPE	IN-SITU			DIRECT SHEAR		GRAIN SIZE (%)				EXPANSION INDEX	SOLUBLE SULFATES (ppm)
			DRY DENSITY (pcf)	MOISTURE CONTENT (%)	WET DENSITY (pcf)	COHESION (psf) (PEAK)	FRICTION ANGLE (PEAK)	GRAVEL	SAND	SILT	CLAY		
B3	5.0	CL	103.9	15.7	120.2								10
B3	6.5T	SP		26.8									
B3	6.5B	SC		19.3									
B3	10T	SC		23.0									
B3	10B	CH		27.9									
B3	15.0	SM/CL		34.2									
B3	20.0	ML		44.6									
B4	1.0	SC		12.6		0	35						4
B4	2.5	CL		18.7									
B4	5.0	CL	100.6	21.1	121.8								
B4	10.0	SM/SC	104.7	19.1	124.6								
B4	15.0	SM/SC		32.2									
B5	1.0	SC	112.9	9.5	123.7					38			
B5	2.5	SC		11.0									
B5	5.0	CL	114.7	14.6	131.5								
B5	6.5	SC		19.8									

BORING:	B4		COHESION	FRICTION
DEPTH (ft):	1.0		(psf)	ANGLE
SOIL TYPE (USCS):	SC		0	35
			0	33
TEST SAMPLE TYPE:		FIELD MOISTURE:	12.6%	
IN-SITU (SATURATED)		SATURATED MOIST:	25.7%	

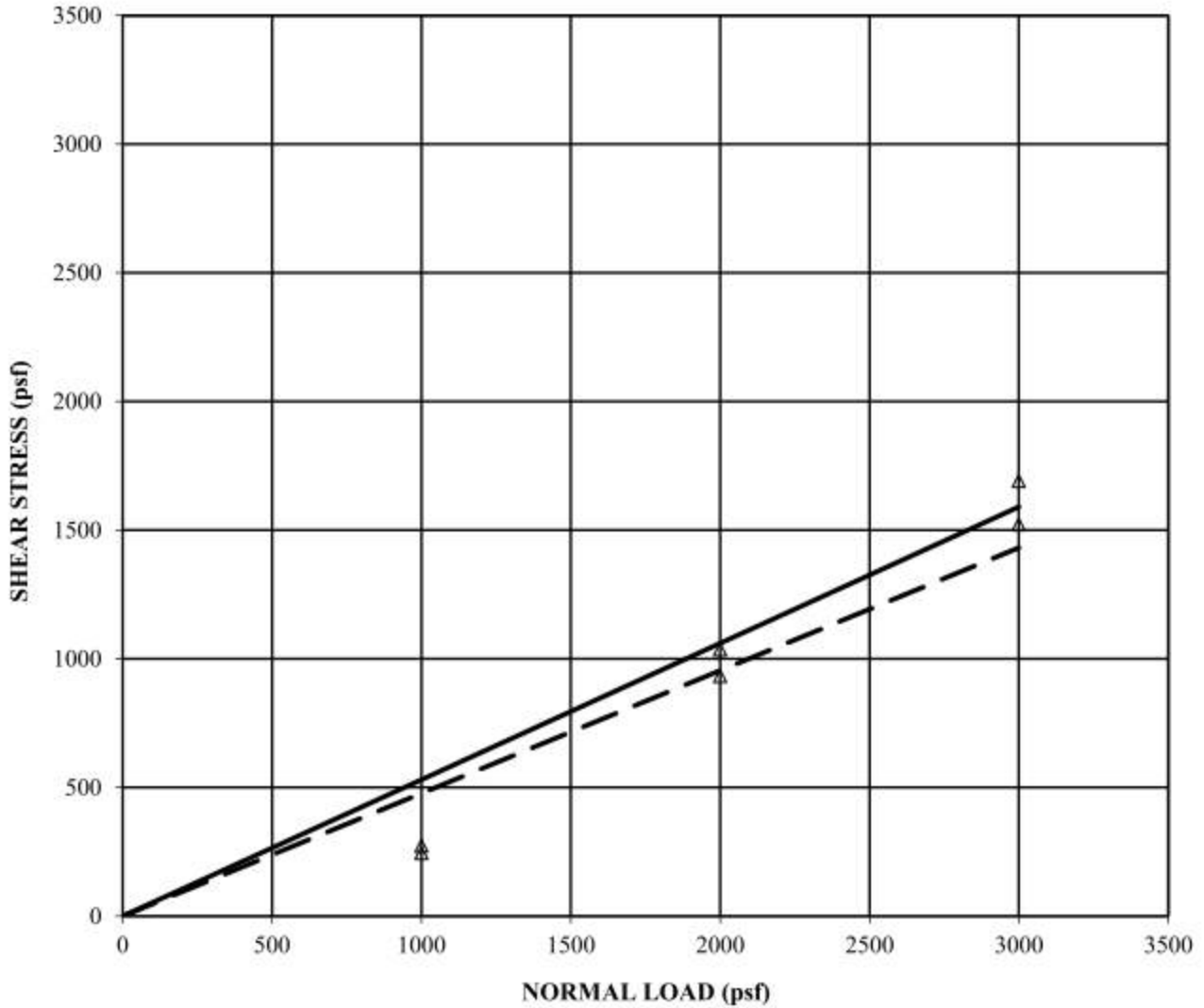

BORING:	B1		COHESION	FRICTION
DEPTH (ft):	10.0		(psf)	ANGLE
SOIL TYPE (USCS):	SC	————— PEAK	330	33
		- - - - - RESIDUAL	320	28
TEST SAMPLE TYPE:		FIELD MOISTURE:	23.6%	
IN-SITU (SATURATED)		SATURATED MOIST:	25.1%	

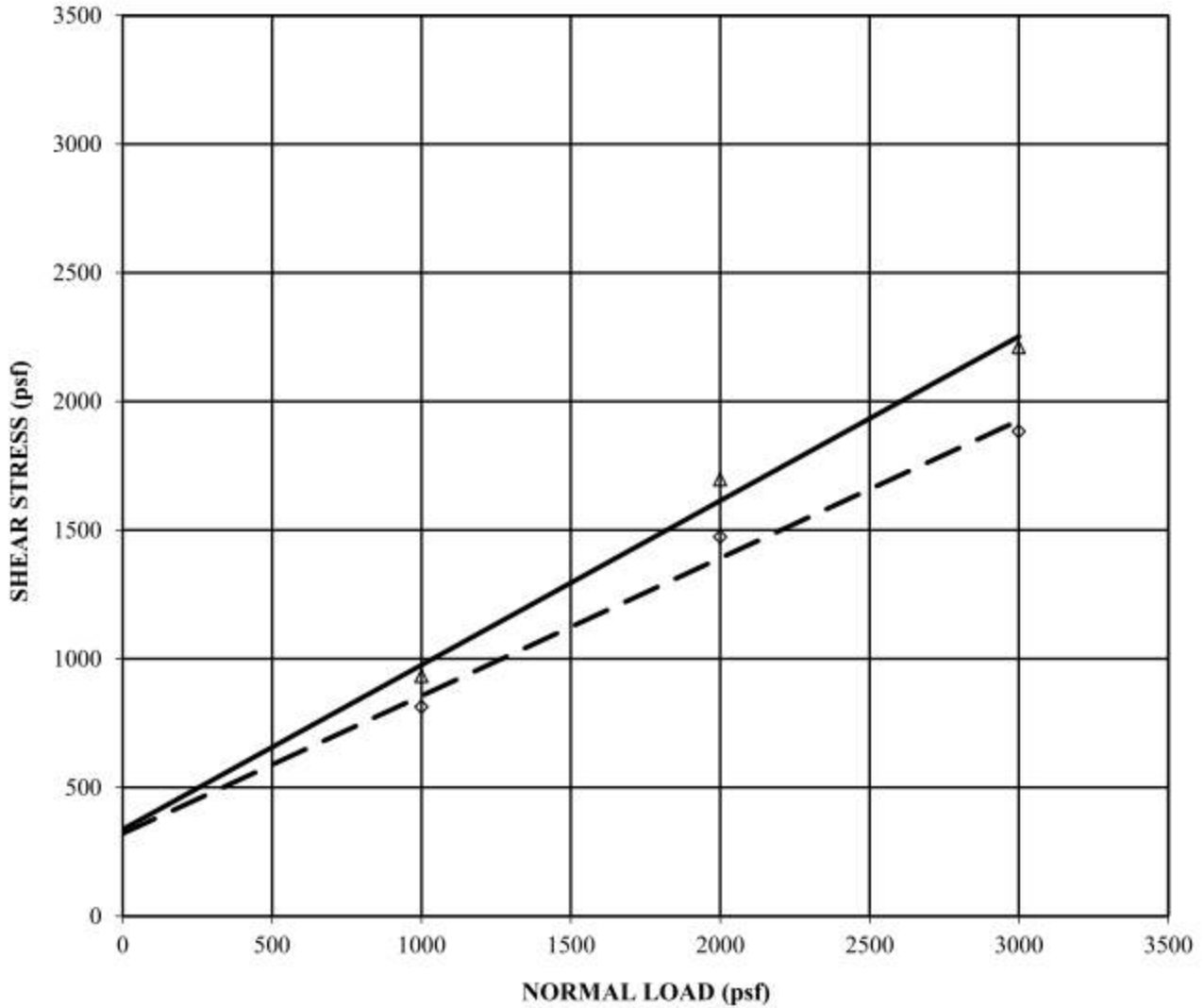

BORING:	B2	— FIELD MOISTURE	
DEPTH (ft):	1.0	- - - SATURATED	
SOIL TYPE (USCS):	SC REBOUND	
SEATING WEIGHT:	250 psf	FIELD MOISTURE:	9.3%
		SATURATED MOIST:	17.1%

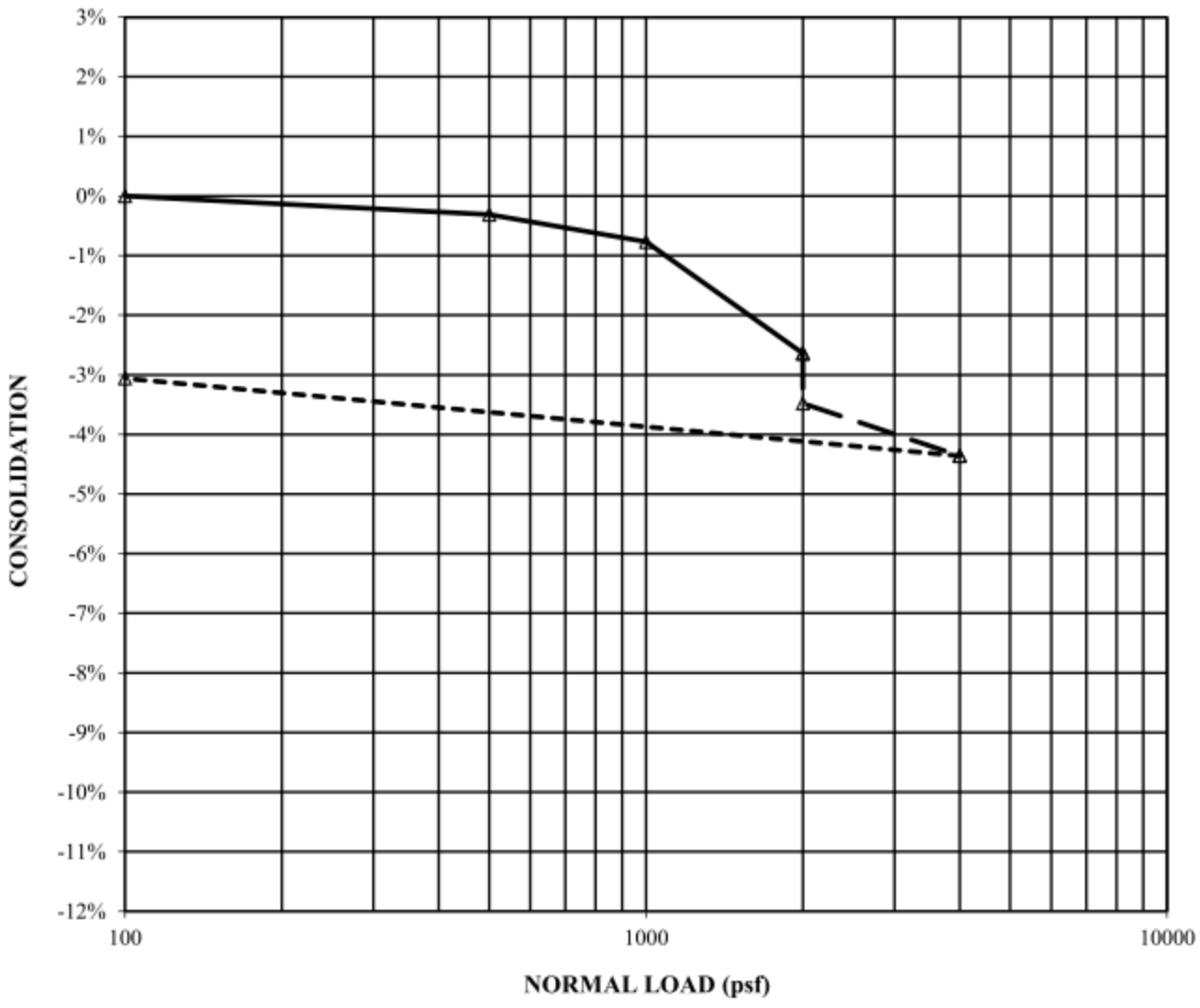

BORING:	B3	— FIELD MOISTURE	
DEPTH (ft):	0.5	- - - SATURATED	
SOIL TYPE (USCS):	SC REBOUND	
SEATING WEIGHT:	220 psf	FIELD MOISTURE:	12.3%
		SATURATED MOIST:	17.9%

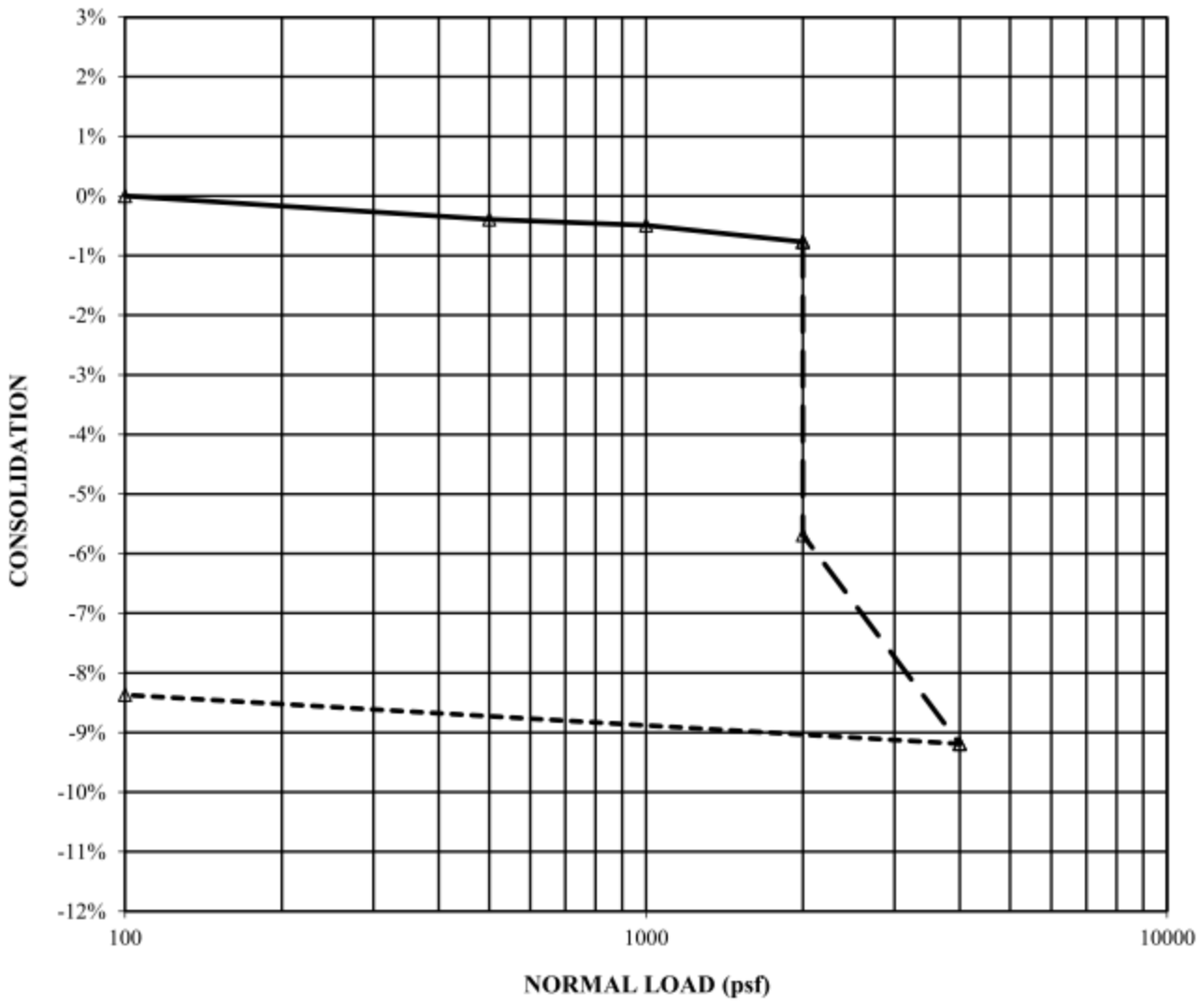

BORING:	B3
DEPTH (ft):	15.0
SOIL TYPE (USCS):	SM

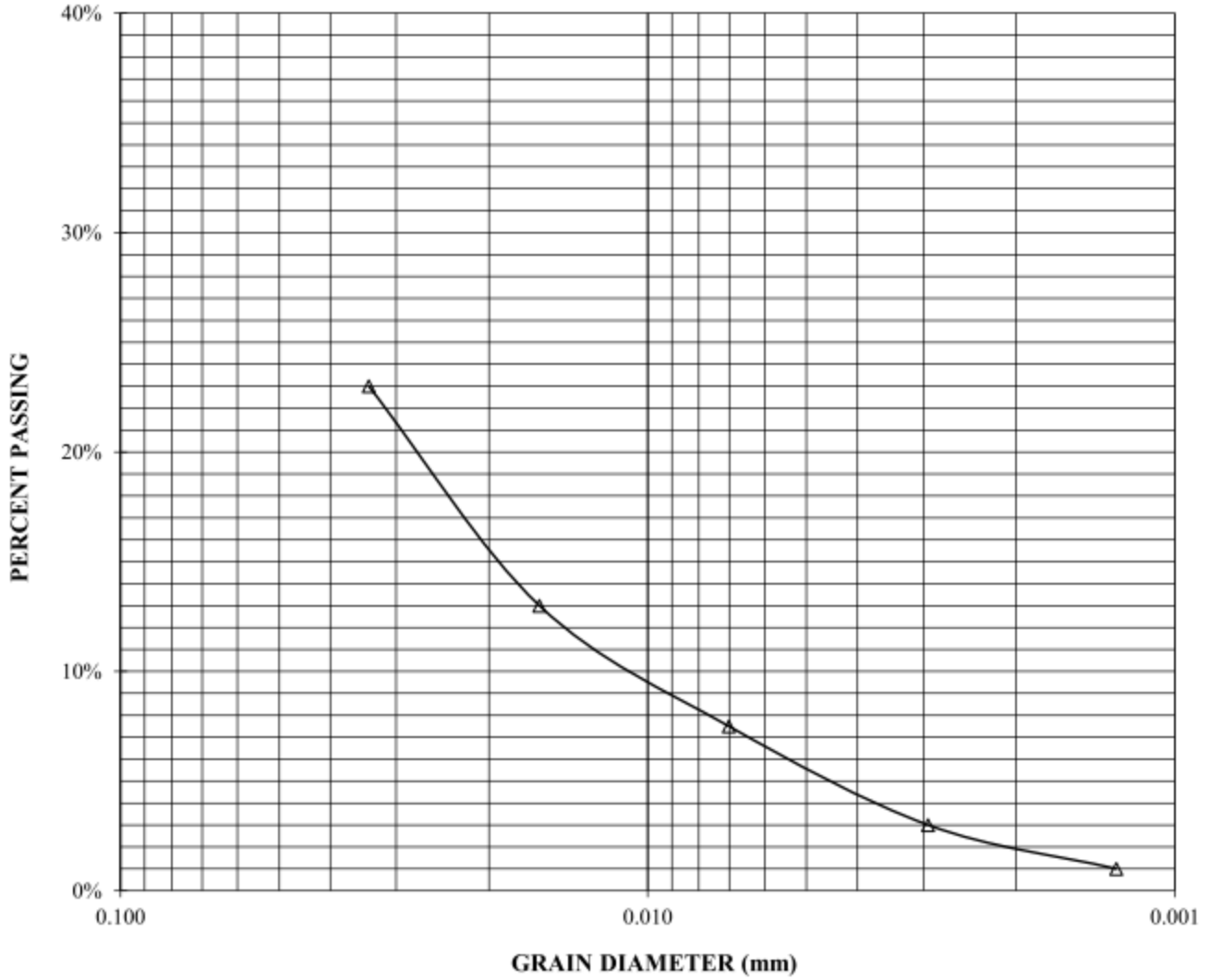

BORING:	B1
DEPTH (ft):	20.0
SOIL TYPE (USCS):	SM/SC

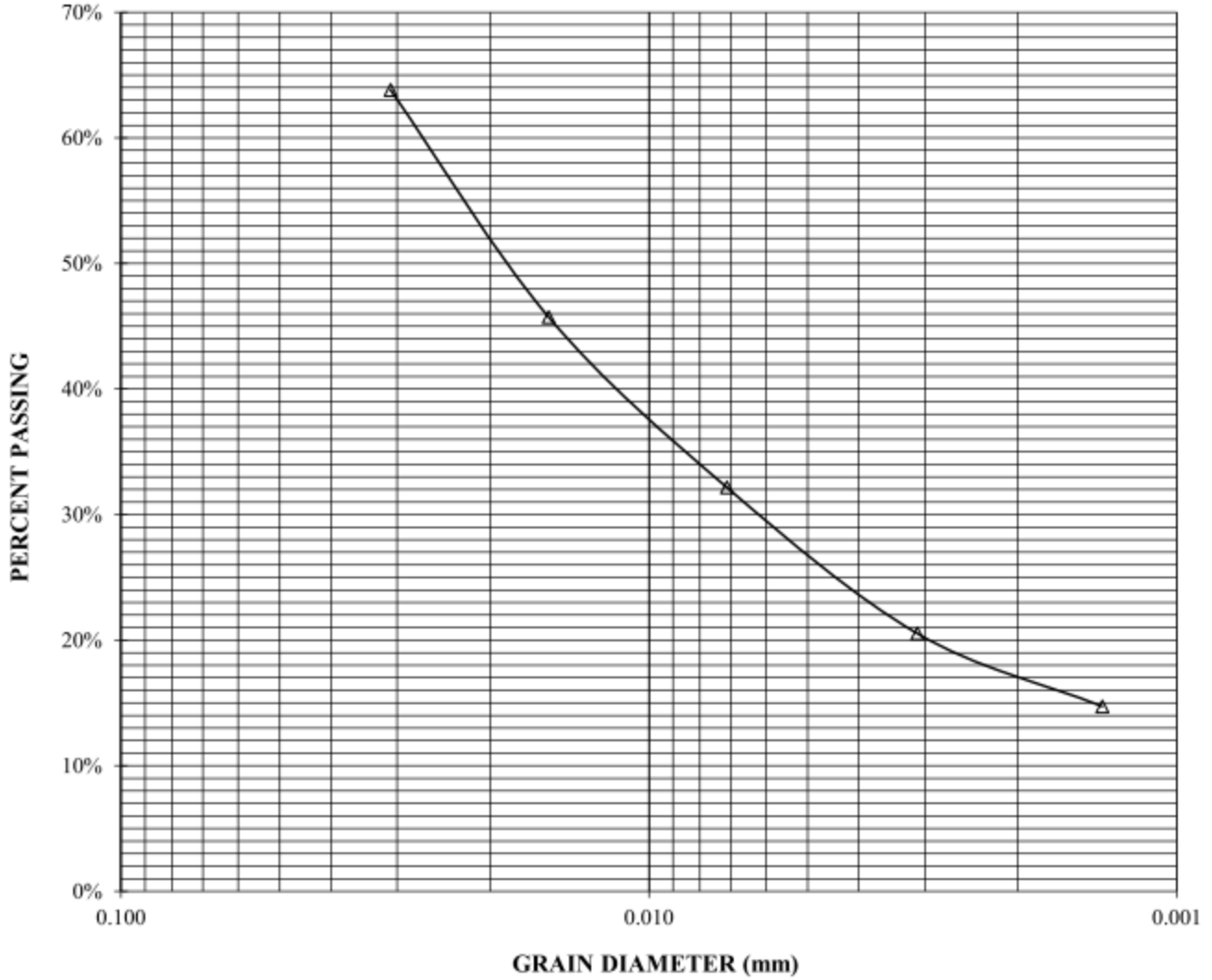

APPENDIX B

LIQUEFACTION ANALYSIS

- Methodology Page B-1
- Results Figures B-1 through B-6

METHODOLOGY

- B-1. Our quantitative liquefaction analysis was performed on the observed soil configuration which is considered representative of the conditions at the subject site.
- B-2. The analysis uses empirical predictions of earthquake-induced liquefaction potential and was performed using the software NovoCPT by Novo Tech Software Ltd. (Reference 8). This analysis is based on a comparison of the in-situ cyclic stress ratio (CSR) with the CSR from historical data collected in areas which experienced liquefaction for a given magnitude earthquake and soil configuration.
- B-3. The design seismic event was assumed to occur along the San Andreas Fault with a corresponding magnitude of $M=7.9$. Our analysis was performed assuming a peak ground acceleration (PGA_M) of 0.56g in accordance with Geologic Investigation (Reference 5).
- B-4. Grain size distribution, in-situ water content, and density were determined for samples considered representative of the potentially liquefiable soils encountered. The results of our laboratory testing are presented in Appendix A.
- B-5. The results of our calculations are presented in **Figures B-1 through B-6**.

Project No: 14034

Project: Trembley Lane Subdivision

Date: February 18, 2015

Borehole No: CPT-1

Groundwater Level: 5 Feet

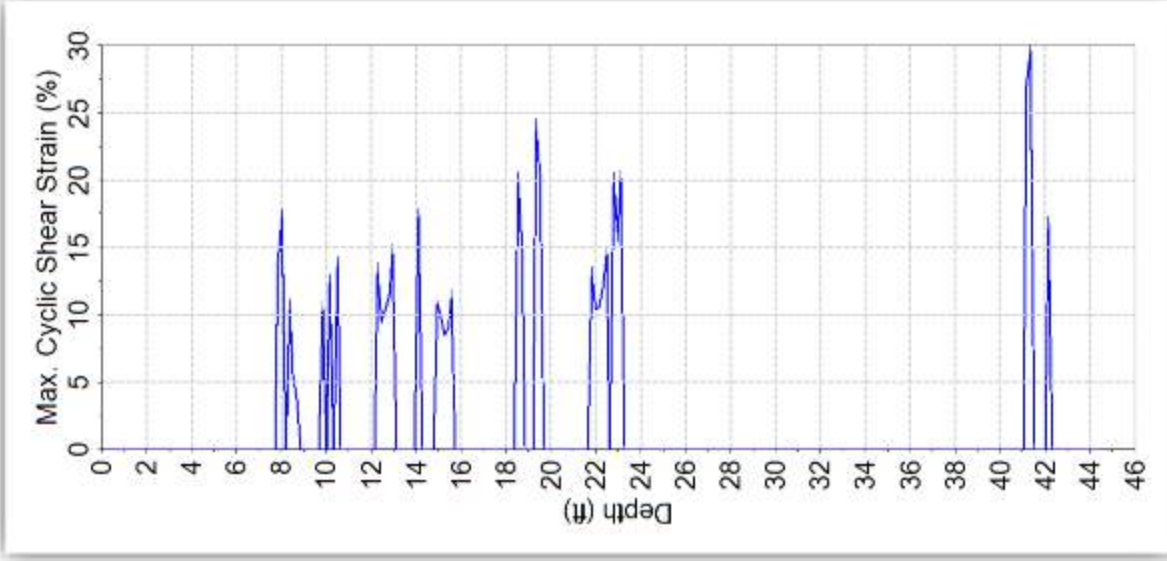
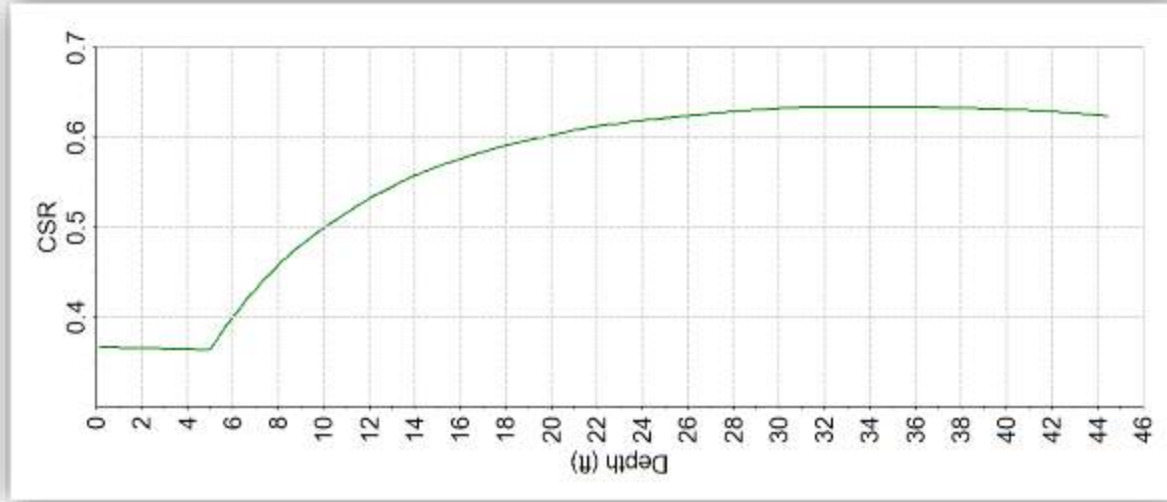
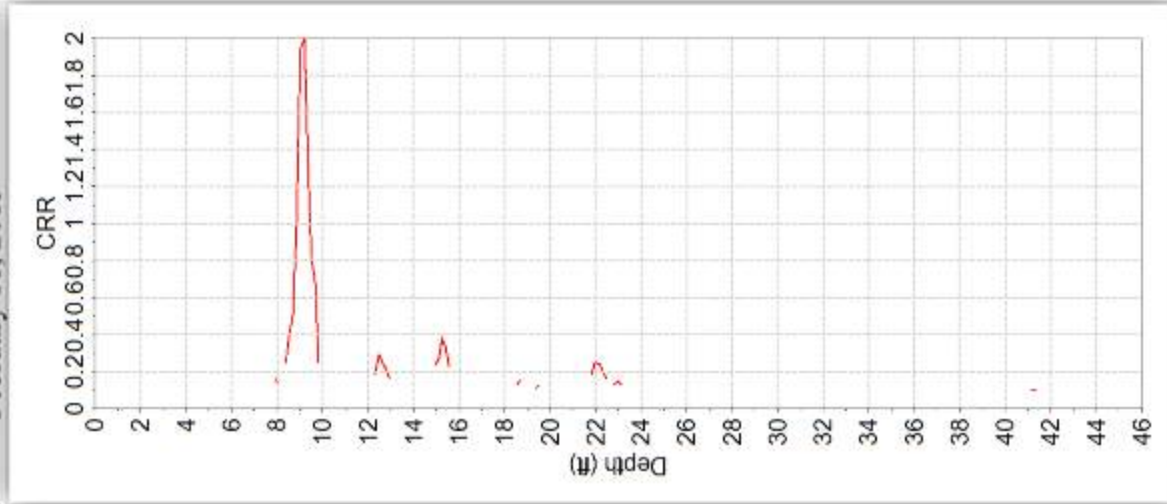

Project No: 14034

Project: Trembley Lane Subdivision

Date: February 18, 2015

Borehole No: CPT-1

Groundwater Level: 5 Feet

Cone Area Ratio: 0.8

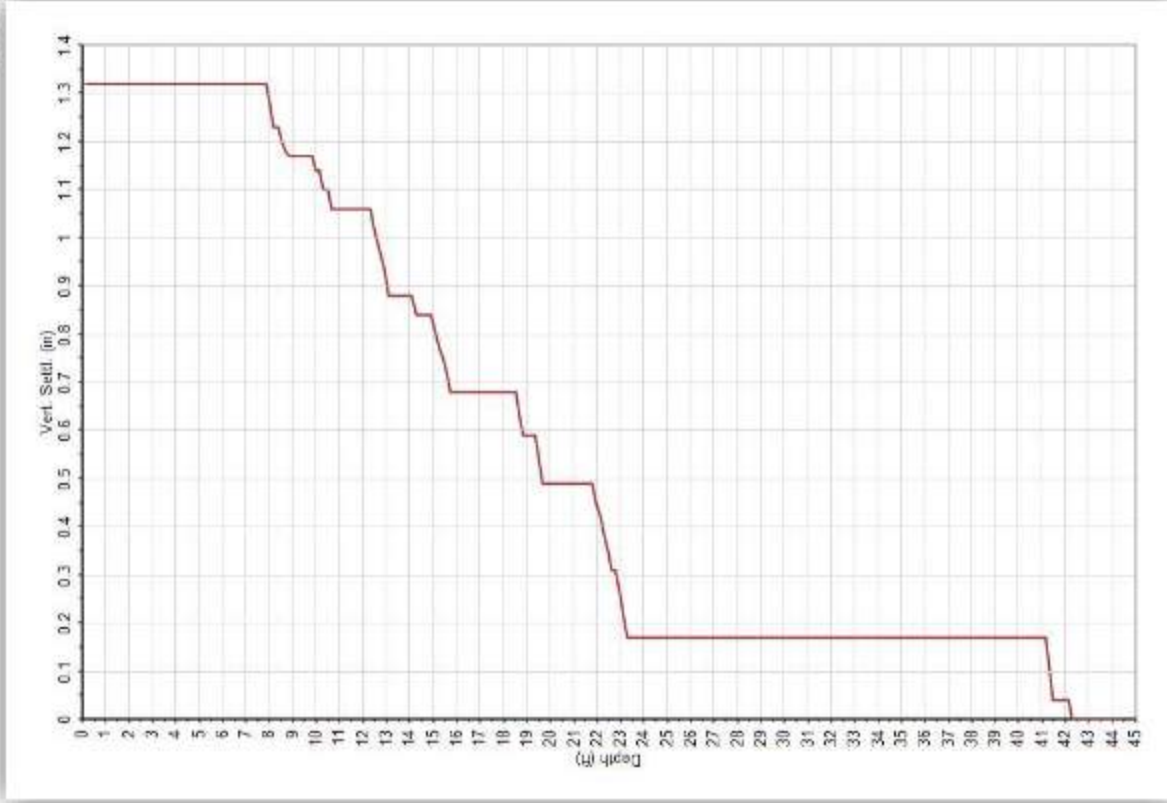
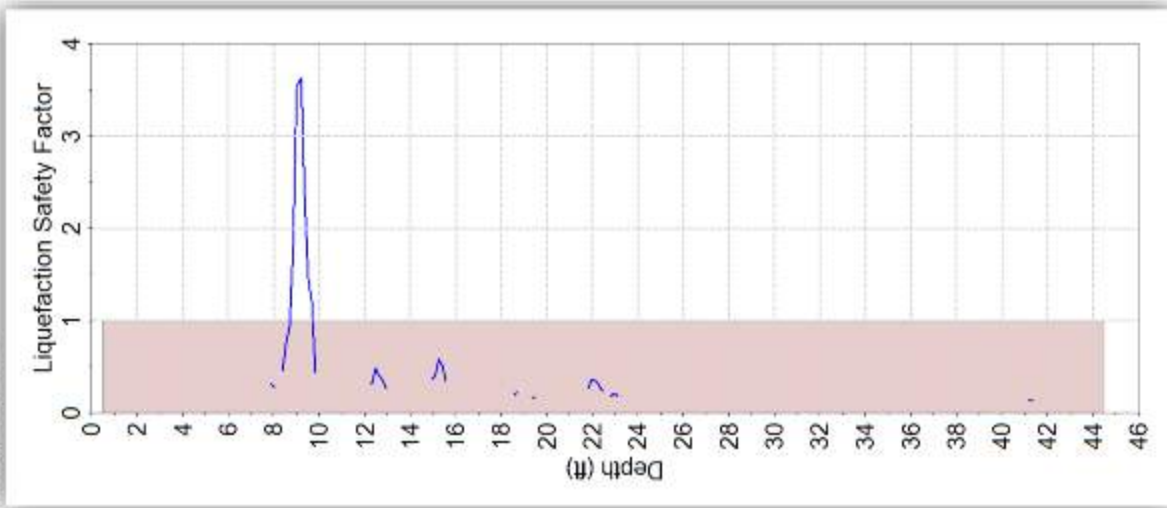

LIQUEFACTION RESULTS
Trembley Lane, Watsonville

FIGURE
B-1.2

Project No: 14034

Project: Trembley Lane Subdivision

Date: February 18, 2015

Borehole No: CPT-2

Groundwater Level: 7 Feet

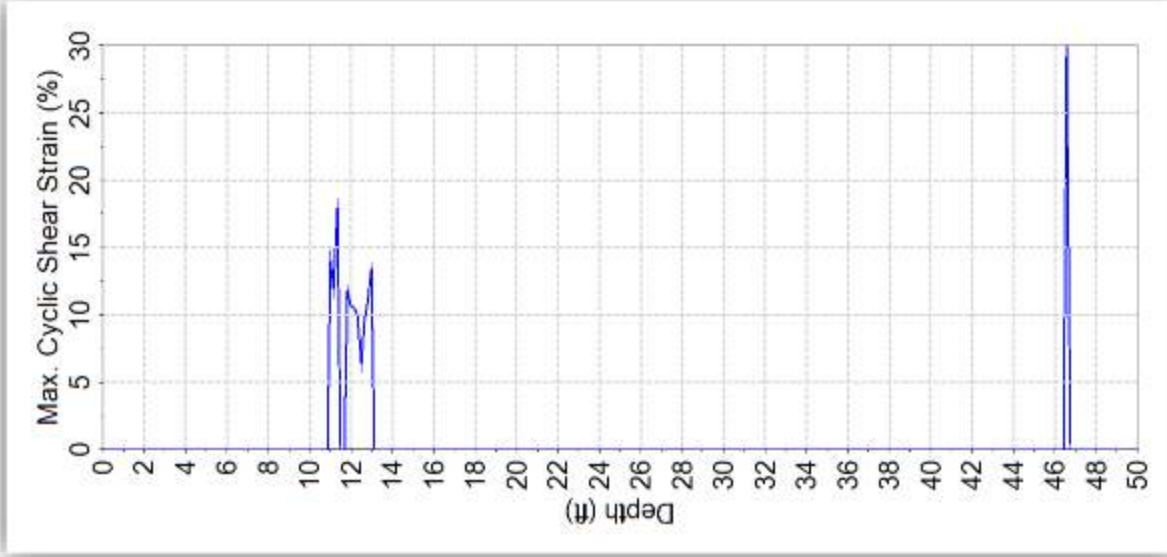
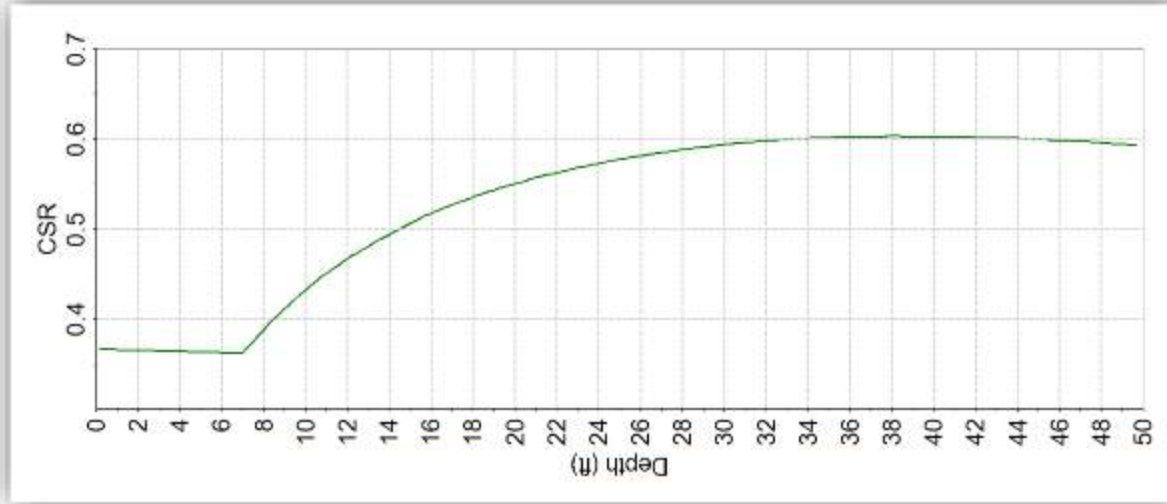
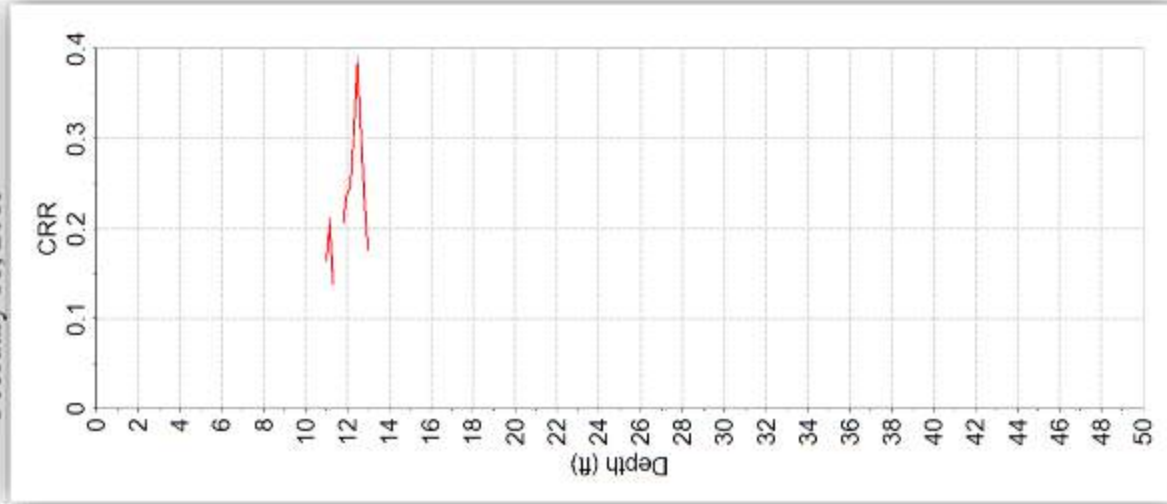

Project No: 14034

Project: Trembley Lane Subdivision

Date: February 18, 2015

Borehole No: CPT-2

Groundwater Level: 7 Feet

Cone Area Ratio: 0.8

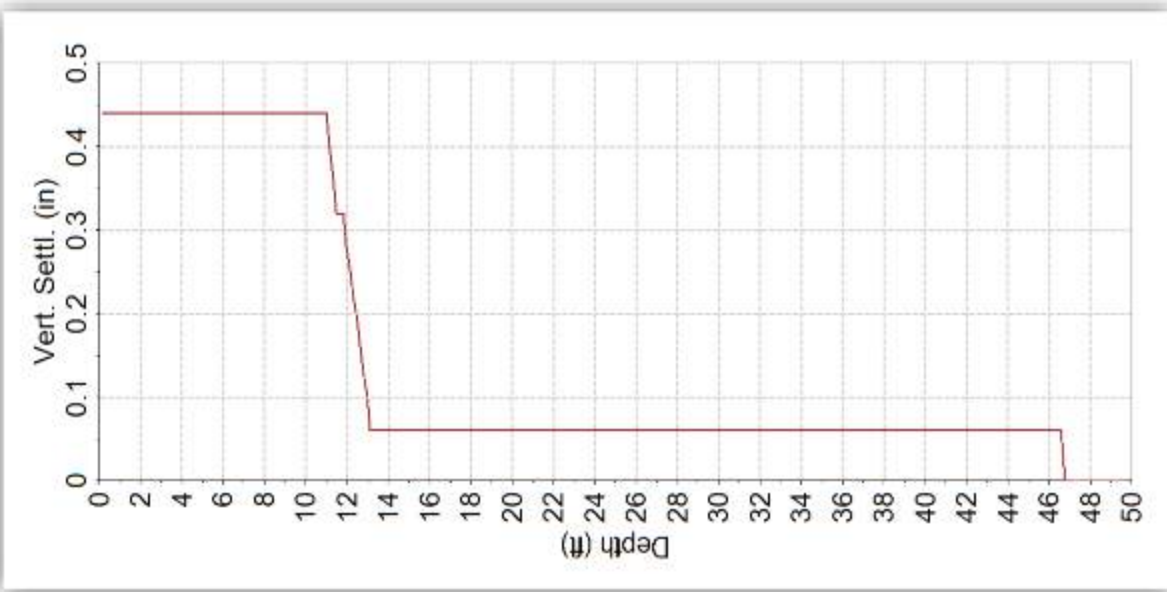
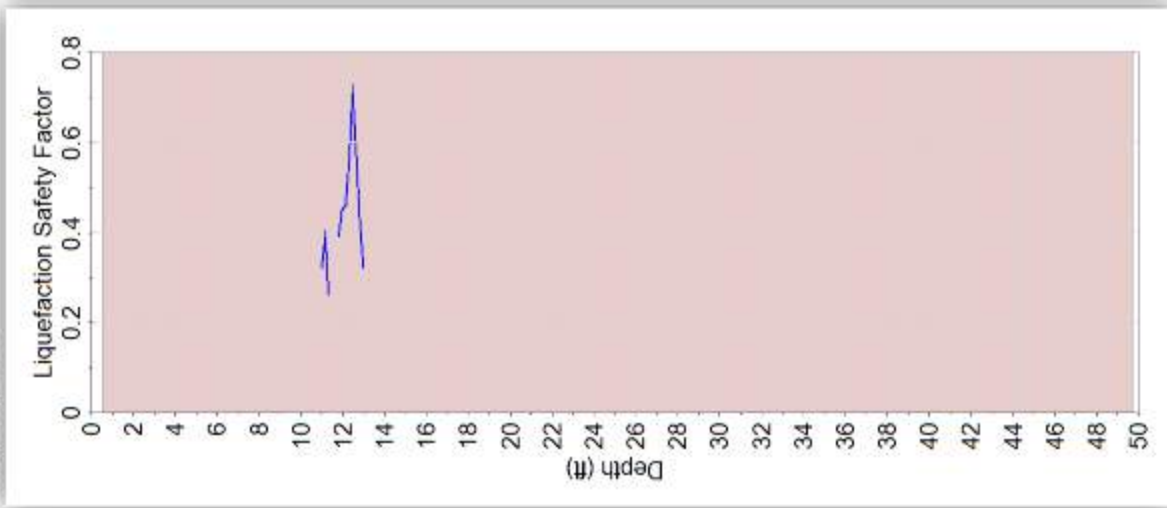

LIQUEFACTION RESULTS

Trembley Lane, Watsonville

FIGURE

B-2.2

Project No: 14034

Project: Trembley Lane Subdivision

Date: February 18, 2015

Borehole No: CPT-3

Groundwater Level: 16 Feet

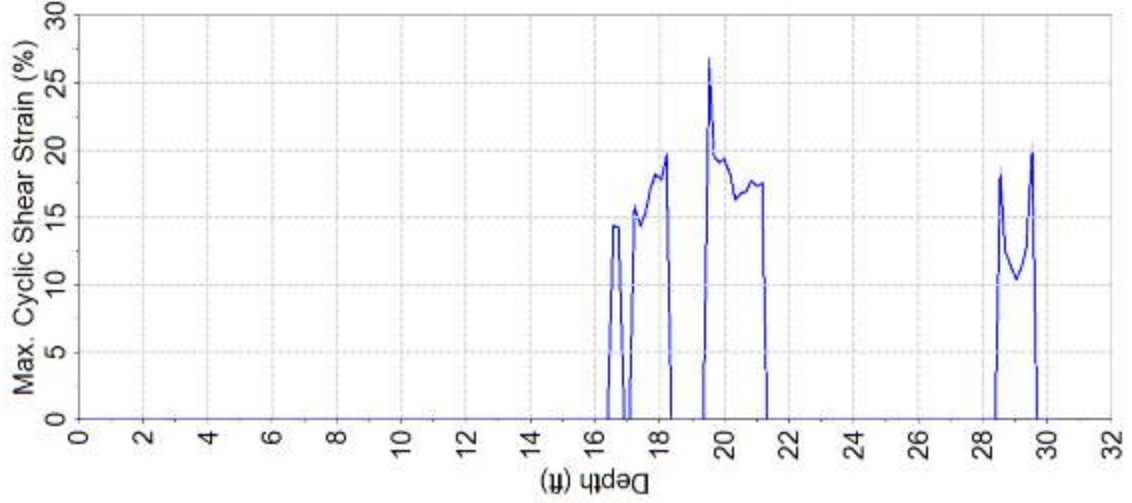
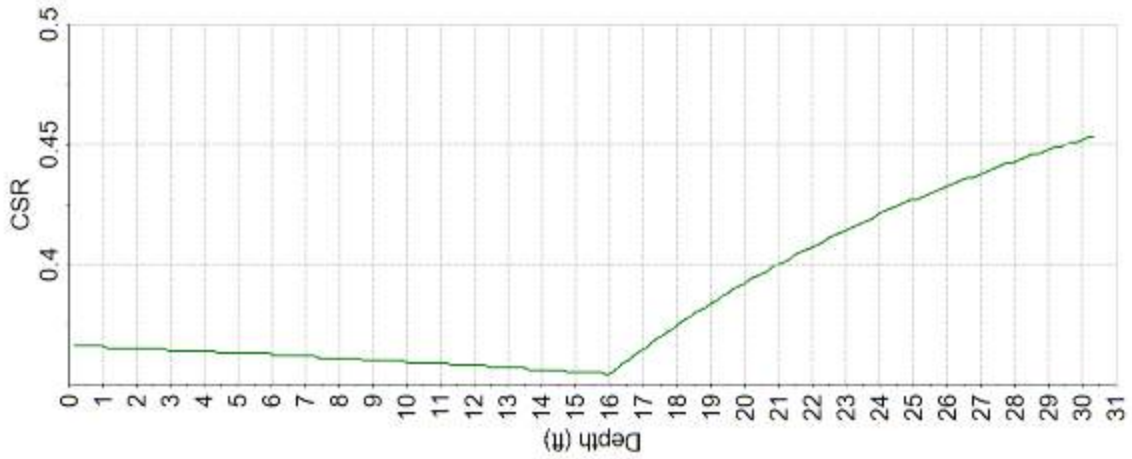
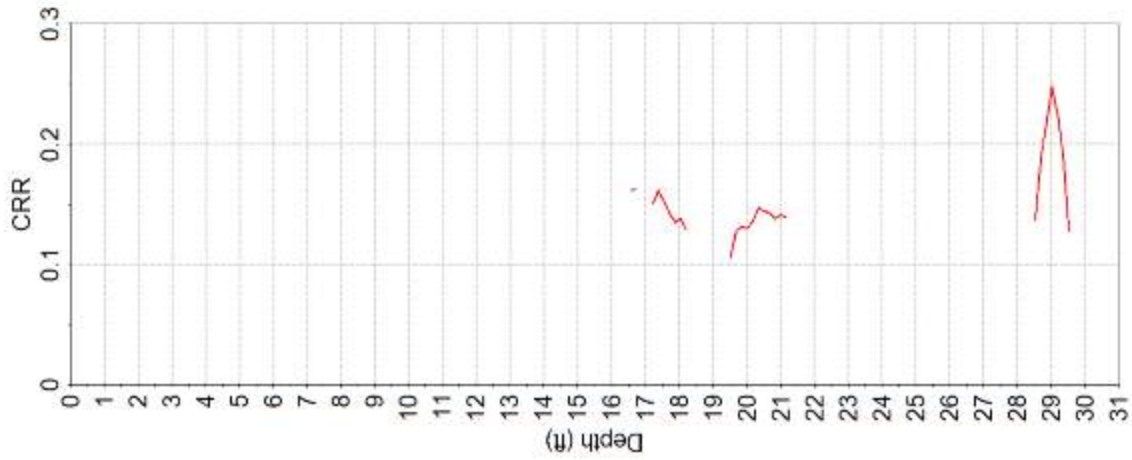

Project No: 14034

Project: Trembley Lane Subdivision

Date: February 18, 2015

Borehole No: CPT-3

Groundwater Level: 16 Feet

Cone Area Ratio: 0.8

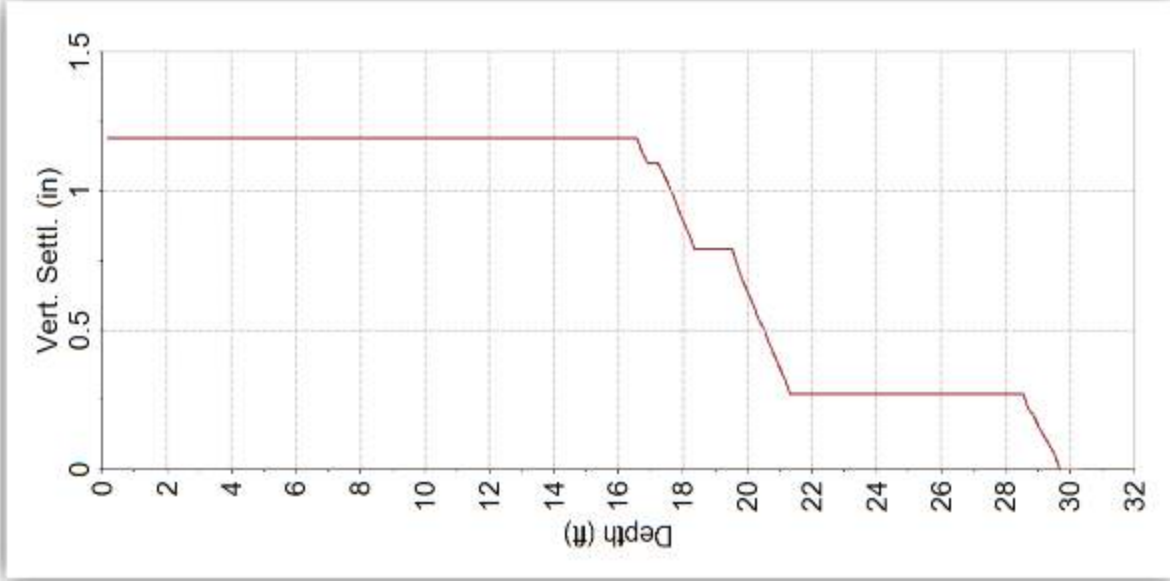
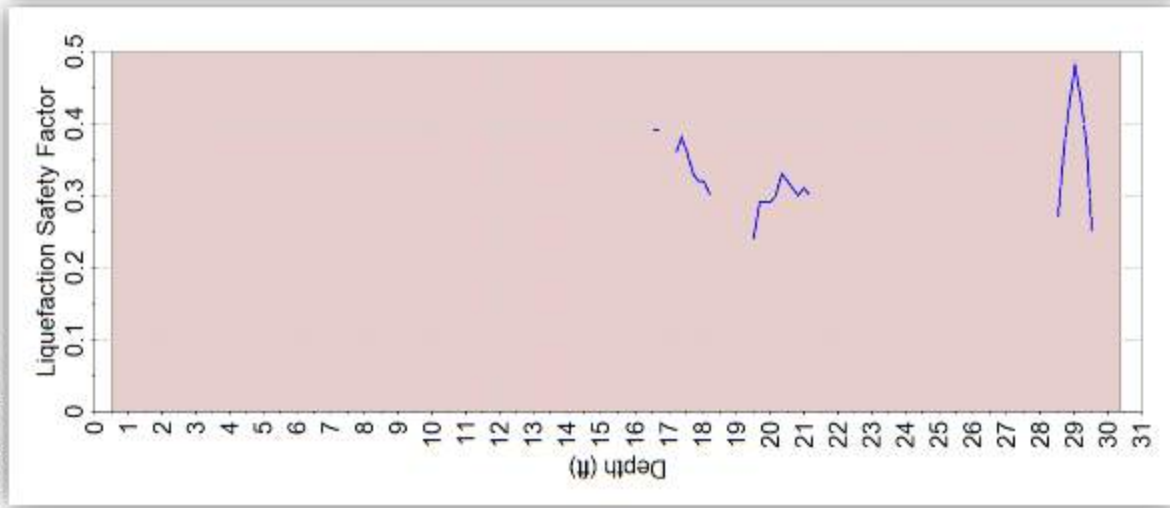

LIQUEFACTION RESULTS

Trembley Lane, Watsonville

FIGURE

B-3.2

Project No: 14034

Project: Trembley Lane Subdivision

Date: February 18, 2015

Borehole No: CPT-4

Groundwater Level: 13 Feet

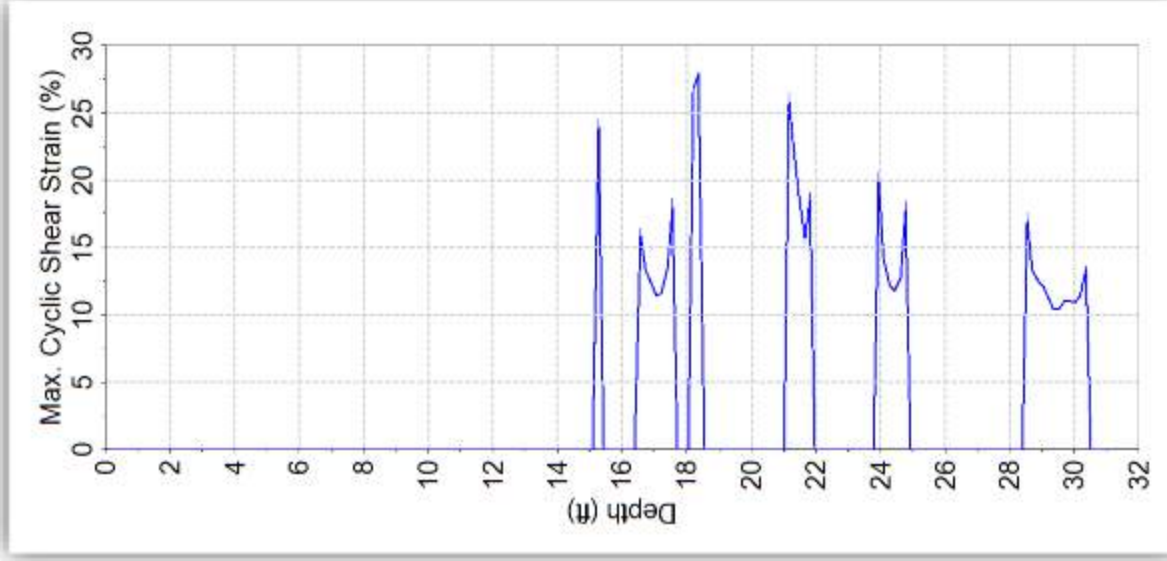
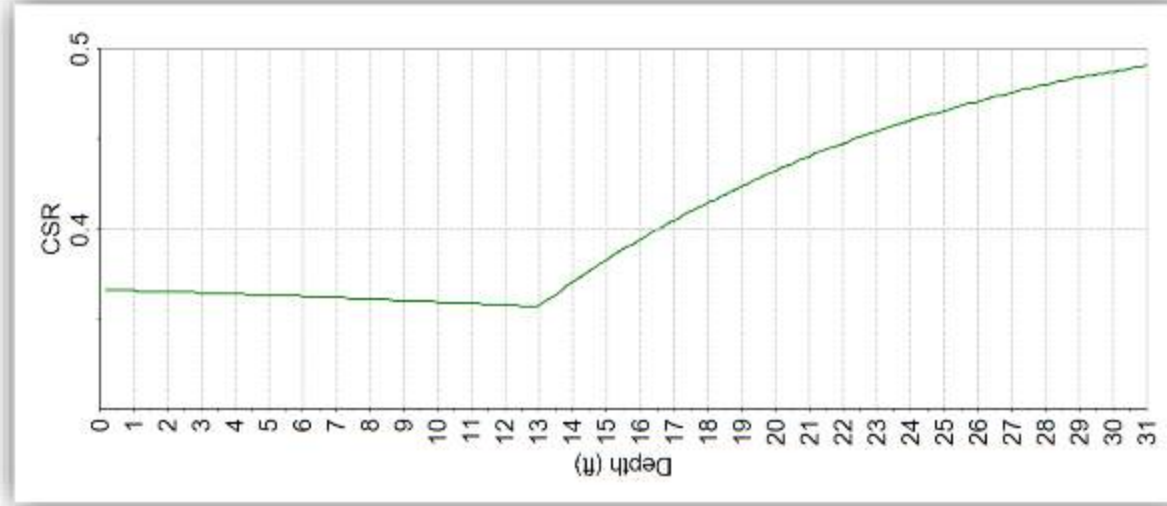
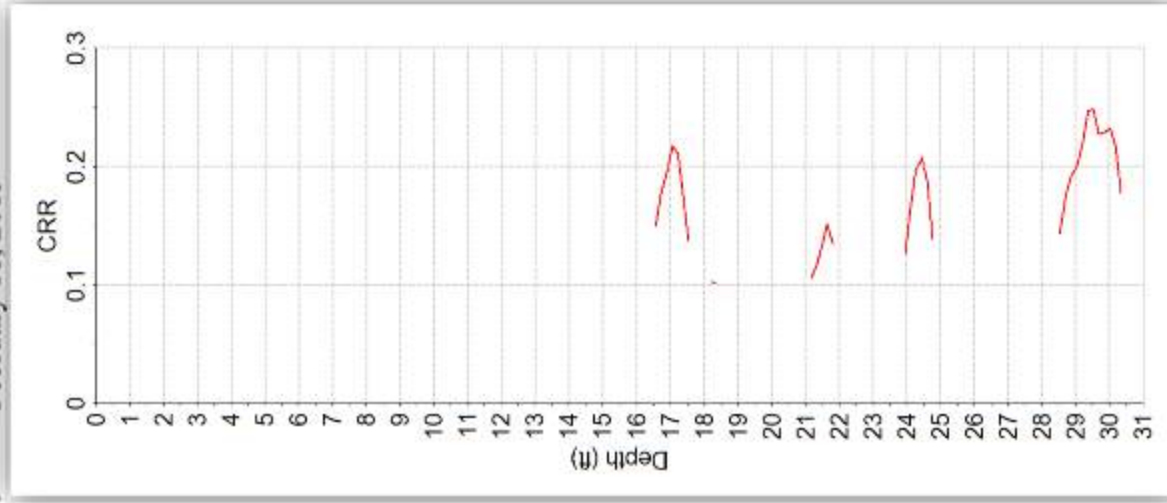

Project No: 14034

Project: Trembley Lane Subdivision

Date: February 18, 2015

Borehole No: CPT-4

Groundwater Level: 13 Feet

Cone Area Ratio: 0.8

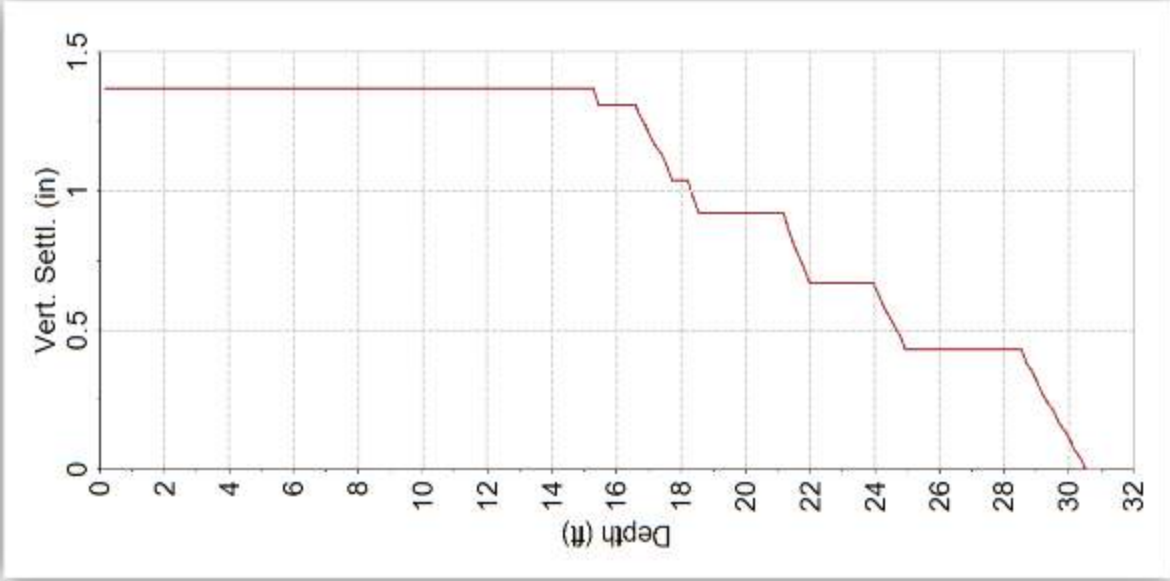
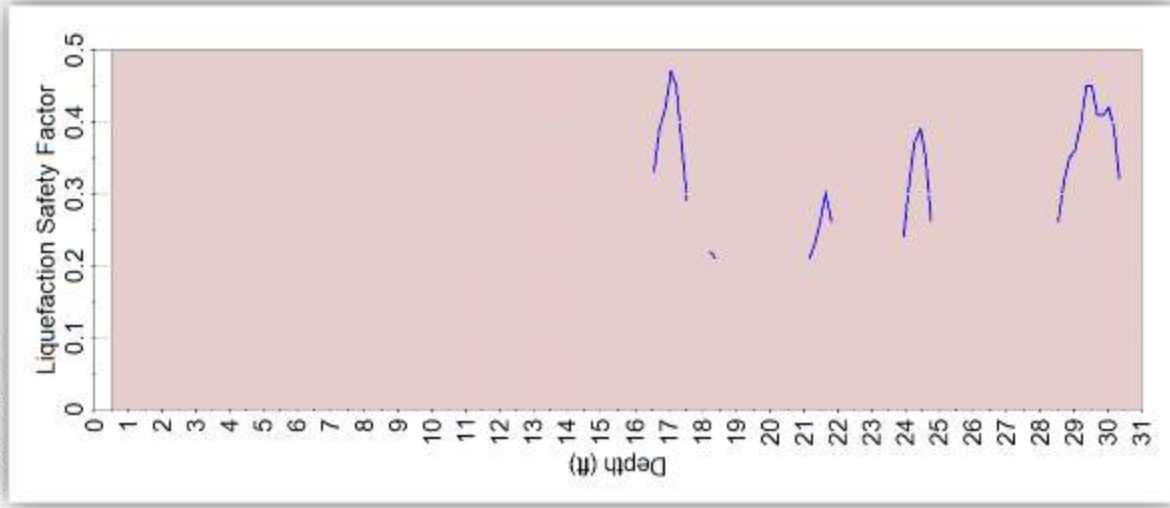

LIQUEFACTION RESULTS
Trembley Lane, Watsonville

FIGURE
B-4.2

Project No: 14034

Project: Trembley Lane Subdivision

Date: February 18, 2015

Borehole No: CPT-5

Groundwater Level: 13 Feet

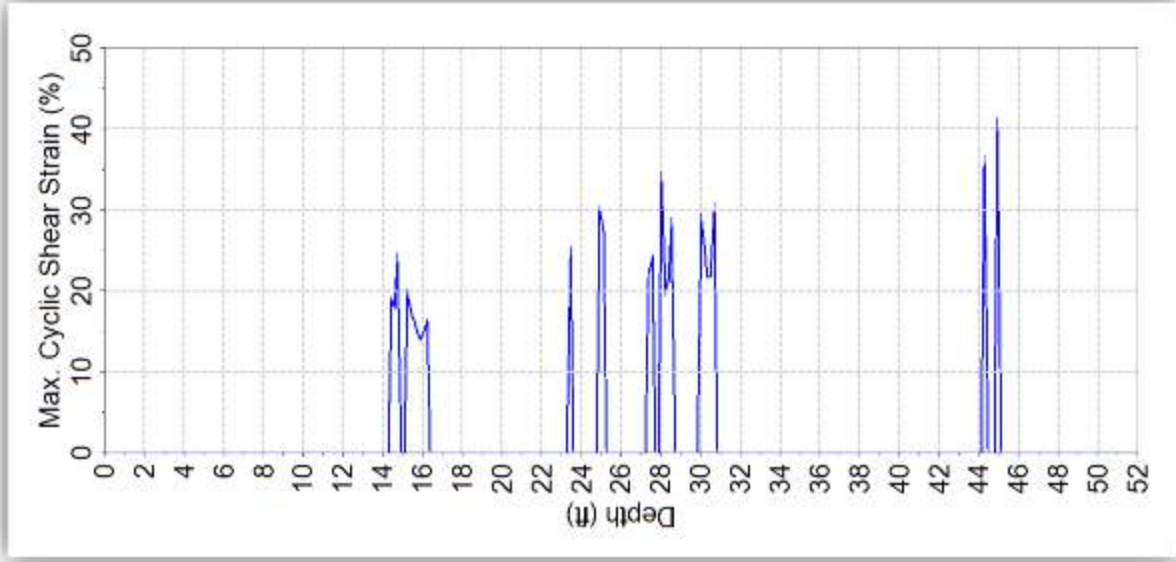
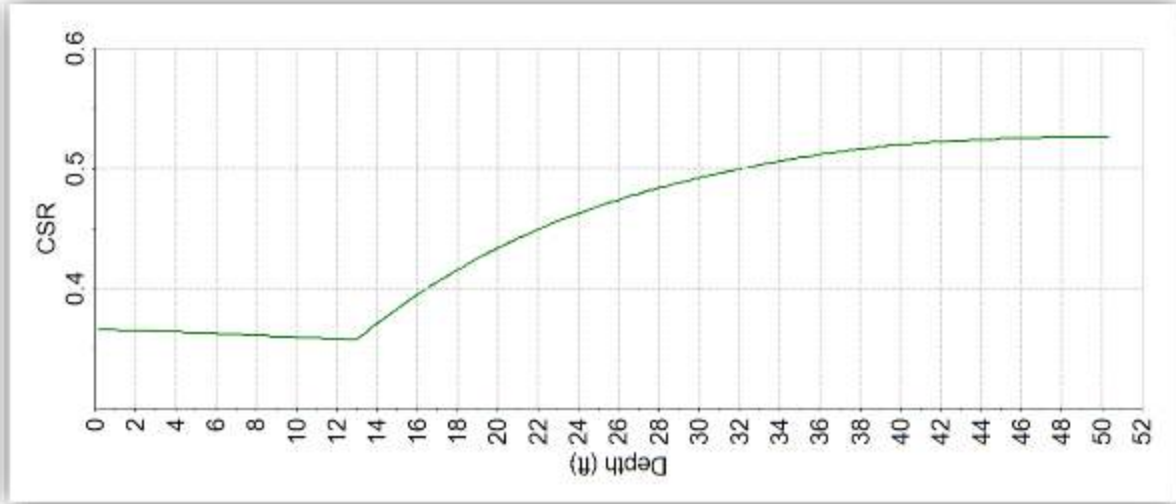
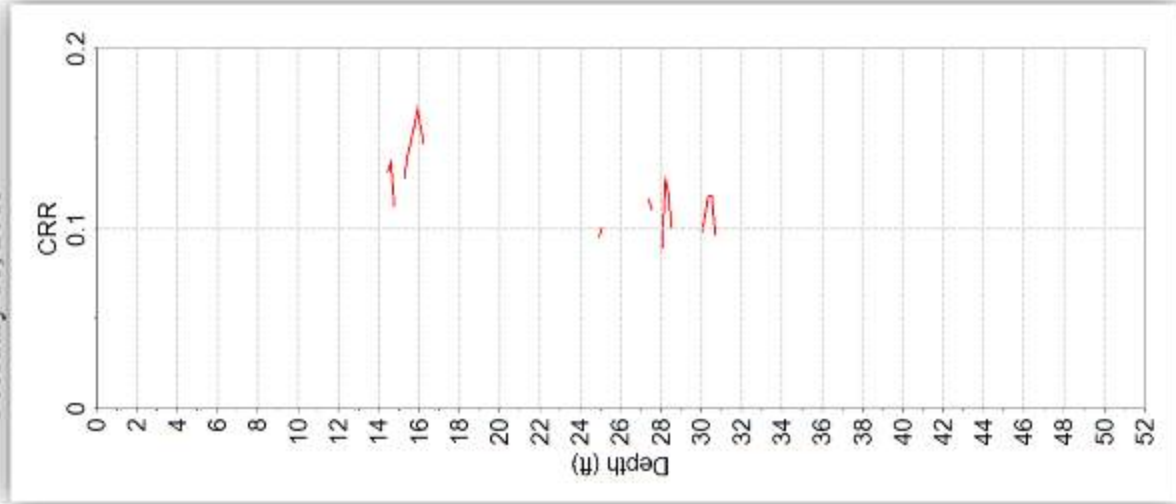

Project No: 14034

Project: Trembley Lane Subdivision

Date: February 18, 2015

Borehole No: CPT-5

Groundwater Level: 13 Feet

Cone Area Ratio: 0.8

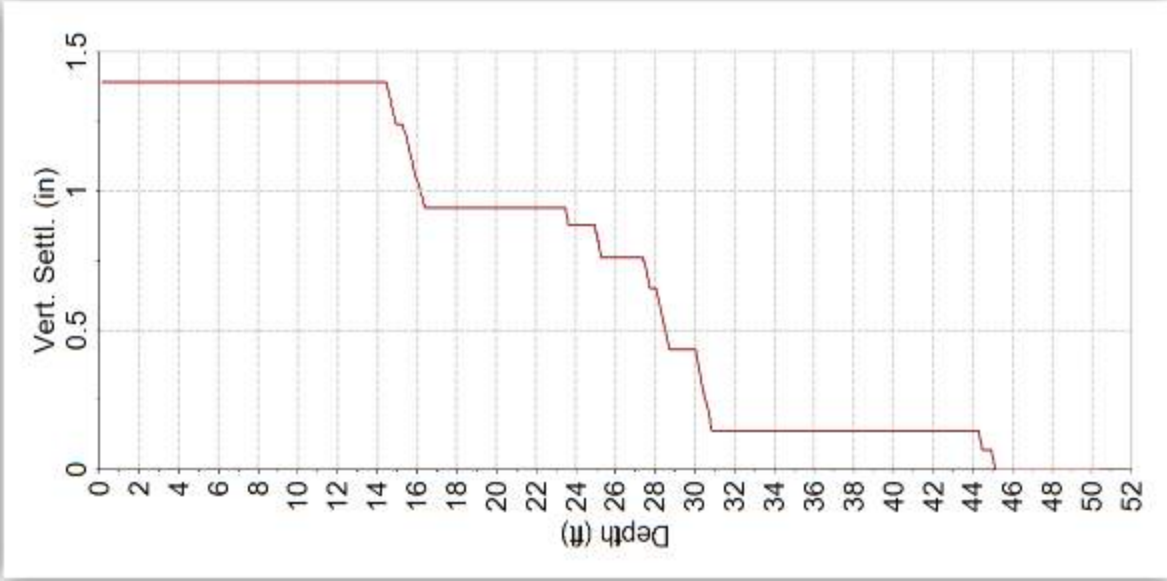
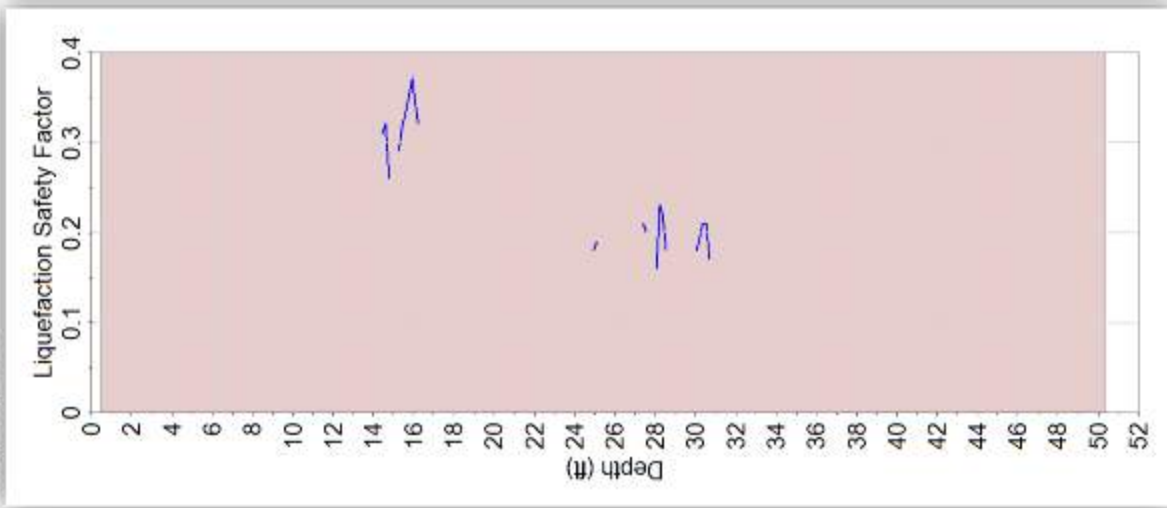

Project No: 14034

Project: Trembley Lane Subdivision

Date: February 18, 2015

Borehole No: CPT-6

Groundwater Level: 13 Feet

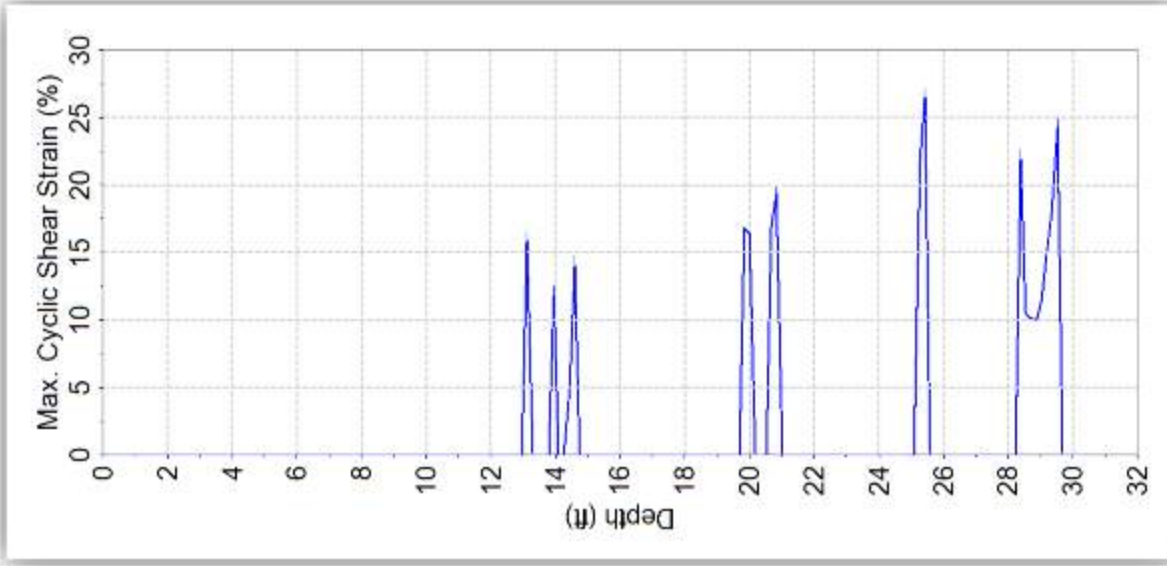
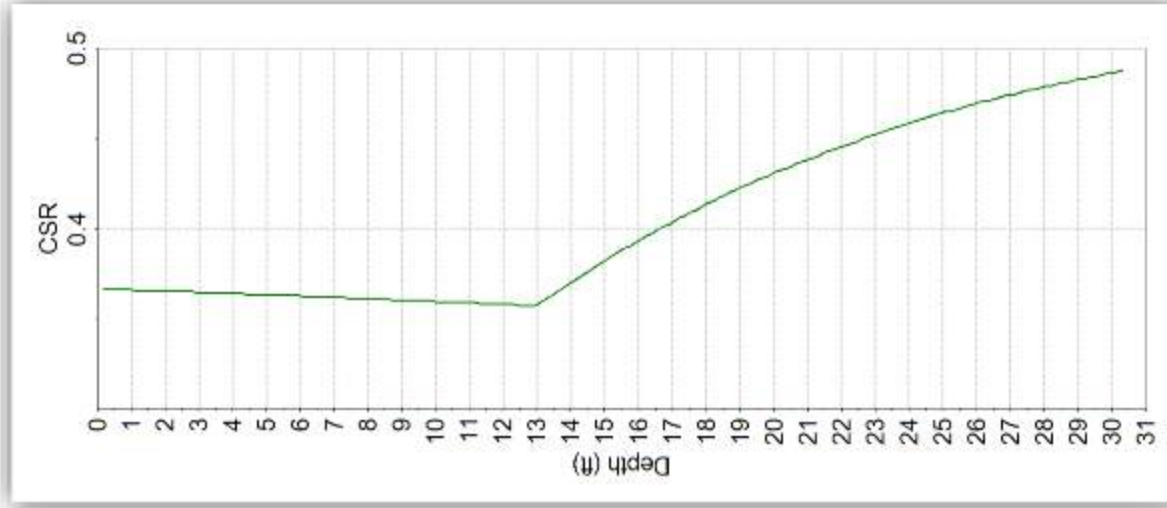
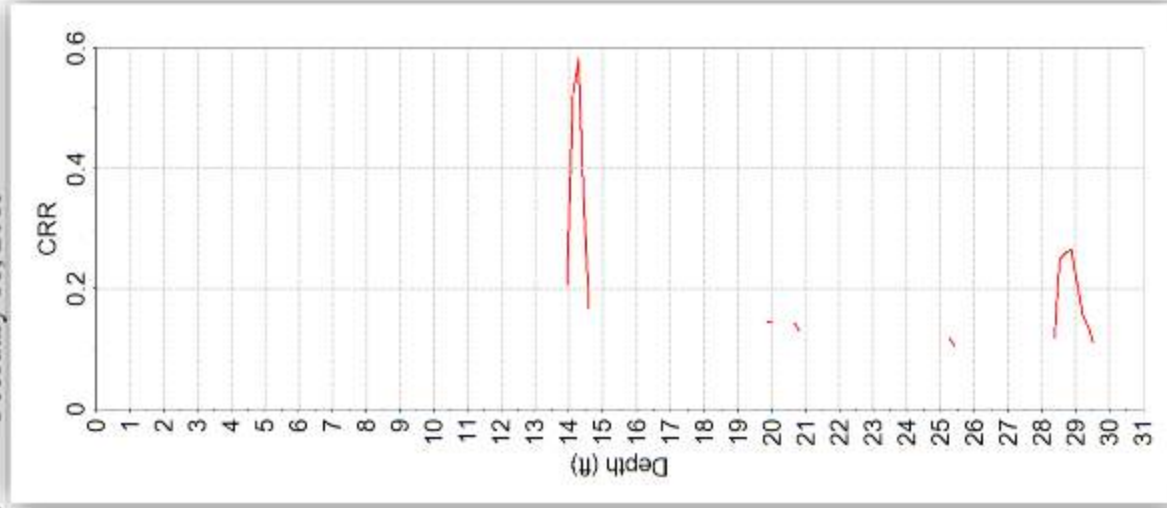

Project No: 14034

Project: Trembley Lane Subdivision

Date: February 18, 2015

Borehole No: CPT-6

Groundwater Level: 13 Feet

Cone Area Ratio: 0.8

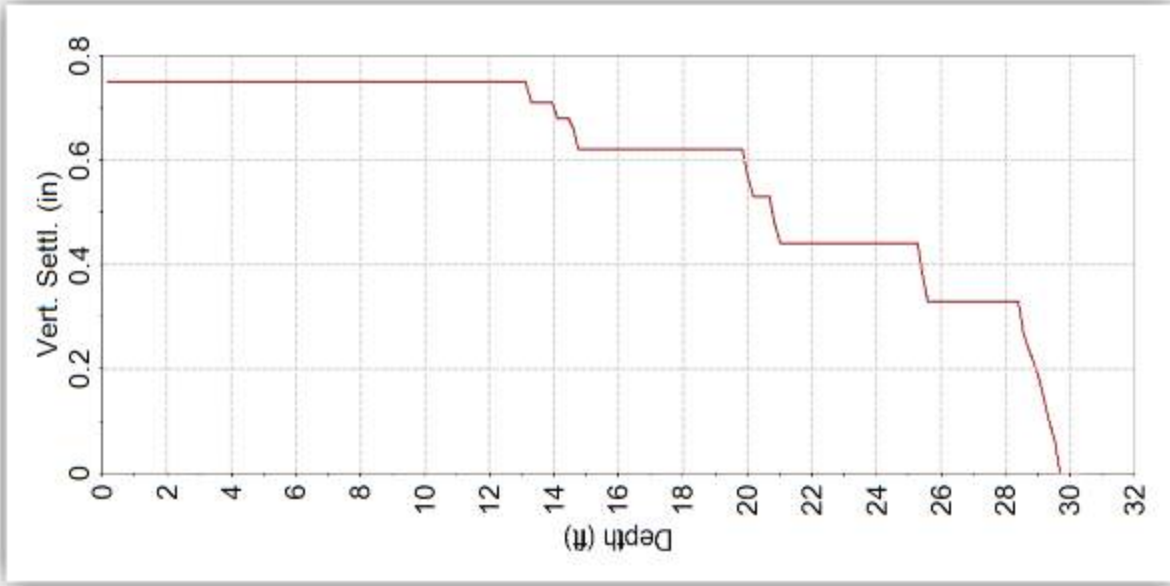
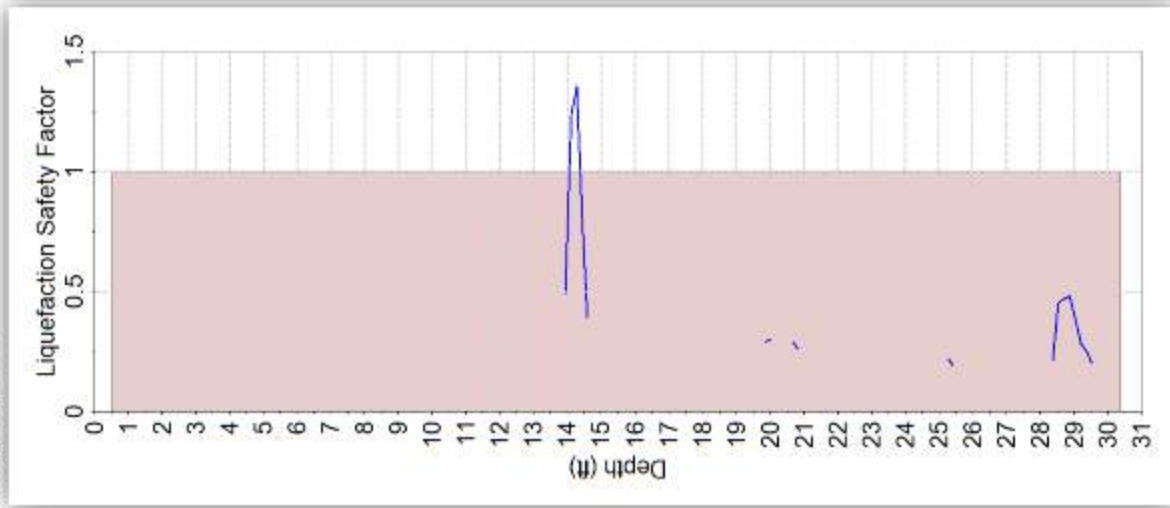

LIQUEFACTION RESULTS

Trembley Lane, Watsonville

FIGURE

B-6.2



COUNTY OF SANTA CRUZ

PLANNING DEPARTMENT

701 OCEAN STREET, 4TH FLOOR, SANTA CRUZ, CA 95060
(831) 454-2580 FAX: (831) 454-2131 TDD: (831) 454-2123
KATHLEEN MOLLOY PREVISICH, PLANNING DIRECTOR

1 June 2017

Raeid Farhat
734 East Lake Avenue #9
Watsonville, CA 95076

Subject: Review of the Geotechnical Investigation dated 6 December 2016 by Rock Solid Engineering, Inc - Project No. 14034; and

Review of the Engineering Geology Report dated 9 December 2016 and the Supplemental Analysis dated 12 May 2017 by Easton Geology, Inc - Job No. G15021

Project Site: Trembly Lane
APN 051-411-20
Application No. REV171005

Dear Applicant:

The purpose of this letter is to inform you that the Planning Department *has accepted* the subject reports. The following items shall be required:

1. All project design and construction shall comply with the recommendations of the reports, and the reports' recommendations shall be incorporated into the conditions of the discretionary permit.
2. Final plans shall reference the reports by titles, authors, and dates. Final plans should include a statement that the project shall conform to the reports' recommendations.
3. After plans are prepared that are acceptable to all reviewing agencies, please submit completed Soils (Geotechnical) Engineer and Geologist Plan Review forms to Environmental Planning. The authors of the soils and geologic reports shall sign and stamp the completed forms. Please note that the plan review forms must reference the final plan set by last revision date.
4. Geologically Suitable Building Envelopes must be designated on the tentative and final maps (SCCC 16.10.070 E (7)). These envelopes must be designated in a manner to distinguish them from other restricted areas.
5. A Development Envelope must be designated on the Final Map indicating the limits of disturbance.

Review of the Geotechnical Investigation dated 6 December 2016 by Rock Solid Engineering, Inc - Project No. 14034; and

Review of the Engineering Geology Report dated 9 December 2016 and the Supplemental Analysis dated 12 May 2017 by Easton Geology, Inc - Job No. G15021

APN 051-411-20

1 June 2017

Page 2 of 4

6. All geologic hazard zones must be designated on the final map (SCCC 14.01.208 (C) 9).
7. All riparian corridors and required setbacks shall be clearly designated on the final map (SCCC 14.01.208 (C) 8).
8. The names of the geotechnical engineer and engineering geologist shall be noted on the Final Map. A note on the final map shall state that engineering geology and geotechnical engineering reports should be read in their entirety in order to ascertain their importance (SCCC 14.01.208 (C) 2).
9. The geotechnical engineer shall provide pavement design(s), and inspection for all aspects of the grading and paving operations. The paving must be completed in conformance to Section 5.6 of the SCC Design Manual, and the geotechnical engineer shall inspect and test the grading, the preparation of the base and subgrade, and the actual paving of the roadway surface.
10. Before design of the site improvements, the geotechnical engineer must modify their soils report to reflect the comments in the Supplemental Analysis letter by Easton Geology, Inc. dated May 12, 2017. Based on the application date of 18 January 2017, the soils report should also be updated to the 2016 California Building Code. Please submit two hard copies of the updated soils report as well as an electronic copy to Environmental Planning.
11. Before the design of the site improvements, the project engineering geologist shall assist the project engineer in developing any necessary mitigation for liquefaction and lateral spreading.
12. Utilities shall be designed to withstand the potential hazards due to liquefaction and lateral spreading.

Any updates to the recommendations in the reports necessary to address conflicts between the reports and plans must be provided via a separate addendum to the soils report and/or geologic report.

Electronic copies of all forms required to be completed by the Geotechnical Engineer may be found on our website: www.sccoplanning.com, under "Environmental", "Geology & Soils", and "Assistance & Forms".

After building permit issuance the soils engineer and geologist *must remain involved with the project* during construction. Please review the Notice to Permits Holders (attached).

Our acceptance of the reports is limited to their technical content. Other project issues such as zoning, fire safety, septic or sewer approval, etc. may require resolution by other agencies.

Please note that this determination may be appealed within 14 calendar days of the date of service. Additional information regarding the appeals process may be found online at: http://www.sccoplanning.com/html/devrev/plnappeal_bldg.htm

Review of the Geotechnical Investigation dated 6 December 2016 by Rock Solid Engineering, Inc - Project No. 14034; and

Review of the Engineering Geology Report dated 9 December 2016 and the Supplemental Analysis dated 12 May 2017 by Easton Geology, Inc - Job No. G15021

APN 051-411-20

1 June 2017

Page 3 of 4

If we can be of any further assistance, please contact Rick Parks at (831) 454-3168 or rick.parks@santacruzcounty.us, or Joseph Hanna at (831) 454-3175 or by email at joseph.hanna@santacruzcounty.us

Sincerely,



Rick Parks, GE 2603
Civil Engineer – Environmental Planning

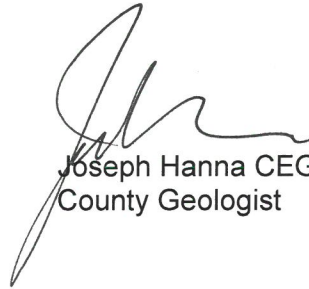

Joseph Hanna CEG 1313
County Geologist

Cc: Environmental Planning, Attn: Bob Loveland
Rock Solid Engineering, Inc.
Easton Geology, Inc.

Attachments: Notice to Permit Holders

Review of the Geotechnical Investigation dated 6 December 2016 by Rock Solid Engineering, Inc - Project No. 14034; and

Review of the Engineering Geology Report dated 9 December 2016 and the Supplemental Analysis dated 12 May 2017 by Easton Geology, Inc - Job No. G15021

APN 051-411-20

1 June 2017

Page 4 of 4

**NOTICE TO PERMIT HOLDERS WHEN A SOILS REPORT HAS BEEN PREPARED,
REVIEWED AND ACCEPTED FOR THE PROJECT**

After issuance of the building permit, *the County requires your soils engineer and engineering geologist to be involved during construction.* Several letters or reports are required to be submitted to the County at various times during construction. They are as follows:

1. **When a project has engineered fills and / or grading**, a letter from your soils engineer must be submitted to the Environmental Planning section of the Planning Department prior to foundations being excavated. This letter must state that the grading has been completed in conformance with the recommendations of the soils report. Compaction reports or a summary thereof must be submitted.
2. **Prior to placing concrete for foundations**, a letter from the soils engineer must be submitted to the building inspector and to Environmental Planning stating that the soils engineer has observed the foundation excavation and that it meets the recommendations of the soils report.
3. **At the completion of construction**, a Soils (Geotechnical) Engineer Final Inspection form and a Geologist Final Inspection form are required to be submitted to Environmental Planning that includes copies of all observations and the tests the soils engineer has made during construction and is stamped and signed, certifying that the project was constructed in conformance with the recommendations of the soils report.

If the Final Inspection forms identify any portions of the project that were not observed by the project soils engineer or geologist, you may be required to perform destructive testing in order for your permit to obtain a final inspection. The soils engineer then must complete and initial the Exceptions Addendum that certifies that the features not observed will not pose a life safety risk to occupants.

CITY OF WATSONVILLE

"Opportunity through diversity; unity through cooperation"



May 21, 2014

Raeid Farhat
734 E. Lake Avenue, No. 9
Watsonville, CA 95076

**SUBJECT: WATER AVAILIBITY LETTER FOR A RESIDENTIAL SUBDIVISION LOCATED
AT 70 TREMBLY ROAD – APN 051-411-20**

Dear Mr. Farhat:

At its May 13, 2014 meeting, the City Council adopted Resolution No. 55-14(CM) approving the issuance of a water availability letter for a 12 unit residential subdivision at the 2.30 acre parcel approximately addressed 70 Trembly Lane (APN 051-411-20). New water services will be furnished provided the following conditions are met:

1. Permits for the new residences are issued and addresses are assigned by the County of Santa Cruz;
2. An extraterritorial utility service permit is issued for the new water services by the Santa Cruz County Local Area Formation Commission; and
3. Complete a water service application and pay all water connection fees, water construction fees and impact fees.

Please contact me at 768-3076 if you have any questions.

Sincerely,

A handwritten signature in blue ink, which appears to read "Tom Sharp", is written over the typed name.

Tom Sharp
Senior Engineering Associate



Roper Engineering

Civil Engineering & Land Surveying

48 Mann Avenue – Corralitos, CA 95076-1114
(831) 724-5300 phone
jeff@roperengineering.com e-mail

Jeff A. Roper
Civil Engineer & Land Surveyor
RCE 41081
PLS 5180

PRELIMINARY STORMWATER MANAGEMENT REPORT

For

Tract No. 1582 Lakeview Estates

Trembley Lane
Watsonville, CA 95076

APN 051-411-20
Job No. 14036
March 22, 2022



Jeff Roper

Project Description

The property is located at the end of Trembley Lane off Green Valley Road in Watsonville at the intersection of Cunningham Way. This project consists of a 8 lot subdivision, the construction of 8 new residences and a new private cul-de-sac street. This project is located in Zone 7 Flood Control District.

Existing Site Conditions

The existing site conditions are represented on the Civil Plans attached. The development site is vacant with pasture grass and oak trees. The property slopes from the northwest corner towards the south and east boundaries at between 5% and 13% slope.

Upstream Runoff

The project site will receive upstream runoff from a small area of the Trembley Lane pavement (~1650 ± sf). The properties to the north, east, south and west all drain away from the property.

Drainage Mitigation

Detention systems are proposed for stormwater mitigation, see civil plans. Drainage map and calculations are attached to this report. Due to the low permeability of the onsite soils and high ground water, onsite retention of stormwater is not feasible. Contech Filterra Biofiltrateion Vaults are proposed to filter the storm water runoff before reaching the detention system. Stormwater detention is provided in detention pipes under the proposed cul-de-sac. See attached detention calculations.

Downstream Runoff

Runoff from the project will flow off the site to the east to the existing drainage swale at the east side of the property. The area between the property line and the existing swale is being used for agricultural purposes. At the time of our site visit, plants were being grown in containers.

Drainage from the site will sheet flow through the existing agricultural fields as the drainage currently flows. A 60" CMP culvert exists downstream along the swale at Paulsen Road before reaching College Lake. See attached drainage calculations for this existing 60" CMP culvert. The existing culvert appears to be sized adequately to handle the 100 year flow.

Drainage Observations

Perched groundwater was encountered by the soil engineer during their soils investigation. The groundwater is traveling through the sandier stratum of the onsite soils. The ground water reaches the surface at 2 locations on the property designated "Riparian Area" and "Riparian Seep". The proposed development has been setback from these areas as shown on the tentative map and preliminary plans.

No erosion or other drainage issues were observed at the site. The onsite soils are considered moderately erodible. The finish grade surfaces should be planted with erosion resistant landscaping and maintained to minimize surface erosion.

Downstream Impact Assessment

No negative drainage issues were observed on or near the project site on December 30, 2021. No drainage issues or adverse impacts are anticipated resulting from the proposed improvements. See Preliminary Civil Plans for further details.

EXISTING SITE DRAINAGE

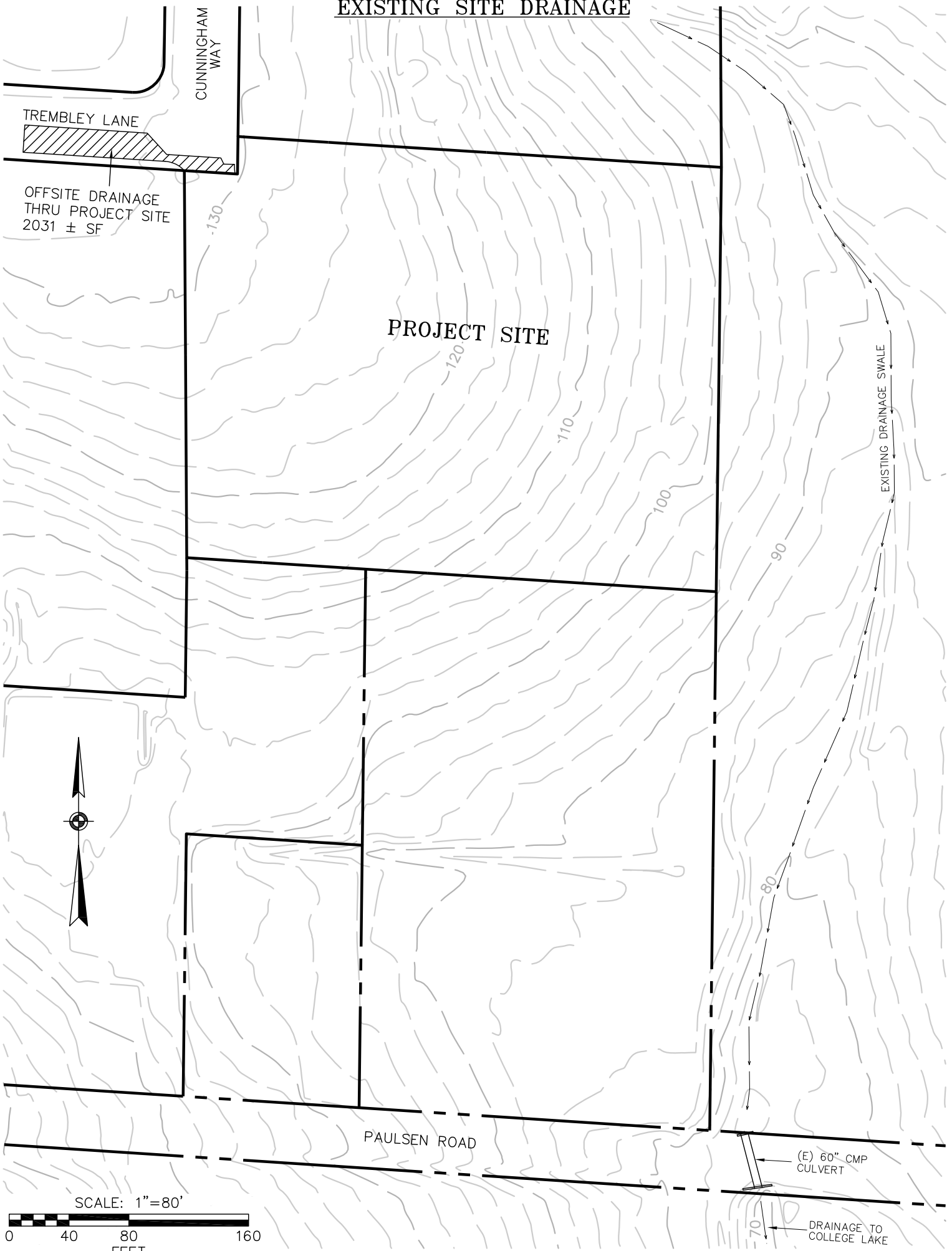

TREMBLEY LANE

CUNNINGHAM WAY

OFFSITE DRAINAGE THRU PROJECT SITE 2031 ± SF

PROJECT SITE

EXISTING DRAINAGE SWALE

PAULSEN ROAD

(E) 60" CMP CULVERT

DRAINAGE TO COLLEGE LAKE

SCALE: 1"=80'



LEGEND



NEW IMPERVIOUS SURFACE

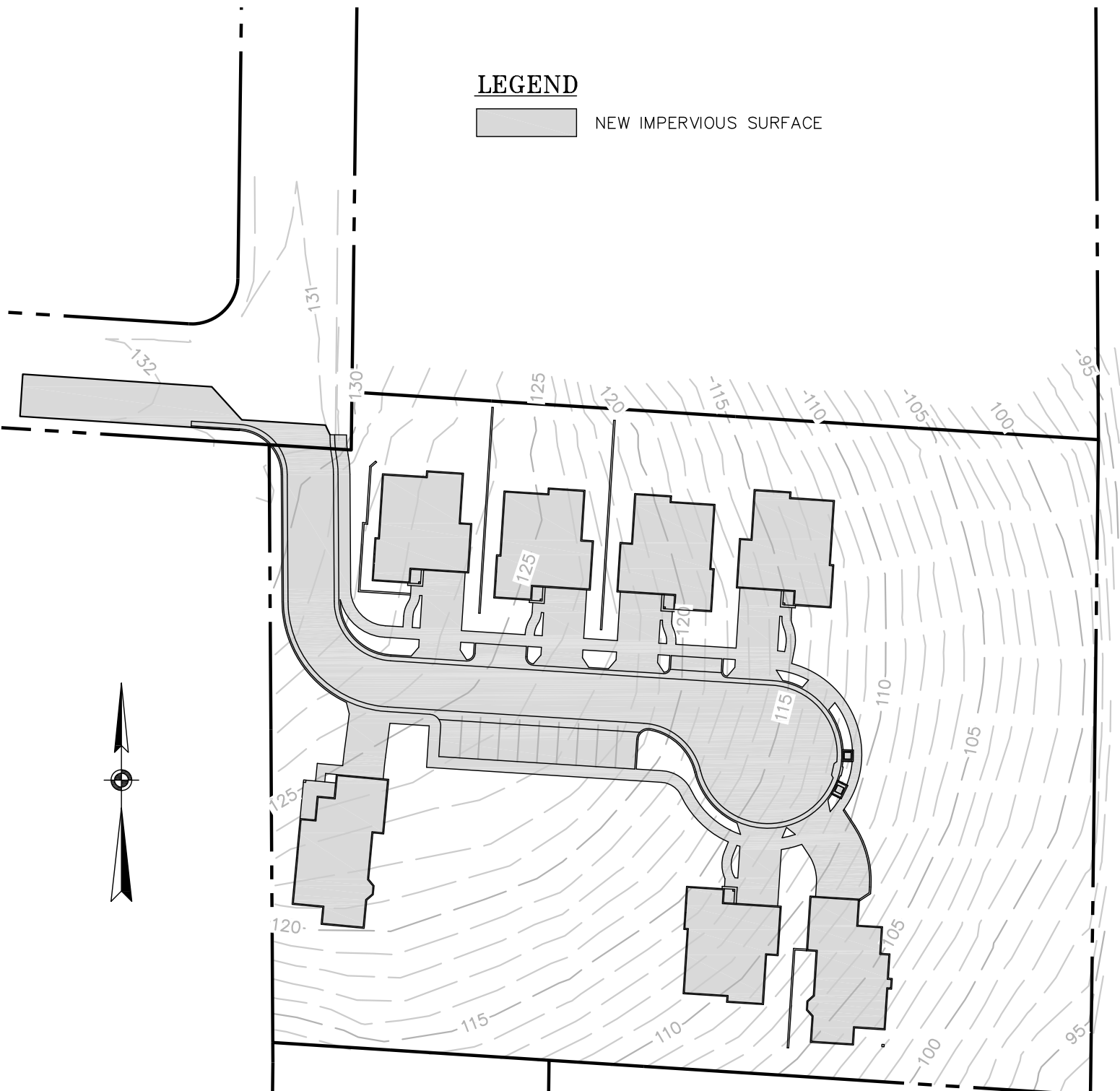

DRAINAGE AREAS

SCALE: 1"=60'



RUNOFF DETENTION BY THE MODIFIED RATIONAL METHOD

Data Entry: **PRESS TAB & ENTER DESIGN VALUES** SS Ver: 1.0

Site Location P60 Isoleth: **1.40** Fig. SWM-2 in County Design Criteria
 Rational Coefficients Cpre: **0.25** See note # 2
 Cpost: **0.90** See note # 2
 Impervious Area: **33862** ft² See note # 2 and # 4

STRUCTURE DIMENSIONS FOR DETENTION

1825 ft³ storage volume calculated
 % void space assumed
 1825 ft³ excavated volume needed

Structure Ratios	Length	Width*	Depth*	*For pipe, use the square root of the sectional area
	150.00	3.54	3.54	
Dimen. (ft)	148.54	3.51	3.51	

10 - YEAR DESIGN STORM				DETENTION @ 15 MIN.	
Storm Duration (min)	10 - Year Intensity (in/hr)	5 - Yr. Release Qpre (cfs)	10 - Year Qpost (cfs)	Detention Rate To Storage (cfs)	Specified Storage Volume (cf)
1440	0.23	0.039	0.165	-0.118	-12732
1200	0.25	0.042	0.179	-0.104	-9385
960	0.28	0.046	0.197	-0.086	-6199
720	0.32	0.053	0.223	-0.060	-3234
480	0.38	0.063	0.266	-0.017	-609
360	0.43	0.071	0.302	0.018	499
240	0.51	0.085	0.360	0.077	1378
180	0.58	0.096	0.407	0.124	1679
120	0.69	0.115	0.486	0.203	1825
90	0.78	0.130	0.551	0.267	1806
60	0.93	0.155	0.656	0.373	1681
45	1.05	0.176	0.744	0.461	1555
30	1.26	0.209	0.887	0.604	1359
20	1.50	0.250	1.058	0.775	1162
15	1.70	0.283	1.199	0.916	1030
10	2.03	0.338	1.429	1.146	860
5	2.74	0.456	1.932	1.649	618

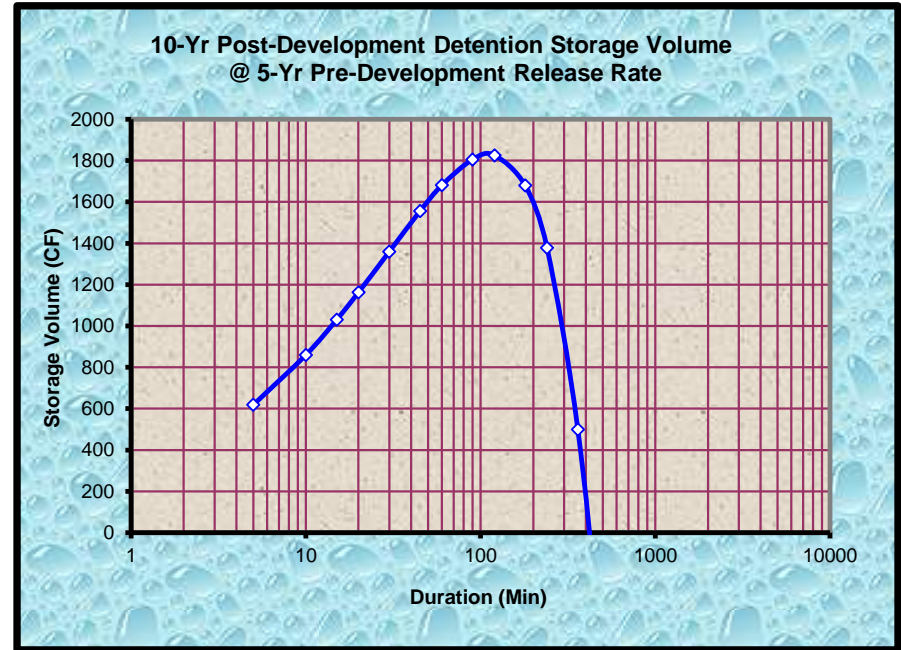

Notes & Limitations on Use:

- 1) The modified rational method, and therefore the standard calculations are applicable in watersheds up to 20 acres in size.
- 2) Required detention volume determinations shall be based on all net new impervious area both on and off-site, resulting from the proposed project. Pervious areas shall not be included in detention volume sizing; an exception may be made for incidental pervious areas less than 10% of the total area.
- 3) Gravel packed detention chambers shall specify on the plans, aggregate that is washed, angular, and uniformly graded (of single size), assuring void space not less than 35%.
- 4) A map showing boundaries of both regulated impervious areas and actual drainage areas routed to the hydraulic control structure of the detention facility is to be provided, clearly distinguishing between the two areas, and noting the square footage.
- 5) The EPA defines a class V injection well as any bored, drilled, or driven shaft, or dug hole that is deeper than its widest surface dimension, or an improved sinkhole, or a subsurface fluid distribution system. Such storm water drainage wells are "authorized by rule". For more information on these rules, contact the EPA. A web site link is provided from the County DPW Stormwater Management web page.
- 6) Refer to the County of Santa Cruz Design Criteria, for complete method criteria.

StreamStats Report

Region ID: CA
Workspace ID: CA20211227185928205000
Clicked Point (Latitude, Longitude): 36.95555, -121.75879
Time: 2021-12-27 10:59:48 -0800

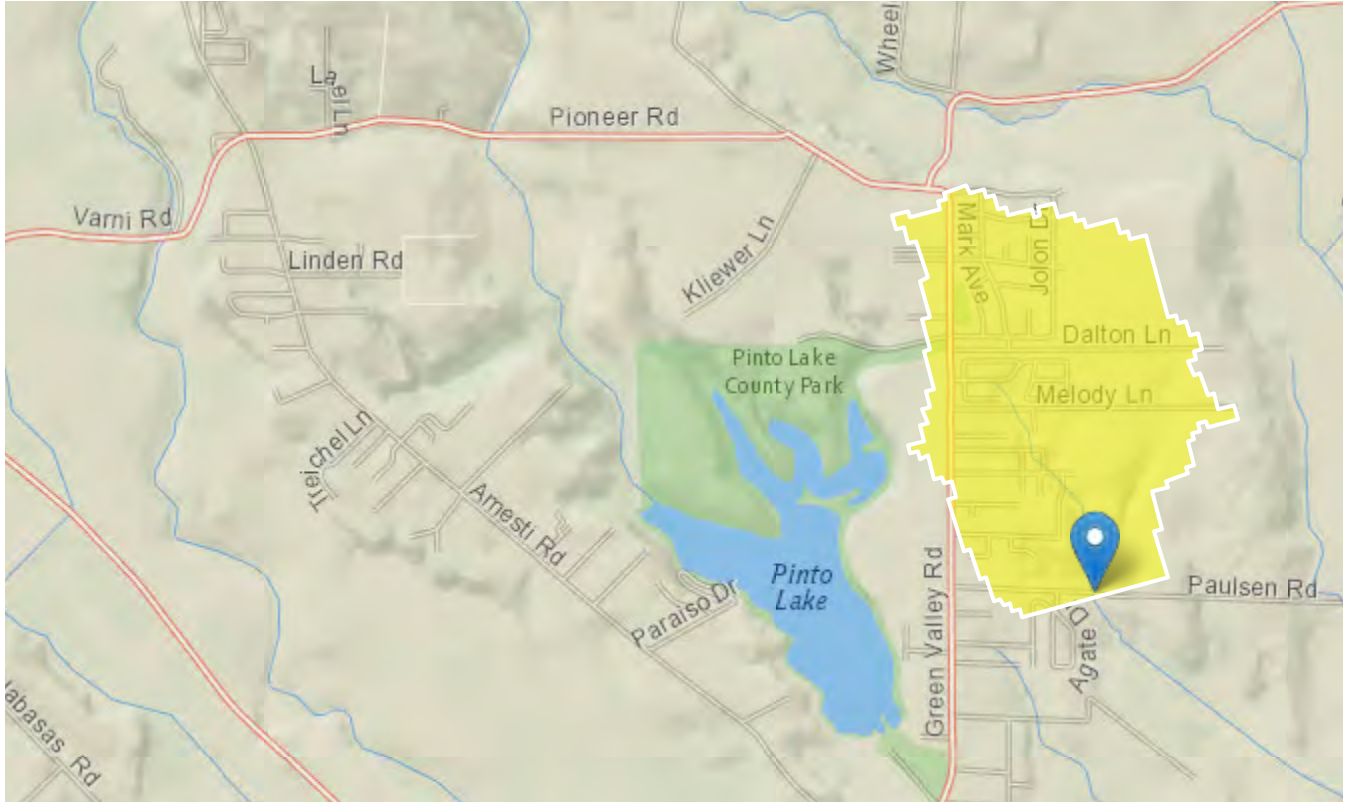

Basin Characteristics

Parameter Code	Parameter Description	Value	Unit
DRNAREA	Area that drains to a point on a stream	0.5	square miles
PRECIP	Mean Annual Precipitation	23.3	inches

Peak-Flow Statistics Parameters [99.9 Percent (0.52 square miles) 2012 5113 Region 4 Central Coast]

Parameter Code	Parameter Name	Value	Units	Min Limit	Max Limit
DRNAREA	Drainage Area	0.5	square miles	0.11	4600

Parameter Code	Parameter Name	Value	Units	Min Limit	Max Limit
PRECIP	Mean Annual Precipitation	23.3	inches	7	46

Peak-Flow Statistics Flow Report [99.9 Percent (0.52 square miles) 2012 5113 Region 4 Central Coast]

PII: Prediction Interval-Lower, Plu: Prediction Interval-Upper, ASEp: Average Standard Error of Prediction, SE: Standard Error (other -- see report)

Statistic	Value	Unit	PII	Plu	ASEp
50-percent AEP flood	8.55	ft ³ /s	1.26	58.1	162
20-percent AEP flood	26.9	ft ³ /s	6.72	108	97
10-percent AEP flood	47.6	ft ³ /s	14.5	157	79.4
4-percent AEP flood	80.8	ft ³ /s	27.2	240	69.9
2-percent AEP flood	111	ft ³ /s	39.6	311	66.2
1-percent AEP flood	141	ft ³ /s	49.9	398	66.9
0.5-percent AEP flood	173	ft ³ /s	60.9	491	67.6
0.2-percent AEP flood	216	ft ³ /s	70.9	658	71.5

Peak-Flow Statistics Citations

Gotvald, A.J., Barth, N.A., Veilleux, A.G., and Parrett, Charles, 2012, Methods for determining magnitude and frequency of floods in California, based on data through water year 2006: U.S. Geological Survey Scientific Investigations Report 2012–5113, 38 p., 1 pl. (<http://pubs.usgs.gov/sir/2012/5113/>)

USGS Data Disclaimer: Unless otherwise stated, all data, metadata and related materials are considered to satisfy the quality standards relative to the purpose for which the data were collected. Although these data and associated metadata have been reviewed for accuracy and completeness and approved for release by the U.S. Geological Survey (USGS), no warranty expressed or implied is made regarding the display or utility of the data for other purposes, nor on all computer systems, nor shall the act of distribution constitute any such warranty.

USGS Software Disclaimer: This software has been approved for release by the U.S. Geological Survey (USGS). Although the software has been subjected to rigorous review, the USGS reserves the right to update the software as needed pursuant to further analysis and review. No warranty, expressed or implied, is made by the USGS or the U.S. Government as to the functionality of the software and related material nor shall the fact of release constitute any such warranty. Furthermore, the software is released on condition that neither the USGS nor the U.S. Government shall be held liable for any damages resulting from its authorized or unauthorized use.

USGS Product Names Disclaimer: Any use of trade, firm, or product names is for descriptive purposes only and does not imply endorsement by the U.S. Government.

Culvert Report

10 Year Flow 60 inch CMP Culvert Paulsen Road

Invert Elev Dn (ft)	= 66.50
Pipe Length (ft)	= 37.50
Slope (%)	= 2.51
Invert Elev Up (ft)	= 67.44
Rise (in)	= 60.0
Shape	= Circular
Span (in)	= 60.0
No. Barrels	= 1
n-Value	= 0.011
Culvert Type	= Circular Corrugate Metal Pipe
Culvert Entrance	= Headwall
Coeff. K,M,c,Y,k	= 0.0078, 2, 0.0379, 0.69, 0.5

Embankment	
Top Elevation (ft)	= 76.50
Top Width (ft)	= 23.00
Crest Width (ft)	= 50.00

Calculations	
Qmin (cfs)	= 47.60
Qmax (cfs)	= 47.60
Tailwater Elev (ft)	= Normal

Highlighted	
Qtotal (cfs)	= 47.60
Qpipe (cfs)	= 47.60
Qovertop (cfs)	= 0.00
Veloc Dn (ft/s)	= 11.33
Veloc Up (ft/s)	= 6.81
HGL Dn (ft)	= 67.83
HGL Up (ft)	= 69.37
Hw Elev (ft)	= 70.07
Hw/D (ft)	= 0.53
Flow Regime	= Inlet Control

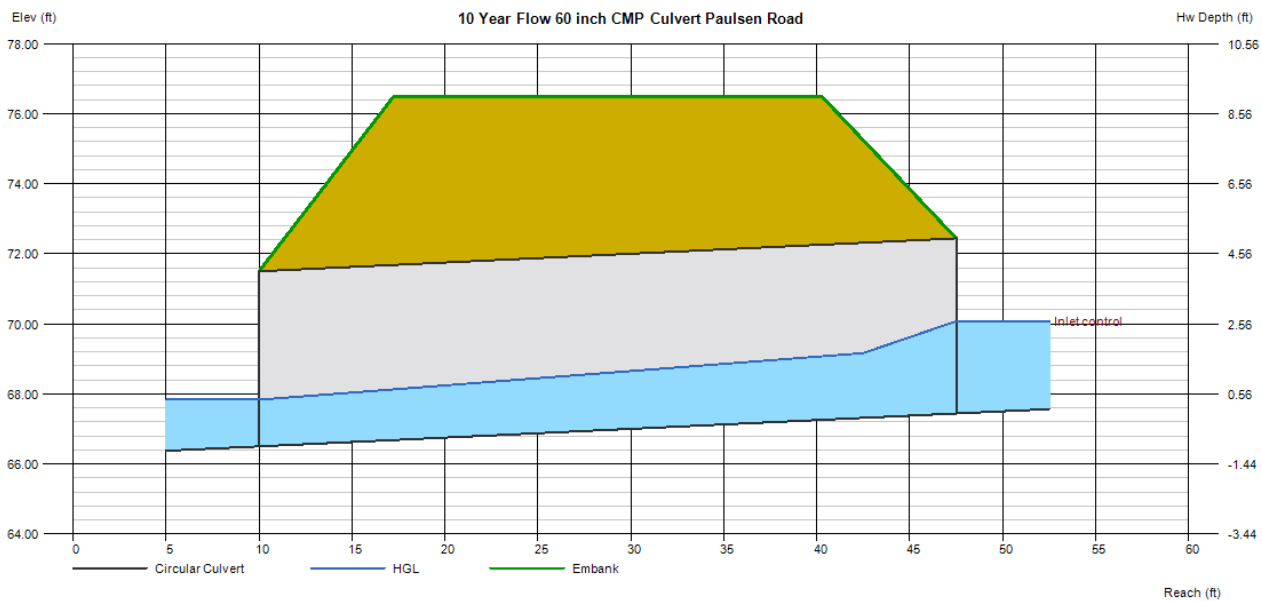

Culvert Report

100 Year Flow 60 inch CMP Culvert Paulsen Road

Invert Elev Dn (ft) = 66.50
 Pipe Length (ft) = 37.50
 Slope (%) = 2.51
 Invert Elev Up (ft) = 67.44
 Rise (in) = 60.0
 Shape = Circular
 Span (in) = 60.0
 No. Barrels = 1
 n-Value = 0.011
 Culvert Type = Circular Corrugate Metal Pipe
 Culvert Entrance = Headwall
 Coeff. K,M,c,Y,k = 0.0078, 2, 0.0379, 0.69, 0.5

Embankment
 Top Elevation (ft) = 76.50
 Top Width (ft) = 23.00
 Crest Width (ft) = 50.00

Calculations
 Qmin (cfs) = 173.00
 Qmax (cfs) = 173.00
 Tailwater Elev (ft) = Normal

Highlighted
 Qtotal (cfs) = 173.00
 Qpipe (cfs) = 173.00
 Qovertop (cfs) = 0.00
 Veloc Dn (ft/s) = 10.90
 Veloc Up (ft/s) = 10.90
 HGL Dn (ft) = 70.27
 HGL Up (ft) = 71.21
 Hw Elev (ft) = 73.77
 Hw/D (ft) = 1.27
 Flow Regime = Inlet Control

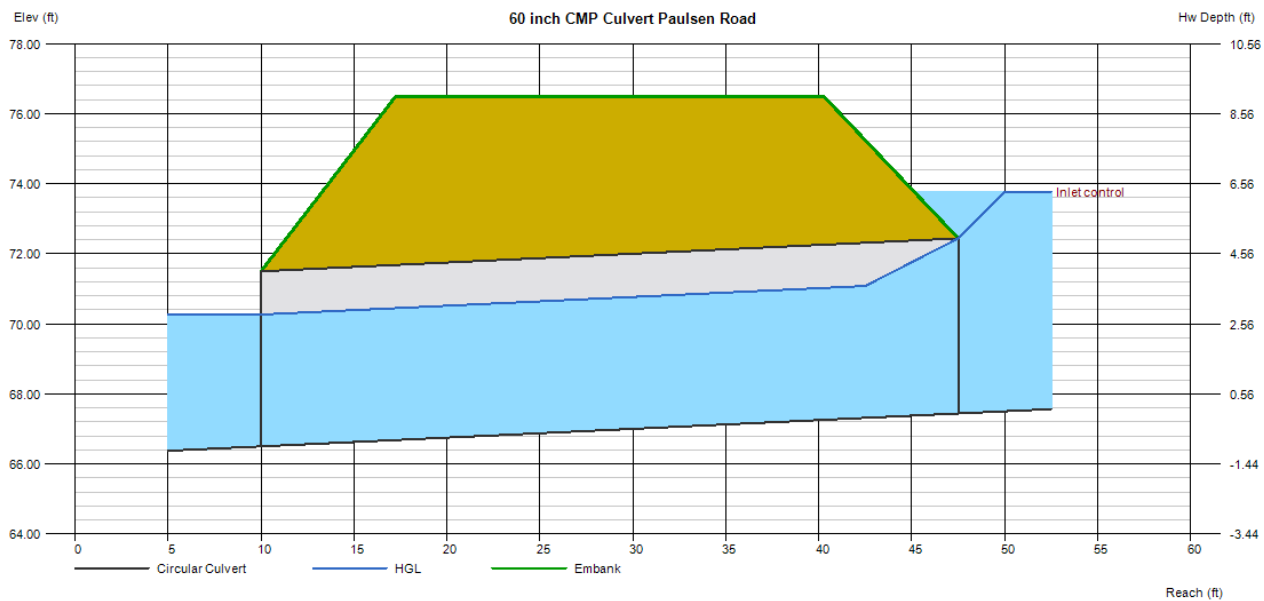



County of Santa Cruz

DEPARTMENT OF PUBLIC WORKS

701 OCEAN STREET, ROOM 410, SANTA CRUZ, CA 95060-4070
(831) 454-2160 FAX (831) 454-2385 TDD (831) 454-2123

MATT MACHADO
DEPUTY CAO
DIRECTOR OF PUBLIC WORKS

12/22/2020

EADIE CONSULTANTS

Charles Eadie
P.O. Box 1647
Santa Cruz, CA 95061

SUBJECT: SEWER AVAILABILITY AND DISTRICT'S CONDITIONS OF SERVICE FOR THE FOLLOWING PROPOSED DEVELOPMENT

APN: 051-411-20

APPLICATION NO.: n/a

PARCEL ADDRESS: n/a

PROJECT DESCRIPTION: SUBDIVIDE AND DEVELOP A VACANT LOT INTO 8 SINGLE FAMILY DWELLING UNITS

Dear Mr. Eadie:

The Freedom County Sanitation District has received your inquiry regarding sewer service availability at the subject parcel. As we have discussed previously, this property is located within the District's Sphere of Influence but outside the District boundaries; therefore, the District is not authorized to provide sewer service to this property at this time. You may apply to the Local Area Formation Commission (LAFCO) to seek annexation into the District proper. (Freedom County Sanitation District Code Article IX)

LAFCO's office is located at 701 Ocean Street, Room 318-D. You can reach them by phone at (831) 454-2055.

Assuming that annexation of this parcel into the Freedom County Sanitation District is approved, sewer service is available in Trembley Ln and Cunningham Wy. No downstream capacity problem or other issue is known at this time. Note, however, that downstream sewer requirements will again be evaluated at time of Planning Application review, at which time the District reserves the right to add or modify downstream sewer requirements, though none are anticipated at this time.

This notice is valid for one year from the date of this letter. If, after this time frame, this project has not yet received approval from LAFCO and the Sanitation District Board, then this determination of availability will be considered to have expired. If that occurs or is likely to

occur prior to an upcoming submittal or public hearing, please call us ahead of time for a new letter. At that time, we can evaluate the then proposed use, improvements, and downstream capacity, and provide a new letter.

Also, for your reference, we have attached a list of common items required during the review of sanitation projects.

Thank you for your inquiry. If you have any questions, please call Bryan Wardlow at (831) 454-2160.

Yours truly,

MATT MACHADO
District Engineer

By:

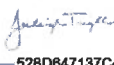
DocuSigned by:

528D647137C44D4...
Ashleigh Trujillo
Sanitation Engineer

BW:jv

05141120 Sewer Availability Letter.doc